



Where Automation Connects.



ILX69-PBM

**CompactLogix™ or MicroLogix™
Platform**

PROFIBUS Master Communication
Module

November 9, 2020

USER MANUAL

Your Feedback Please

We always want you to feel that you made the right decision to use our products. If you have suggestions, comments, compliments or complaints about our products, documentation, or support, please write or call us.

ProSoft Technology, Inc.

+1 (661) 716-5100

+1 (661) 716-5101 (Fax)

www.prosoft-technology.com

support@prosoft-technology.com

© 2020 ProSoft Technology, Inc. All rights reserved.

ILX69-PBM User Manual

November 9, 2020

ProSoft Technology® is a registered copyright of ProSoft Technology, Inc. All other brand or product names are or may be trademarks of, and are used to identify products and services of, their respective owners.

ProSoft Technology® Product Documentation

In an effort to conserve paper, ProSoft Technology no longer includes printed manuals with our product shipments. User Manuals, Datasheets, Sample Ladder Files, and Configuration Files are provided at:
www.prosoft-technology.com

Important Safety Information

WARNING - EXPLOSION HAZARD - SUBSTITUTION OF COMPONENTS MAY IMPAIR SUITABILITY FOR CLASS I, DIV. 2;

WARNING - EXPLOSION HAZARD - WHEN IN HAZARDOUS LOCATIONS, TURN OFF POWER BEFORE REPLACING OR WIRING MODULES

WARNING - EXPLOSION HAZARD - DO NOT DISCONNECT EQUIPMENT UNLESS POWER HAS BEEN SWITCHED OFF OR THE AREA IS KNOWN TO BE NON-HAZARDOUS.

Class 2 Power



For professional users in the European Union

If you wish to discard electrical and electronic equipment (EEE), please contact your dealer or supplier for further information.



Prop 65 Warning – Cancer and Reproductive Harm – www.P65Warnings.ca.gov

Agency Approvals & Certifications

Please visit our website: www.prosoft-technology.com

Contents

Your Feedback Please	2
ProSoft Technology® Product Documentation	2
Important Safety Information	2
1 Introduction	6
1.1 About the User Manual	6
1.1.1 Intended Audience	6
1.2 General Information	6
1.3 Reference Systems	7
1.4 1769 Programmable Controller Functionality	8
1.5 Requirements.....	8
1.5.1 Software Requirements	8
1.5.2 System Requirements	9
1.5.3 Hardware Requirements.....	9
2 Safety	10
2.1 General Note.....	10
2.2 Personnel Qualification.....	10
2.3 Safety Instructions to Avoid Personal Injury	10
2.3.1 Electrical Shock Hazard.....	10
2.3.2 Communication Stop During Firmware Update	11
2.4 Safety Instructions to Avoid Property Damage.....	12
2.4.1 Device Destruction if ILX69-PBM is Installed to Powered PLC.....	12
2.4.2 Device Destruction by Exceeding Allowed Supply Voltage	12
2.4.3 Device Destruction by Exceeding Allowed Signaling Voltage	12
2.4.4 Electrostatically sensitive devices.....	13
2.5 Labeling of Safety Messages.....	14
2.6 Safety References	15
3 About the ILX69-PBM	16
3.1 Device Drawing.....	16
3.2 PROFIBUS Interface	17
3.2.1 Wiring Instructions	17
3.3 Ethernet Interface	19
3.3.1 Ethernet Pin Assignment at the RJ45 Socket.....	19
3.3.2 Ethernet Connection Data	19
3.4 Removable Memory Card.....	20
3.5 Power Supply.....	20
4 Installation	21
4.1 System Planning Considerations.....	21
4.2 Software Installation	22
4.2.1 Installing ProSoft fdt Configuration Manager in Windows 7	22

4.3	ILX69-PBM Hardware Installation.....	24
4.3.1	Safety Precautions.....	24
4.3.2	Installing the ILX69-PBM Module	25
4.4	Uninstalling ILX69-PBM Hardware	25
5	Configuration and Start-Up	26
5.1	CompactLogix Project.....	26
5.1.1	Creating a New Project.....	26
5.1.2	Module Properties 1.....	29
5.1.3	Module Properties 2.....	30
5.1.4	Importing the Ladder Rung	31
5.2	ProSoft fdt Configuration Manager	34
5.2.1	Creating a New ILX69-PBM Project	34
5.2.2	PROFIBUS Master Configuration	36
5.2.3	PROFIBUS Slave Configuration	37
5.3	Downloading the Project to the ILX69-PBM	42
5.3.1	Assigning an IP Address.....	42
5.3.2	Downloading the Project.....	44
5.4	Adjusting Input/Output Data Lengths in the Project	48
5.4.1	Determining the Number of PROFIBUS Inputs/Outputs Used	48
5.4.2	Studio 5000 Adjustment (Optional).....	49
5.5	Copying and Moving a Project.....	52
5.6	Project Storage	53
5.6.1	Store Function.....	54
5.6.2	Restore Function	54
5.6.3	Project File Backup and SD Card Handling.....	55
5.6.4	Start-up Behavior with or without SD Card	57
5.6.5	STARTUP.INI File.....	58
5.6.6	Reset Device to Factory Settings with Memory Card	58
6	Communication	59
6.1	Studio 5000 PROFIBUS Data Values	59
6.1.1	PROFIBUS Network Input Data.....	59
6.1.2	PROFIBUS Network Output Data.....	59
6.2	I/O Communication and Memory Map	60
6.2.1	I/O Arrays Overview.....	60
6.2.2	Input Array	61
6.2.3	Output Array.....	73
6.3	Acyclic Messaging	78
6.3.1	Supported PROFIBUS DP Messages	78
6.3.2	Standard Messaging.....	78
6.3.3	DPV1 Messaging	81
6.3.4	CIP Message Error Codes.....	84
7	Diagnostics and Troubleshooting	88
7.1	Webpage.....	88
7.1.1	General Device and Diagnosis Information	89
7.1.2	Firmware Update	95
7.2	Hardware LEDs.....	101
7.2.1	CompactLogix LEDs	101

7.2.2	ILX69-PBM LEDs.....	102
7.3	Troubleshooting	104
8	Technical Data	105
<hr/>		
8.1	Technical Data - ILX69-PBM	105
8.2	Technical Data - PROFIBUS	107
9	Annex	108
<hr/>		
9.1	PROFIBUS Functionality	108
9.1.1	DPV0 Services.....	108
9.1.2	DPV1 Services.....	109
9.2	Disposal of Electronic Equipment Waste.....	110
9.3	References.....	110
9.4	Glossary.....	111
10	Support, Service & Warranty	113
<hr/>		
10.1	Contacting Technical Support.....	113
10.2	Warranty Information	113

1 Introduction

1.1 About the User Manual

This user manual provides descriptions and detailed information about:

- How to assemble the ILX69-PBM into a CompactLogix™ system.
- PROFIBUS wiring
- Configuration and start-up
- Communication
- Diagnostics
- LED displays
- Technical data and electrical/environmental specifications

1.1.1 *Intended Audience*

The intended audiences for this manual are the individuals responsible for designing, installing, programming, or troubleshooting control systems that use the Rockwell CompactLogix™ 1769 programmable controller and the ILX69-PBM. You should have a basic understanding of electrical circuitry and familiarity with relay logic. If you do not, obtain the proper training before using this product.

1.2 General Information

The ILX69-PBM is a PROFIBUS DP master module for the CompactLogix™ platform which allows the PLC to control data exchange on a PROFIBUS network. The ILX69-PBM handles the cyclic data exchange between the connected PROFIBUS slaves.

The data exchange between the CompactLogix™ controller and the ILX69-PBM is done via the I/O process data image using CompactLogix™ backplane technology. The process image of the CompactLogix™ and of the ILX69-PBM is updated automatically during runtime.

The configuration and diagnostics of the ILX69-PBM is done using the **ProSoft fdt Configuration Manager** software over an Ethernet connection. The configuration is stored permanently using the on-board FLASH memory of the ILX69-PBM and is available immediately on power up. ProSoft fdt Configuration Manager allows you to backup the configuration project files from the internal flash memory to an inserted SD memory card. Basic diagnostics of the ILX69-PBM can be done via its Webpage.

ProSoft fdt Configuration Manager

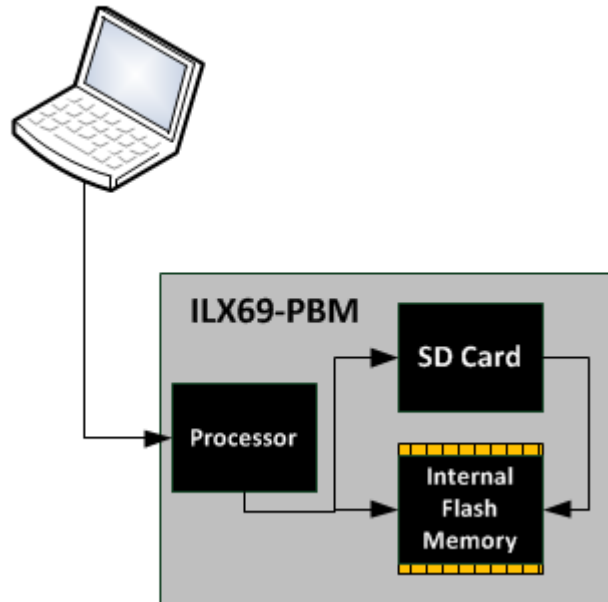

1.3 Reference Systems

The firmware of the ILX69-PBM was developed and tested with the following CompactLogix™ controller types and firmware revisions.

CompactLogix System

Controller	Firmware
CompactLogix™ 1769-L23	V17.05
CompactLogix™ 1769-L32E	V20.13
CompactLogix™ 1769-L36ERM	V21.11

1.4 1769 Programmable Controller Functionality

PROFIBUS DP supports acyclic services through messages. These PROFIBUS DP services are supported by the Studio 5000 programming tool using CIP messages. Not all of the 1769 programmable controllers support CIP messaging.

The basic PROFIBUS DP acyclic services Global Control or slave Diagnostics request are also executable in addition to the CIP method by using the I/O area. The following table displays the 1769 programmable controllers and the functionalities they support.

CompactLogix System

Processor	I/O (cyclic)	CIP Messaging (acyclic)
CompactLogix™ 5370 L2x and L3x	Yes	Yes
CompactLogix™ 1769-L23	Yes	Yes
CompactLogix™ 1769-L24x *	Yes	Yes
CompactLogix™ 1769-L30	Yes	No
CompactLogix™ 1769-L31	Yes	Yes
CompactLogix™ 1769-L32E	Yes	Yes
CompactLogix™ 1769-L33ER	Yes	Yes
CompactLogix™ 1769-L35E	Yes	Yes
CompactLogix™ 1769-L36ERM	Yes	Yes

(*) Only one ILX69-PBM is supported on the bus due to power restrictions.

Yes = Functionality supported

No = Functionality not supported

1.5 Requirements

1.5.1 Software Requirements

The software requirements for using the ILX69-PBM within a CompactLogix™ system are listed below. You must have the following software installed on your PC unless otherwise noted:

CompactLogix System

- Studio 5000 programming software, V21.00 or higher
- RSLogix™ 5000 programming software, V20.00 or higher

ProSoft Configuration Software

- **ProSoft fdt Configuration Manager** for Rockwell Interfaces V1.0.x.x or higher

1.5.2 System Requirements

ProSoft fdt Configuration Manager software

- PC with 1 GHz processor or higher
- Windows® 7 (32 bit) SP1, Windows® 7 (64 bit) SP1, Windows® XP (32 bit) SP3
- Administrator privilege required for installation
- Internet Explorer 5.5 or higher
- The software Microsoft .NET Framework 3.5 or 4.0 (Included in the ProSoft fdt Configuration Manager installation package)
- Free disk space: minimum 400 MB
- RAM: minimum 512 MB, recommended 1024 MB
- Graphic resolution: minimum 1024 x 768 pixel
- Keyboard and Mouse



Note: If the solution file is saved and opened again, or if the solution file is used on another PC, the system requirements must match. Particularly, the DTM must be installed on the used PC.

Restrictions

- Touch screen is not supported.
- When ProSoft fdt Configuration Manager is installed on a PC, Hilscher standard SYCON.net and legacy PROSOFT.fdt cannot be and shall not be installed, and vice-versa.

1.5.3 Hardware Requirements

The following minimum hardware is required to use the ILX69-PBM:

- Windows PC for the ProSoft fdt Configuration Manager software (advantageous with SD card slot or SD card reader). Refer to section System Requirements (page 9).
- Ethernet cable for ProSoft fdt Configuration Manager or ILX69-PBM Webpage connection.

CompactLogix System

- Personal Computer
- 1769 – Programmable controller (1769-L23, 1769-L32E and 1769-L36ERM)
- 1769 – Power supply
- 1769 – Right or left termination end cap
- Ethernet cable for interface to the 1769 programmable controller.

2 Safety

2.1 General Note

The documentation in the form of a user manual, an operating instruction manual or other manual types, as well as the accompanying texts have been created for the use of the products by educated personnel. When using the products, all Safety Messages, Integrated Safety Messages, Property Damage Messages and all valid legal regulations must be obeyed. Technical knowledge is presumed. The user must assure that all legal regulations are obeyed.

2.2 Personnel Qualification

The ILX69-PBM must only be installed, configured, and removed by qualified personnel. Job-specific technical skills for people professionally working with electricity must be present concerning the following topics:

- Safety and health at work
- Mounting and connecting of electrical equipment
- Measurement and analysis of electrical functions and systems
- Evaluation of the safety of electrical systems and equipment
- Installing and configuring IT systems

2.3 Safety Instructions to Avoid Personal Injury

To ensure your own personal safety and to avoid personal injury, you necessarily must read, understand and follow the safety instructions and safety messages in this manual before you install and operate the ILX69-PBM.

2.3.1 *Electrical Shock Hazard*

The danger of a lethal electrical shock caused by parts with more than 50V may occur if you power a PLC power supply module when its housing is open.

- HAZARDOUS VOLTAGE is present inside of a powered PLC power supply module.
- Strictly obey all safety rules provided by the device manufacturer in the documentation.
- Disconnect the network power (power plug) from the power supply module before you disconnect the PLC module from the backplane.
- When you disconnect the PLC module from the power supply module, use end cap terminators and close the power supply module housing.

An electrical shock is the result of a current flowing through the human body. The resulting effect depends on the intensity and duration of the current and on its path through the body. Currents in the range of approximately ½ mA can cause effects in persons with good health, and indirectly cause injuries resulting from startling responses. Higher currents can cause more direct effects, such as burns, muscle spasms, or ventricular fibrillation.

In dry conditions, permanent voltages up to approximately 42.4 V peak or 60 V are not considered as dangerous if the contact area is equivalent to the size of a human hand. More information is located at Safety References (page 15).

2.3.2 Communication Stop During Firmware Update

If you plan a firmware update via the ProSoft Webpages, please yield:

- During the firmware update procedure, a device reset is performed and stops all module communication functions with network devices. An unintended plant stop can cause personal injury.
- Initiating a device reset causes a device reboot. A reboot stops all communication immediately.
- Personal injury by consequence of careless use caused plant stop cannot be excluded.
- All fieldbus devices should be placed in a fail-safe condition under direct supervision before starting a firmware update.
- Before you initiate a reset, make sure your system is in an idle state and operating under maintenance conditions in order to prevent personal injury.
- Stop the PLC program before you start the firmware update.

More firmware update information is located at Firmware Update (page 95).

2.4 Safety Instructions to Avoid Property Damage

To avoid system damage and device destruction to the ILX69-PBM, you necessarily must read, understand and follow the following safety instructions and safety messages in this manual before you install and operate the ILX69-PBM.

2.4.1 Device Destruction if ILX69-PBM is Installed to Powered PLC

To avoid device destruction when the ILX69-PBM is powered up:

- Strictly obey to all safety rules provided by the PLC device manufacturer documentation.
- Shut off the power supply of the PLC, before you install the ILX69-PBM module.

2.4.2 Device Destruction by Exceeding Allowed Supply Voltage

To avoid device destruction due to high supply voltage to the ILX69-PBM, you must observe the following instructions.

- The ILX69-PBM may only be operated with the specified supply voltage. Make sure that the limits of the allowed range for the supply voltage are not exceeded.
- A supply voltage above the upper limit can cause severe damage to the ILX69-PBM.
- A supply voltage below the lower limit can cause malfunction in the ILX69-PBM.
- The allowed range for the supply voltage is defined by the tolerances specified in this manual.



Mandatory supply voltage information is located at Power Supply (page 20).

2.4.3 Device Destruction by Exceeding Allowed Signaling Voltage

To avoid device destruction due to high signal voltage to the ILX69-PBM, you must observe the following instructions.

- All I/O signal pins at the ILX69-PBM tolerate only the specified signaling voltage.
- Operation of the ILX69-PBM with a signaling voltage other than the specified signaling voltage may lead to severe damage to the module.



Mandatory signaling voltage information is located at Power Supply (page 20).

2.4.4 Electrostatically sensitive devices







This equipment is sensitive to electrostatic discharge, which can cause internal damage and affect normal operation. Therefore, adhere to the necessary safety precautions for components that are vulnerable with electrostatic discharge when handling the ILX69-PBM. Follow the guidelines listed when you handle this equipment:



- Touch a grounded object to discharge potential static.
- Wear an approved grounding wrist strap.
- Do not touch connectors or pins on the ILX69-PBM.
- Do not touch circuit components inside the equipment.
- If available, use a static-safe workstation.
- When not in use, store the equipment in appropriate static-safe packaging.

More information is located at Safety References (page 15).

2.5 Labeling of Safety Messages

- The **Safety Messages** at the beginning of a chapter are pinpointed particularly and highlighted by a signal word according to the degree of endangerment. The type of danger is specified by the safety message text and optionally by a specific safety sign.
- The **Integrated Safety Messages** within an instruction description are highlighted with a signal word according to the degree of endangerment. The type of danger is specified by the safety message text.

Signal Word	Meaning (International)		Meaning (USA)
	Indicates a direct hazard with high risk, which will have a consequence of death or grievous bodily harm if it is not avoided.		Indicates a hazardous situation which if not avoided, will result in death or serious injury.
	Indicates a possible hazard with medium risk, which will have a consequence of death or (grievous) bodily harm if it is not avoided.		Indicates a hazardous situation which if not avoided, could result in death or serious injury.
	Indicates a minor hazard with medium risk, which could have a consequence of simple battery if it is not avoided.		Indicates a hazardous situation which if not avoided, may result in minor or moderate injury.
Safety Sign	USA	Warning or Principle	
		Warning of lethal electrical shock	
		Principle: Disconnect the power plug	

Signal Word	Meaning (International and USA)	
	Indicates a property damage message.	
Safety Sign	Warning or Principle	
	Warning on damages by electrostatic discharge	
-	Example: Warning of device destruction due to exceedingly high supply voltage	

In this document, all Safety Instructions and Safety Messages are designed according both to the international used safety conventions as well as to the ANSI Z535.6 standard, refer to Safety References (page 15).

In this document, the signal words 'WARNING', 'CAUTION' and 'NOTICE' are used according to ANSI Z535.6 standard. The meaning given in ISO/IEC 26514 [4] section '11.11 Contents of warnings and cautions is not relevant in this manual.

2.6 Safety References

- [S1] ANSI Z535.6-2006 American National Standard for Product Safety Information in Product Manuals, Instructions, and Other Collateral Materials
- [S2] IEC 60950-1, Information technology equipment - Safety - Part 1: General requirements, (IEC 60950-1:2005, modified); German Edition EN 60950-1:2006
- [S3] EN 61340-5-1 and EN 61340-5-2 as well as IEC 61340-5-1 and IEC 61340-5-2
- [S4] 26514-2010 - IEEE Standard for Adoption of ISO/IEC 26514:2008 Systems and Software Engineering--Requirements for Designers and Developers of User Documentation

3 About the ILX69-PBM

3.1 Device Drawing

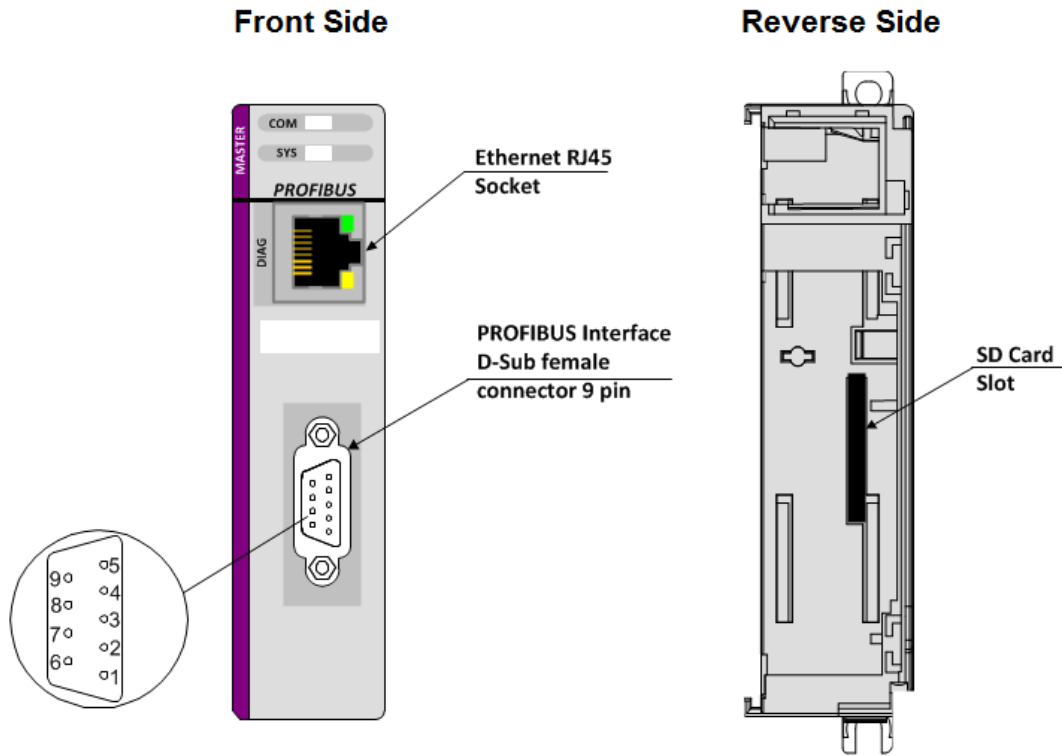

3.2 PROFIBUS Interface

PROFIBUS Interface (D-Sub female connector, 9 pin):

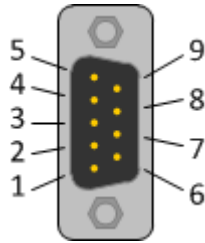

Connection with D-Sub female connector	Signal	Description
3	RxD / TxD-P	Receive/Send Data-P, respectively connection B plug
4	CNTR-P	Repeater-Control
5	DGND	Data Ground
6	VP	Positive supply voltage
8	RxD / TxD-N	Receive/Send Data-N, respectively connection A plug

3.2.1 Wiring Instructions

Please ensure that termination resistors are available at both ends of the PROFIBUS network cable. If special PROFIBUS connectors are being used, these resistors are often found inside the connector and must be switched on at each end of the PROFIBUS network cable.

For baud rates above 1.5 MBaud, use only special connectors for higher baud rates. These include additional inductance.

It is not permitted to have T-stubs on PROFIBUS high baud rates. Use only a special cable which is approved for PROFIBUS DP. Make a solid connection from the cable shield to ground at every device and make sure that there is no potential difference between the grounds at the devices.

If the ILX69-PBM is linked with only one other device on the bus, both devices must be connected to the ends of the bus line. These devices must deliver the supply voltage for the termination resistors. If three or more devices are connected to the bus, the ILX69-PBM can be connected at any desired position.

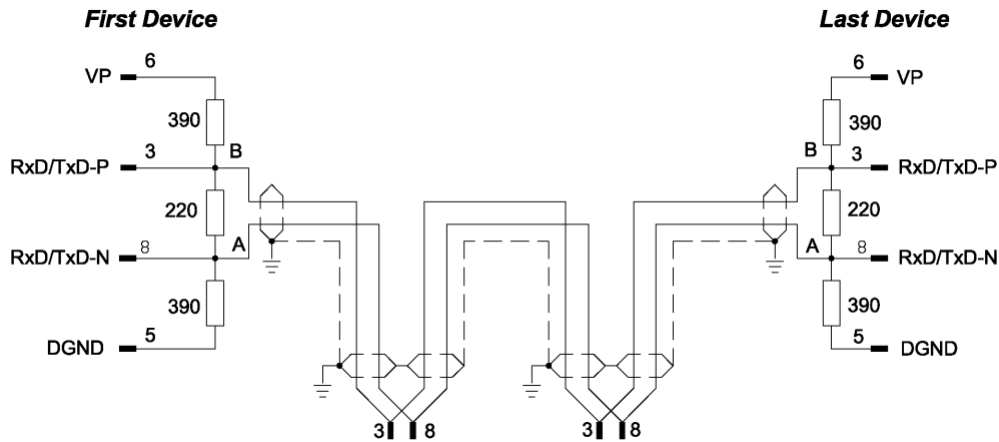

Up to 32 PROFIBUS devices can be connected to one bus segment, without repeaters. If several bus segments are linked to each other with repeaters, there can be up to 127 devices on the network.

The maximum permissible cable length of a PROFIBUS segment depends on the baud rate used, see the following table:

Baud rate in kBit/s	Maximum distance
9.6	1,200 meters 3,940 feet
19.2	1,200 m 3,940 ft
93.75	1,200 m 3,940 ft
187.5	1,000 m 3,280 ft
500	400 m 1,310 ft
1,500	200 m 656 ft
3,000	100 m 328 ft
6,000	100 m 328 ft
12,000	100 m 328 ft

Only PROFIBUS certified cables, preferably the cable type A, should be used. The following table contains important electrical data concerning PROFIBUS certified cable:

Parameter	Value
Impedance	35 to 165 Ohm at frequencies from 3 to 20 Mhz
Capacity per units length	< 30 pF/m
Loop resistance	110 Ohm/km
Wire gauge	0.64 mm

3.3 Ethernet Interface

The Ethernet cable should contain an RJ45 connector. It should have a twisted pair cable of category 5 (CAT5) or higher, which consists of 4 twisted cores and has a maximum transmission rate of 100 MBit/s (CAT5).

3.3.1 Ethernet Pin Assignment at the RJ45 Socket



Note: The device supports the **Auto Crossover** function. The RX and TX can be switched. The following figure shows the RJ45 standard pin assignment.

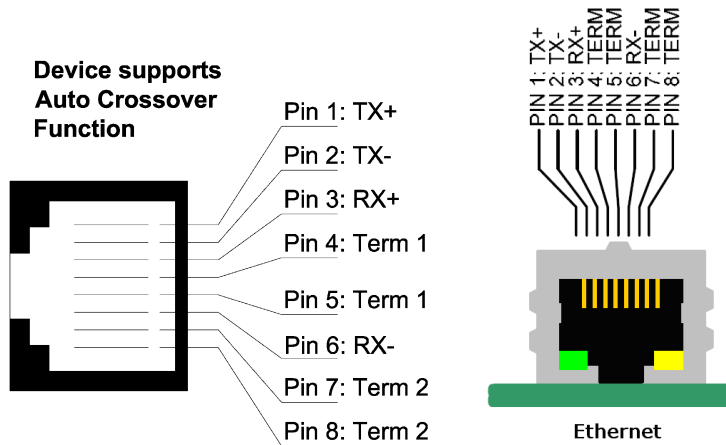

Pin	Signal	Description
1	TX+	Transmit Data +
2	TX-	Transmit Data -
3	RX+	Receive Data +
4	Term 1	Connected to each other and terminated to PE through RC circuit*
5	Term 1	
6	RX-	Receive Data -
7	Term 2	Connected to each other and terminated to PE through RC circuit*
8	Term 2	
		*Bob Smith Termination

3.3.2 Ethernet Connection Data

Medium	2 x 2 Twisted-pair copper cable, CAT5 (100 MBit/s) or better
Length of cable	Maximum 100 m
Transmission rate	10 MBit/s / 100 MBit/s

3.4 Removable Memory Card

Memory Card

Type	SD card (HDSC format is not supported)
Maximum storage capacity	4 GByte
Required formatting	FAT16 format (no FAT32)

SD Card Connector

SD Card Connector, e.g. FPS009-2405-0 push/push

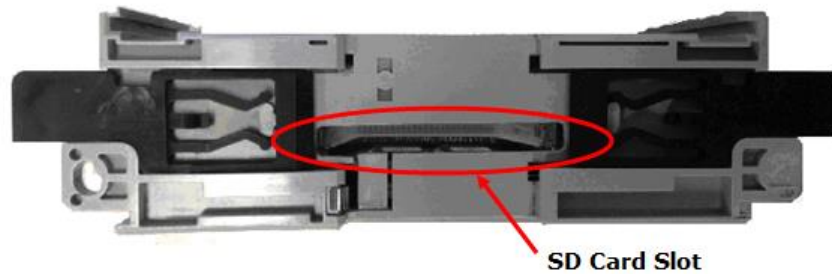

3.5 Power Supply

Power supply	5V from backplane
Current Load CompactLogix	570 mA Max. @ 5 VDC Power rating of 2
Backplane power	5 VDC: Min: 4.75 V at Module; Max: 5.40 V at Module 24 VDC: Min: 19.9 V at Module; Max: 26.4 V at Module

4 Installation

4.1 System Planning Considerations

Network Conception

- The ILX69-PBM can communicate with up to 125 PROFIBUS slave devices.
- A 1769-ECR (right end cap) or 1769-ECL (left end cap) is required to terminate the end of the Compact I/O bus.
- Each bank of CompactLogix I/O must have its own power supply.
- A CompactLogix I/O power supply has limits of +5V to +24V DC. These limits depend on the catalog number (e.g. 1769-PA2) of the power supply. A bank of modules must not exceed the current limits of the I/O bank power supply. Refer to the Compact 1769 Expansion I/O Power Supplies Installation Instructions.
- The ILX69-PBM has a distance rating of 2. Therefore, the module must be within 2 slots of the I/O bank's power supply.

Configuration and Network Communication

- Determine the PROFIBUS baud rate based on standard PROFIBUS system considerations.
- Identify the number of words of I/O data each slave supports.

4.2 Software Installation

4.2.1 Installing ProSoft fdt Configuration Manager in Windows 7



Note:

- When **ProSoft fdt Configuration Manager** is installed on a PC, Hilscher standard SYCON.net as well as legacy PROSOFT.fdt cannot be and shall not be installed, and vice-versa.
- You need administrator privileges under Windows® 7 to install the configuration software **ProSoft fdt Configuration Manager** on your PC.

- 1 Please visit www.prosoft-technology.com and download the *ProSoft fdt Configuration Manager setup.exe* file from the ILX69-PBM webpage.
- 2 Double-click the *ProSoft fdt Configuration Manager setup.exe*.

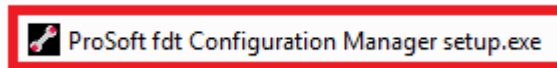

- 3 Select **Yes** at the Windows® security question.
- 4 Alternatively, you can reduce the number of Windows® safety questions by running the setup via **Run as Administrator**. Right-click on the ProSoft fdt Configuration Manager.exe file and click **Run as Administrator** and answer the Windows® security question with **Yes**.

The **ProSoft fdt Configuration Manager** pane is displayed.

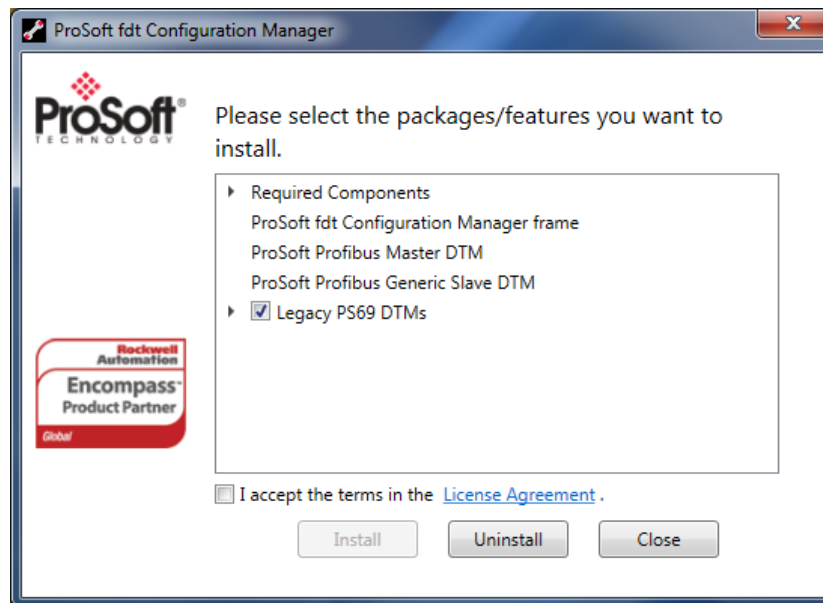

- 5 If required, select **Legacy PS69 DTMs** if the PC running the new version of PROSOFT.fdt Configuration Manager is also going to be used to configure legacy ProSoft PS69-DPM modules.
- 6 When ready, select the **I accept the terms in the License Agreement** box.

7 Click **Install** to continue the installation.

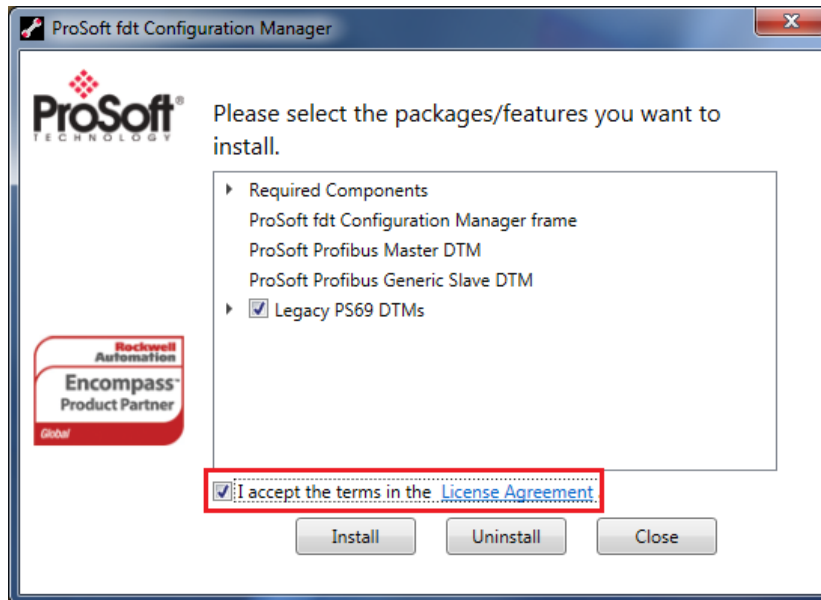

The installation will take several minutes.

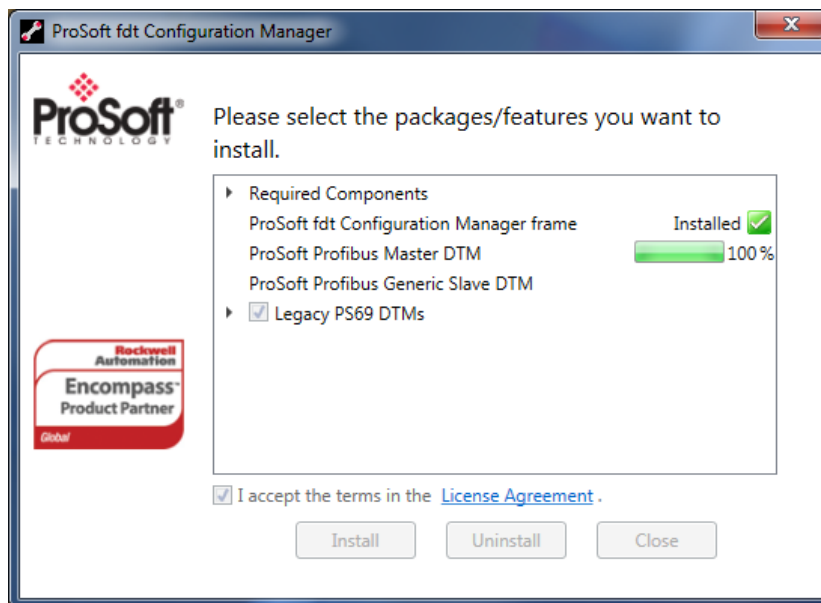

8 Click **Close** when installation is complete.

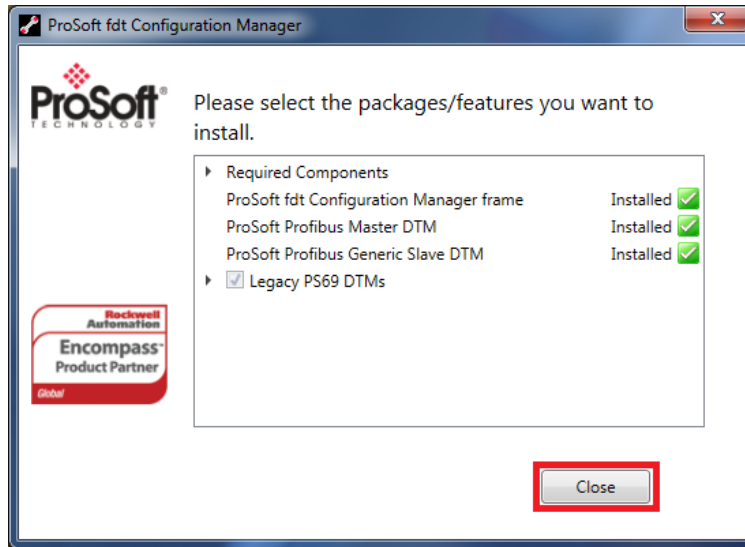

The **ProSoft fdt Configuration Manager** is now installed. It can be launched from the Windows Start menu.

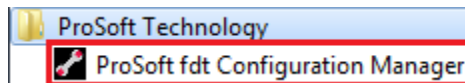

4.3 ILX69-PBM Hardware Installation

This section describes how to install/uninstall the ILX69-PBM in a CompactLogix™ system.

4.3.1 Safety Precautions

Obey the following property damage messages when installing, uninstalling or replacing the ILX69-PBM.

NOTICE

Electrostatically sensitive devices

- To prevent damage to the PLC and the ILX69-PBM, make sure that the ILX69-PBM is grounded via the backplane of the PLC. Also make sure you are discharged when you install/uninstall the ILX69-PBM.

NOTICE

Device Destruction

- Shut off the power supply of the PLC before you install the ILX69-PBM. Then install or remove the ILX69-PBM to/from the PLC..
- Use only the permissible supply voltage to operate the ILX69-PBM.
- All I/O signal pins at the ILX69-PBM tolerate only the specified signaling voltage.

4.3.2 Installing the ILX69-PBM Module



A detailed description the installation of communication modules in CompactLogix™ systems can be found in the installation manual for the 1769 CompactLogix™ controller from Rockwell Automation.

- 1 Install the ILX69-PBM into a free slot in the CompactLogix™ controller. Make sure it is within 2 slots of a power supply.
- 2 Check that the bus lever of the ILX69-PBM is in the unlocked (fully right) position.
- 3 Assemble the ILX69-PBM and the CompactLogix™ module together by using the upper and lower tongue-and-groove slots.
- 4 Move the ILX69-PBM back along the tongue-and-groove slots until the bus connectors line up with each other.
- 5 Move the ILX69-PBM bus lever fully to the left until it clicks. Ensure it is locked firmly in place.
- 6 Attach and lock an end cap terminator to the ILX69-PBM by using the tongue-and-groove slots as before.
- 7 Apply power to the Rockwell CompactLogix™ controller.

4.4 Uninstalling ILX69-PBM Hardware

- 1 Adhere to the safety precautions.
- 2 Shut off the power of the Rockwell CompactLogix™ controller.
- 3 Discharge yourself.
- 4 Unlock the end cap bus terminator.
- 5 Remove the end cap terminator from the ILX69-PBM by using the tongue-and-groove slots.
- 6 Move the ILX69-PBM bus lever in the unlocked (fully right) position.
- 7 Remove the ILX69-PBM along the tongue-and-groove slots.
- 8 Reassemble the end cap terminator and the CompactLogix™ system together by using the upper and lower tongue-and-groove slots.

5 Configuration and Start-Up

This chapter provides descriptions about the configuration and start-up of the ILX69-PBM.

ILX69-PBM Configuration and Parameterization Steps:

The configuration and parameterization of the ILX69-PBM is carried out in three steps:

- 1 Configuration of the module in a CompactLogix™ project using the Studio 5000 or RSLogix 5000 programming tool.
- 2 Parameterization and configuration of the ILX69-PBM with the ProSoft fdt Configuration Manager configuration software.
- 3 Creating the data objects and the ladder diagram in Studio 5000/RSLogix 5000.

5.1 CompactLogix Project

This section covers the configuration of the ILX69-PBM in a CompactLogix™ system.

5.1.1 Creating a New Project

- 1 Open the **FILE** menu, and select **NEW**.

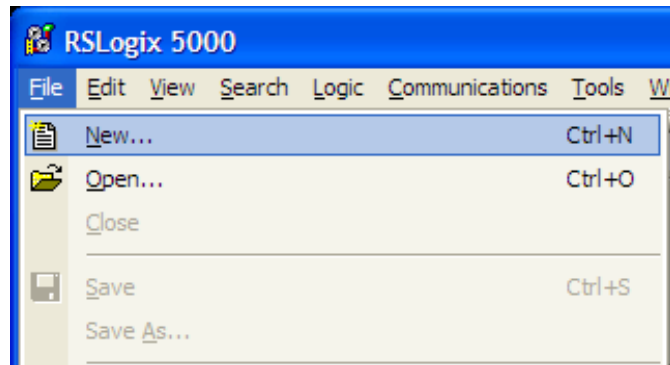

- 2 Select your controller **TYPE** and **REVISION** 16 or newer.

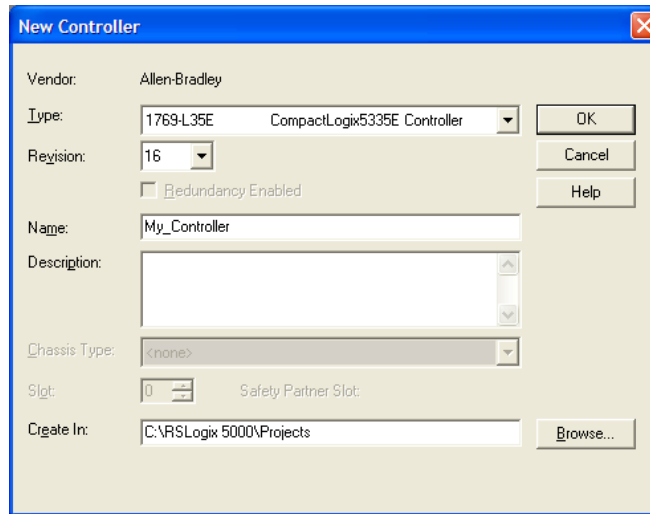

- 3 Click **OK**.
- 4 Right click on the **I/O configuration > CompactBus Local** of the controller project.
- 5 Select **New Module** from the context menu as shown below.

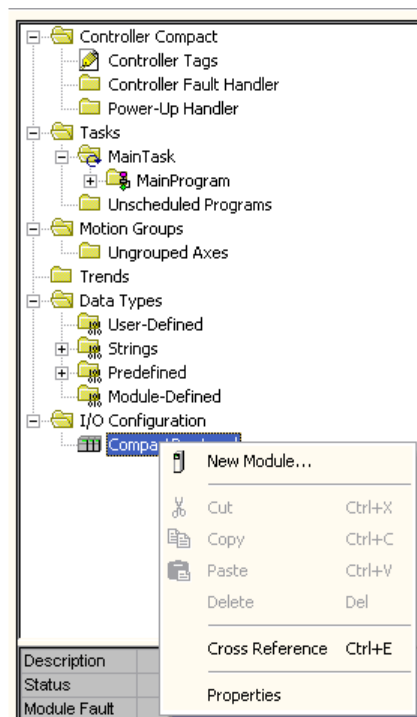

The following dialog box appears.

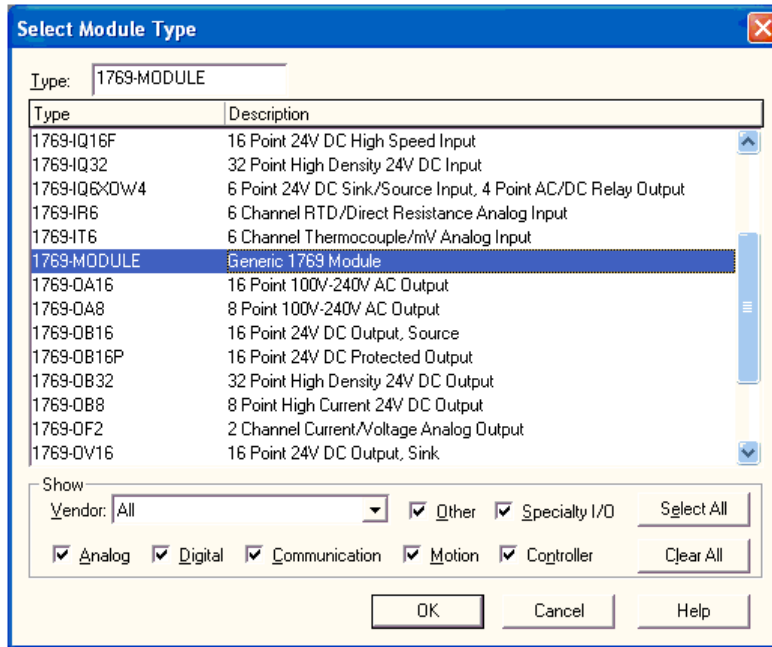

- 6 Select "**1769-MODULE Generic 1769 module**" and click **OK**. The *Module Properties* dialog will open.

5.1.2 Module Properties 1

- 1 The communications parameters for the module are configured in the *Module Properties* dialog.

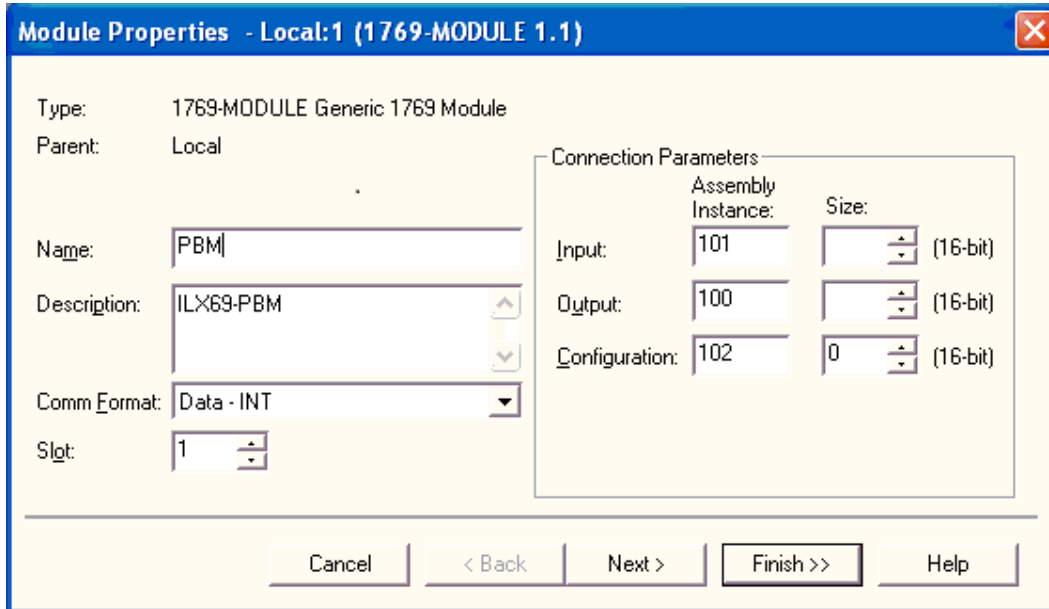

- 2 Enter **PBM** as the **NAME** and enter a short description for the module.
- 3 Select the **Slot** number in which the module is installed in the CompactLogix system. It must be within 2 slots of a power supply.
- 4 Select **Data - INT** as the **Comm_Format**.
- 5 Set the connection parameters as they are shown in the dialog. The *Connection Parameter SIZE(s)* may vary.

Connection Parameter	Assembly Instance	Size (in Words)
Input	101	44 + X (Where X = 0 to 204) = 248 max
Output	100	8 + Y (Where Y = 0 to 240) = 248 max
Configuration	102	0



Note: The **Size** parameters vary for each PROFIBUS network. You can customize these values using section Adjusting Input/Output Data Lengths in the Project 48.

X = Number of Words configured for the ILX69-PBM (PROFIBUS input data); input size can be in the range between 44 and 248 words

Y = Number of Words configured for the ILX69-PBM (PROFIBUS output data); output size can be in the range between 8 and 248 words

- Input Size – The input size must be at least 88 Bytes (44 Words). It must be large enough to accommodate the status information required by the module, which is 88 Bytes (44 Words) and the total number of PROFIBUS input data values from the slaves in the network. You can increase the size of this area using the size of each Input module connected. The Input image starts with byte 88.
- Output Size – The output size must be at least 16 Bytes (8 Words). It must be large enough to accommodate the command information required by the module, which is 16 bytes (8 Words), and the total number of PROFIBUS output data values to the slaves in the network. You can increase the size of this area using the size of each Output module connected. The Output image starts with byte 16.

6 Select **Next >>** or **OK** for the next configuration dialog.

5.1.3 Module Properties 2

The Requested Packet Interval RPI is shown in the following dialog. Within this time interval, the I/O data between module and controller are exchanged.

1 Edit the **REQUESTED PACKET INTERVAL (RPI)** value, if needed.

It is not possible to change the RPI in this dialog separately for each module. The RPI can be changed in the properties dialog of the "CompactBus Local" for all I/O modules.

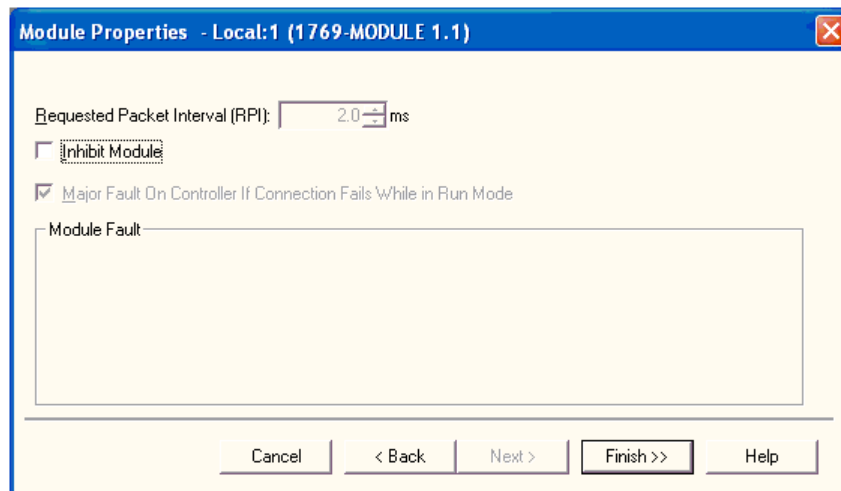

- 2 Click **Finish>>**
- 3 Save the project.

5.1.4 Importing the Ladder Rung

- 1 In the *Controller Organization* window, expand the **TASKS** folder and subfolder until you reach the **MAINPROGRAM** folder.
- 2 In the **MAINPROGRAM** folder, double-click to open the **MAINROUTINE** ladder.
- 3 Select an empty rung in the new routine, and then click the right mouse button to open a shortcut menu. On the shortcut menu, choose **IMPORT RUNGS**.

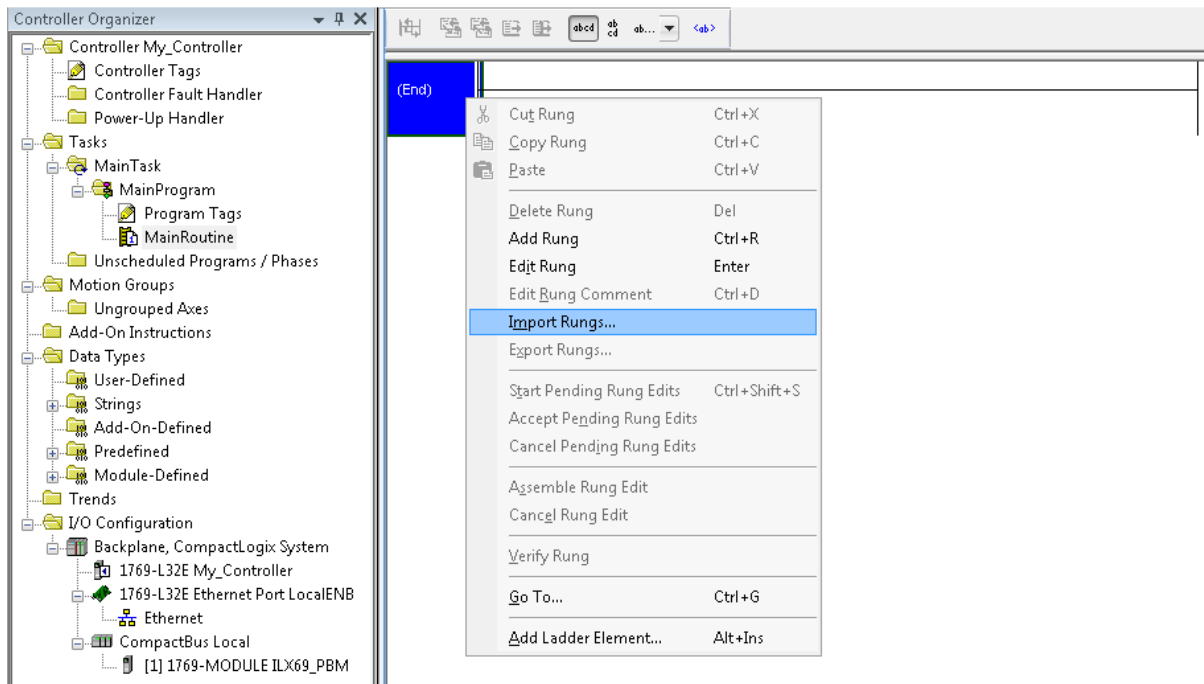

- Navigate to the location on your PC where the **.L5X** Add-On Instruction (for example, *My Documents* or *Desktop*) is saved. Select **IMPORT...**

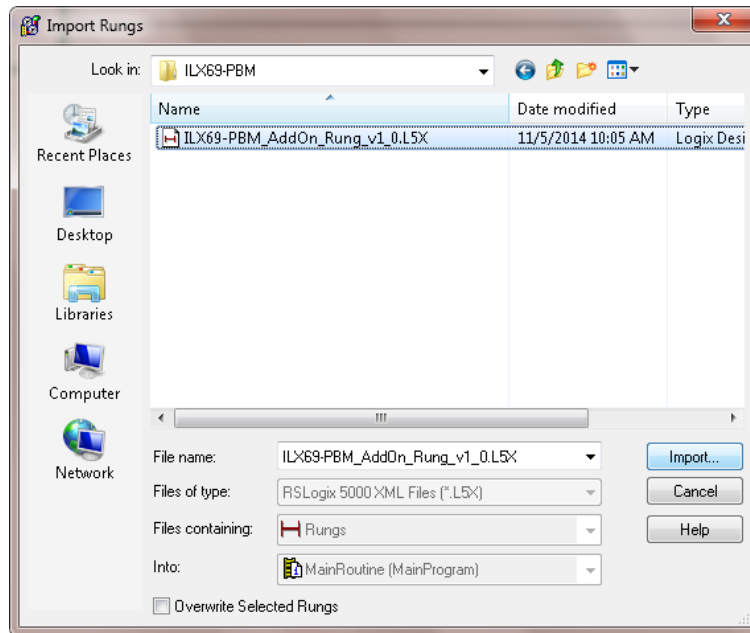

This action opens the *Import Configuration* dialog box, showing the controller tags that will be created.

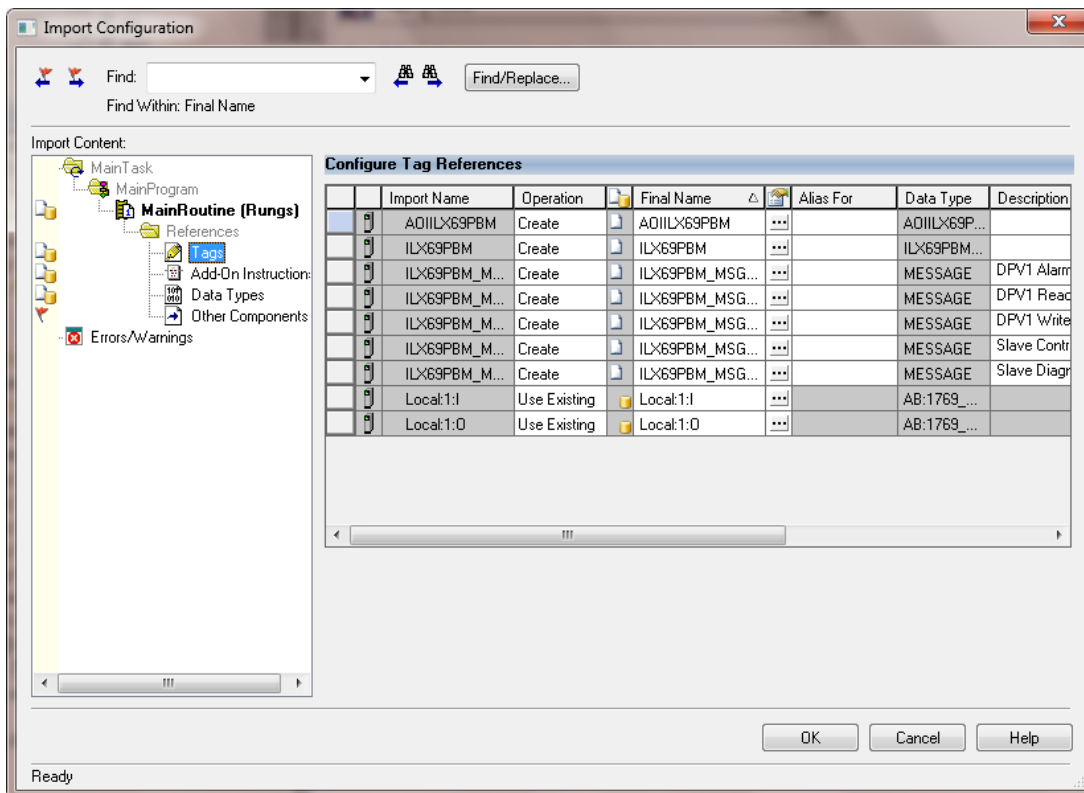

5 Verify that the slot number is correct for the module in the *Local:x* tags.

	Import Name	Operation	Final Name	Alias For	Data Type	Description
	AOILX69PBM	Create	AOILX69PBM	...	AOILX69P...	
	ILX69PBM	Create	ILX69PBM	...	ILX69PBM...	
	ILX69PBM_M...	Create	ILX69PBM_MSG...	...	MESSAGE	DPV1 Alarm
	ILX69PBM_M...	Create	ILX69PBM_MSG...	...	MESSAGE	DPV1 Read
	ILX69PBM_M...	Create	ILX69PBM_MSG...	...	MESSAGE	DPV1 Write
	ILX69PBM_M...	Create	ILX69PBM_MSG...	...	MESSAGE	Slave Contr
	ILX69PBM_M...	Create	ILX69PBM_MSG...	...	MESSAGE	Slave Diagn
	Local:1:I	Use Existing	Local:1:I	...	AB:1769_...	
	Local:1:O	Use Existing	Local:1:O	...	AB:1769_...	

6 Click **OK** to confirm the import.

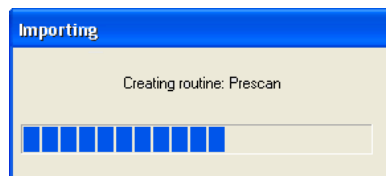

When the import is completed, the new Add-On Instruction rung will appear in the ladder.

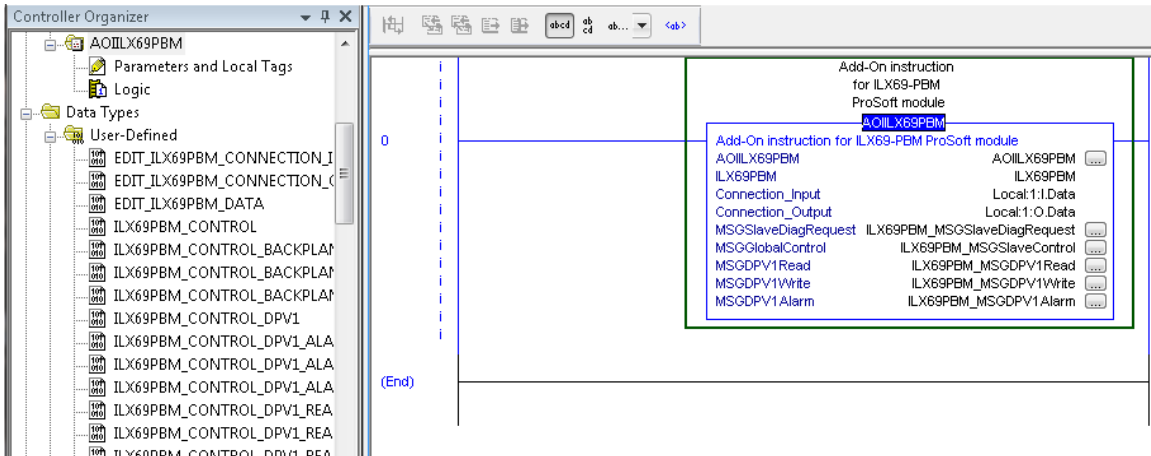

The procedure has also imported new user-defined data types, controller tags and the Add-On instruction for your project.



7 Save the project.

5.2 ProSoft fdt Configuration Manager

This section details the basics of using the ProSoft fdt Configuration Manager software to configure the ILX69-PBM and Slave I/O system. The configuration is downloaded via Ethernet to the module and stored into the Flash memory of the ILX69-PBM.

5.2.1 Creating a New ILX69-PBM Project

- 1 Launch the **ProSoft fdt Configuration Manager** from the *Windows Start* menu.

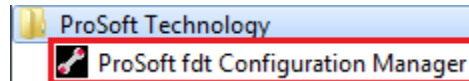

- 2 At the *User Login* dialog, use the following:

USER ROLE: Administrator
PASSWORD: (blank)

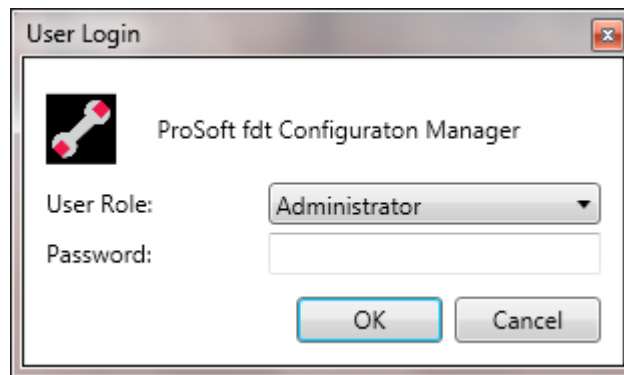

- 3 Click **OK** to open the ProSoft fdt Configuration Manager project window.
- 4 Create a new PROFIBUS project by selecting the **HOME** tab and clicking **NEW**. The *New Project* dialog opens.

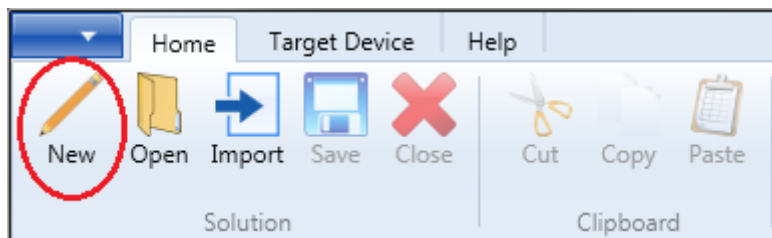

5 If needed, edit the **NAME**, **LOCATION**, and **SOLUTION NAME**. Then click **OK**.

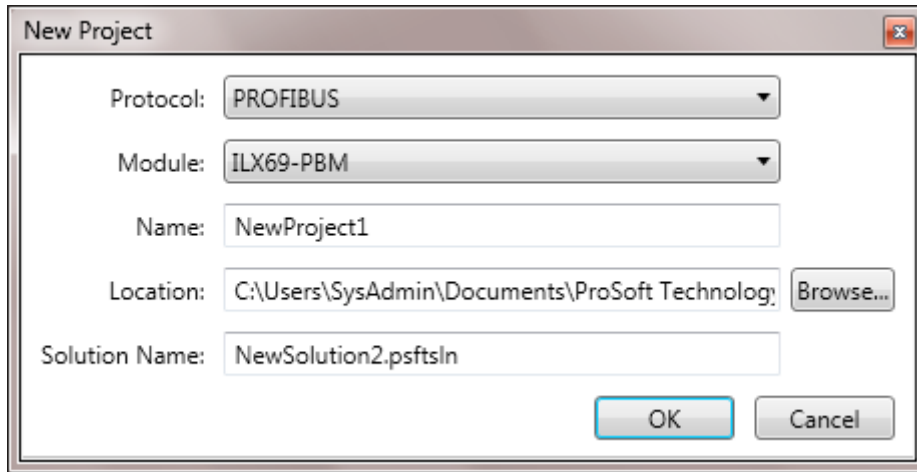

6 The ILX69-PBM Network bus is displayed.

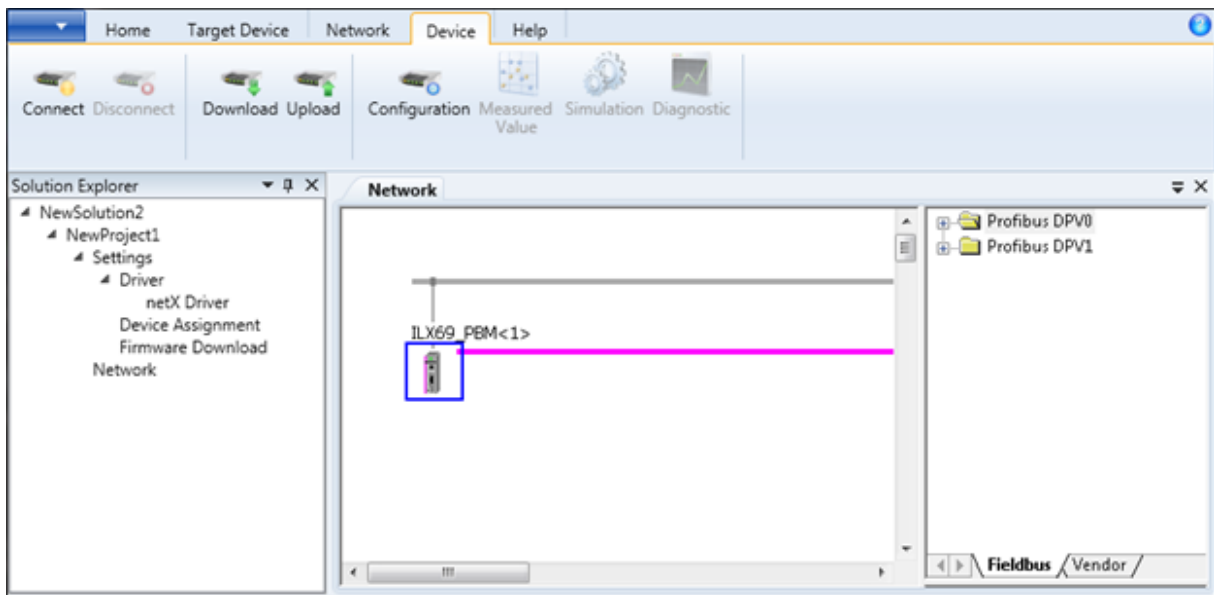

5.2.2 PROFIBUS Master Configuration

- 1 Double-click on the **ILX69_PBM** icon that appears in the *Network View*. In the navigation area on the left side of the *Configuration* dialog box, select **BUS PARAMETERS**.

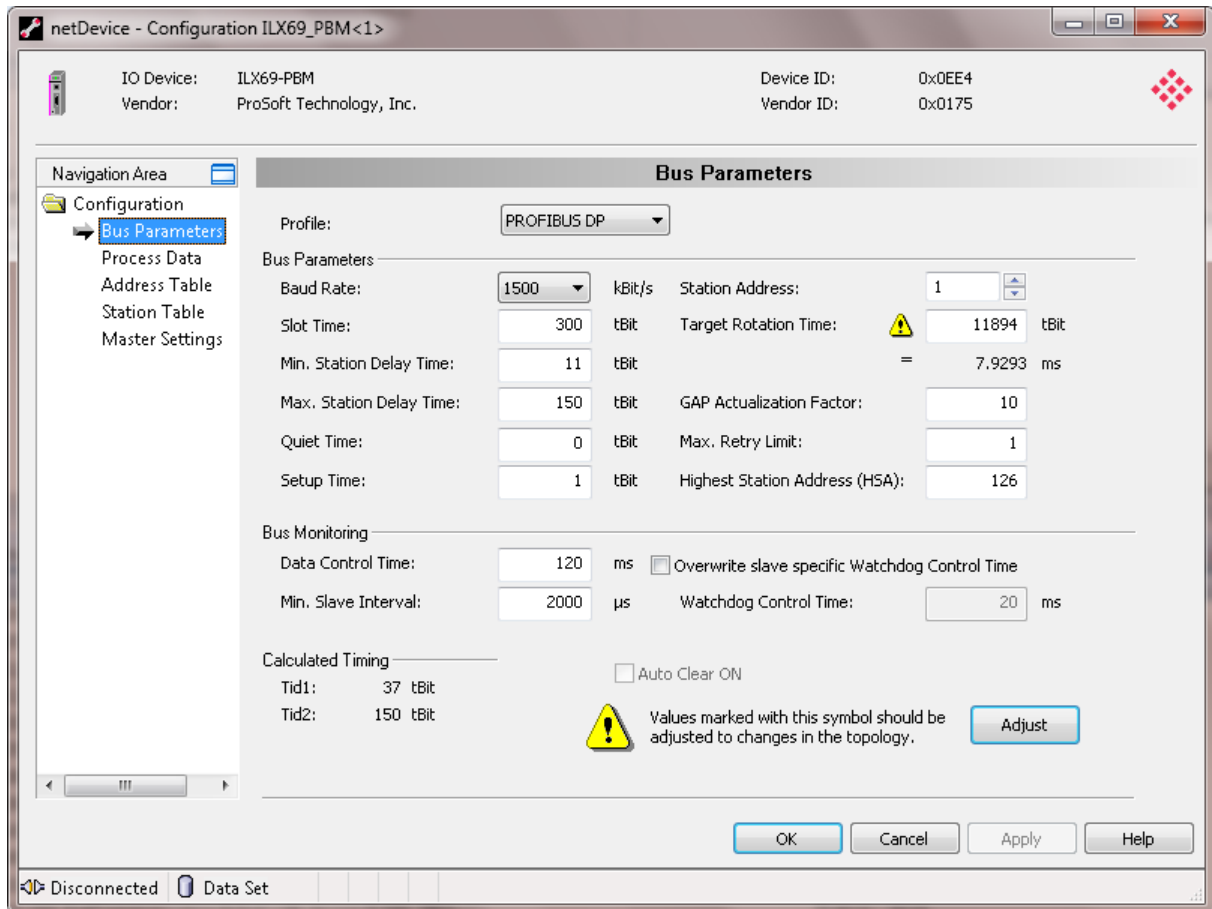

- 2 Select the **BAUD RATE** and **STATION ADDRESS** for the ILX69-PBM. The other parameters do not need adjustment. The default settings should be sufficient for most networks.
- 3 Click **OK**.

5.2.3 PROFIBUS Slave Configuration

The ProSoft fdt Configuration Manager comes pre-loaded with various PROFIBUS DPV0 and DPV1 slave GSD profiles. You can search them by **FIELDBUS** or **VENDOR** tabs at the bottom of the slave list pane.

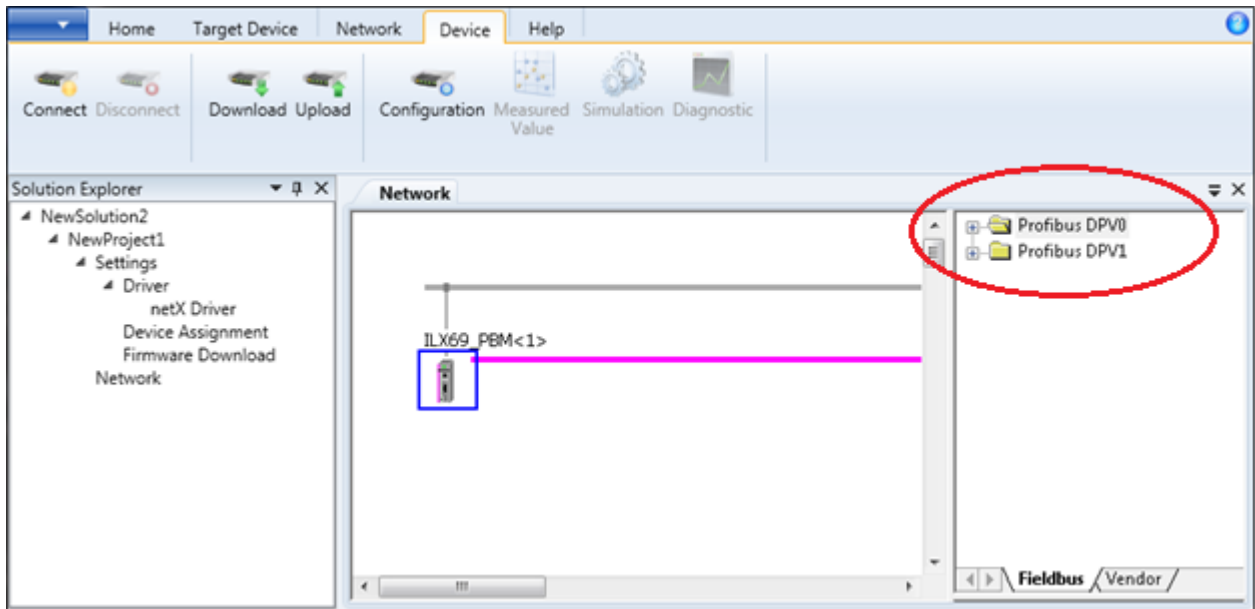

If you do not see your slave(s) listed, you will need to import them into the software.

Importing a slave profile into the ProSoft fdt Configuration Manager

Importing a slave to the ProSoft fdt Configuration Manager depends on the configuration method of the slave. It is done by importing the PROFIBUS GSD file (typical) or using the FDT/DTM technology.

Slave with DTM Technology

If the slave is configured by DTM technology, install the DTM software on your PC that was delivered with the slave. Then reload the Device Catalog in ProSoft fdt Configuration Manager.

Importing a GSD File

- 1 Select the **NETWORK** tab at the top of the project window and click on **IMPORT DEVICE DESCRIPTION**.

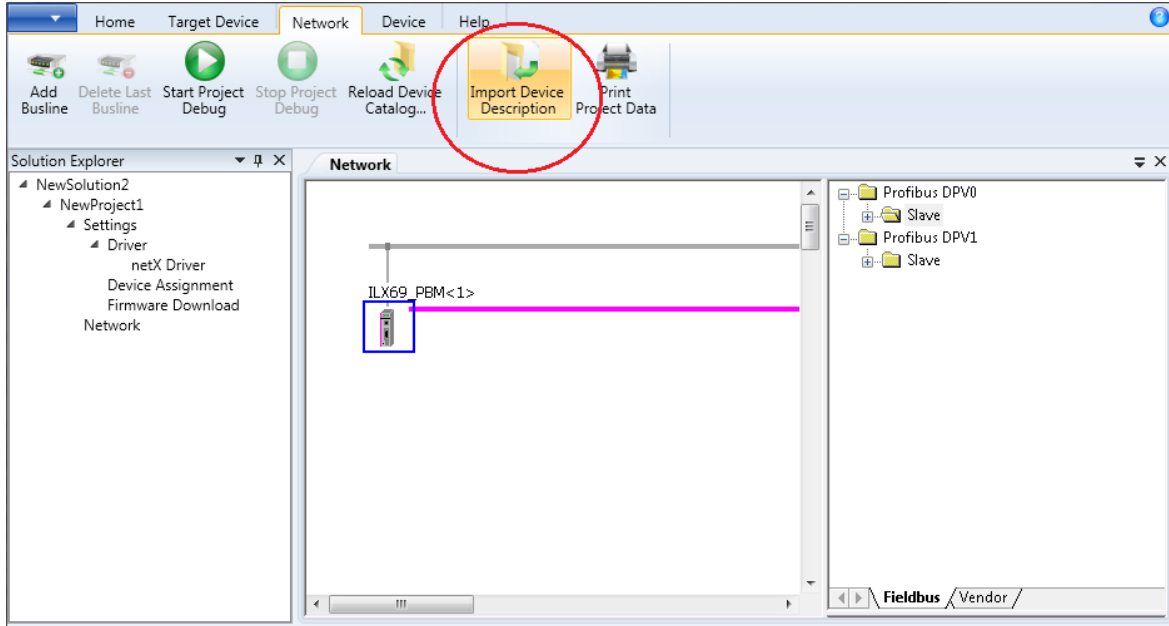

- 2 The *netDevice – Import Device Description* dialog opens. Navigate to the GSD file location on your PC and click **OPEN**.

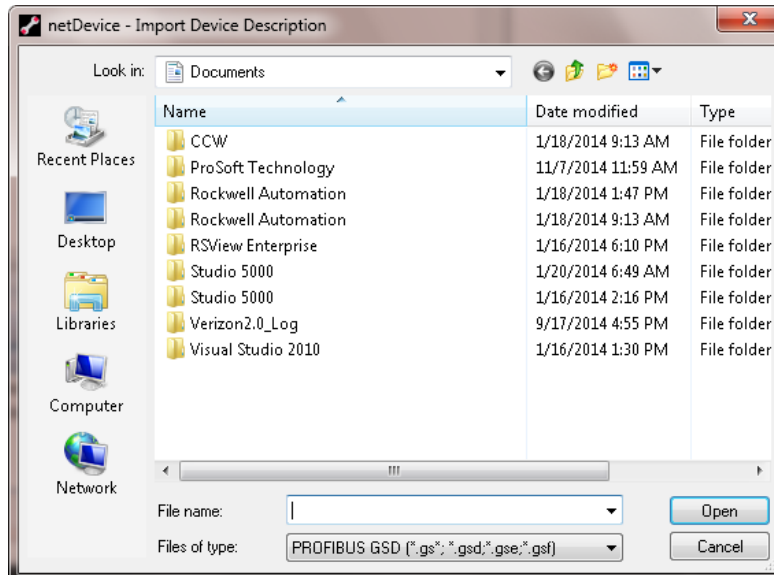

- 3 Follow the steps to import the GSD file. When prompted, select **YES** to *Reload Device Catalog*.
- 4 The slave is now listed in the device catalog.

Adding a Slave to the Project

- 1 In the ProSoft fdt Configuration Manager project screen, locate the slave in the slave catalog.

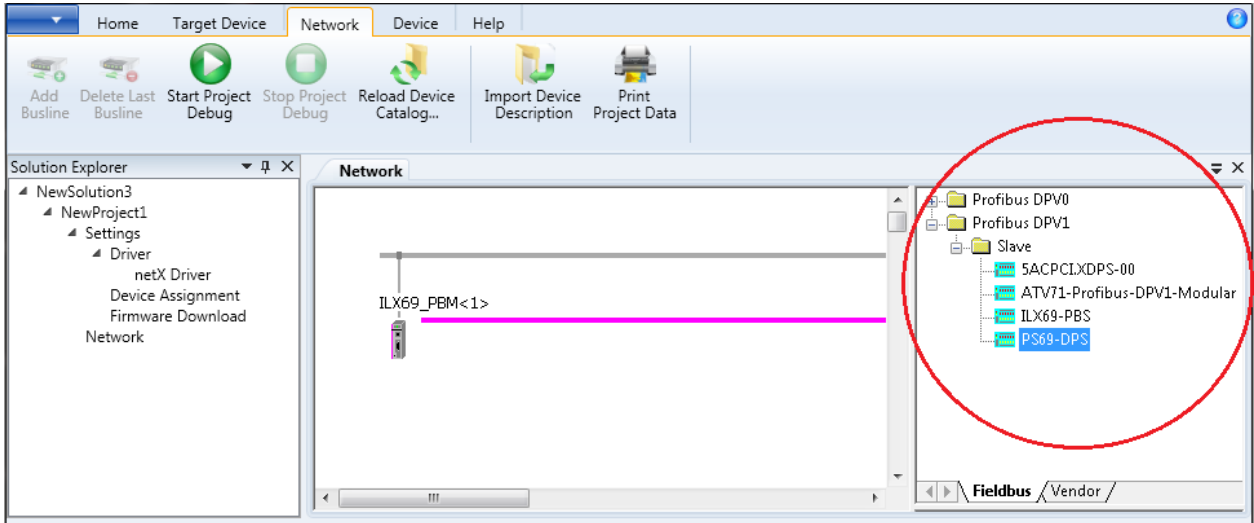

- 2 Drag and drop the slave onto the magenta PROFIBUS network line.

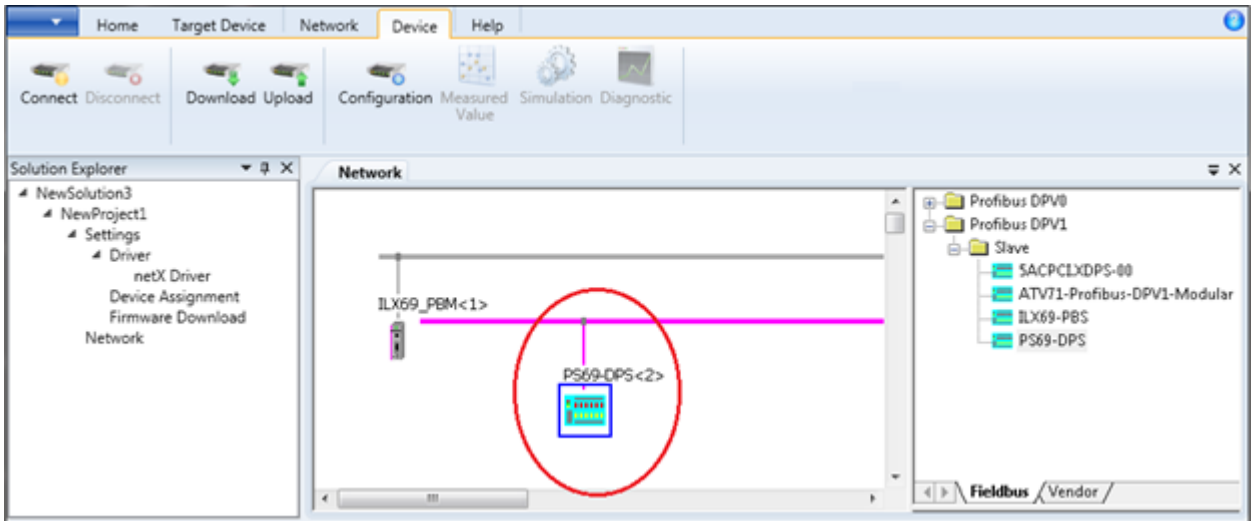

Slave Settings

- 1 Double-click on the slave icon in the *Network* view. A slave-specific configuration dialog box similar to the one shown below appears.

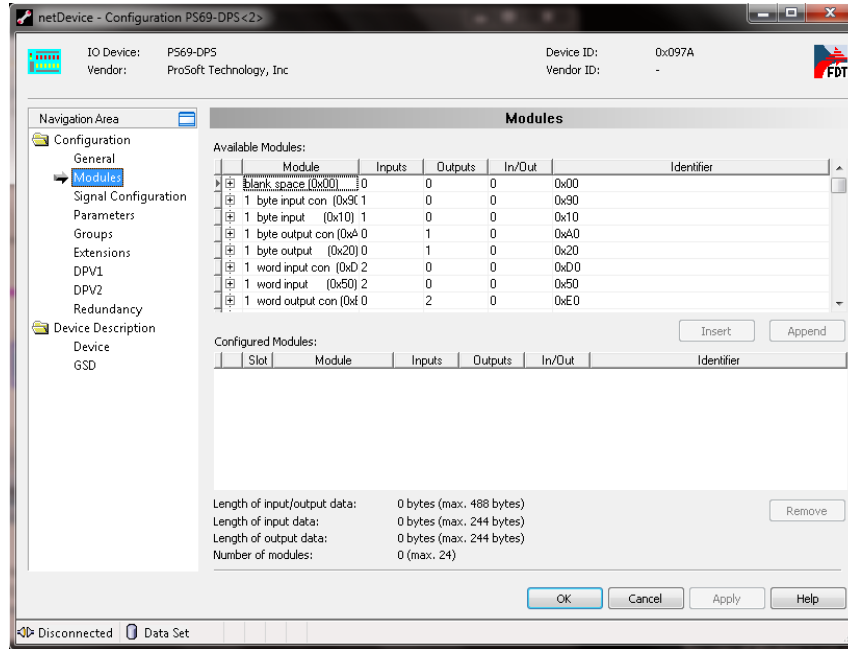

- 2 Under **CONFIGURATION > MODULES**, highlight and click **INSERT** on the appropriate inputs and outputs you will use for the slave.

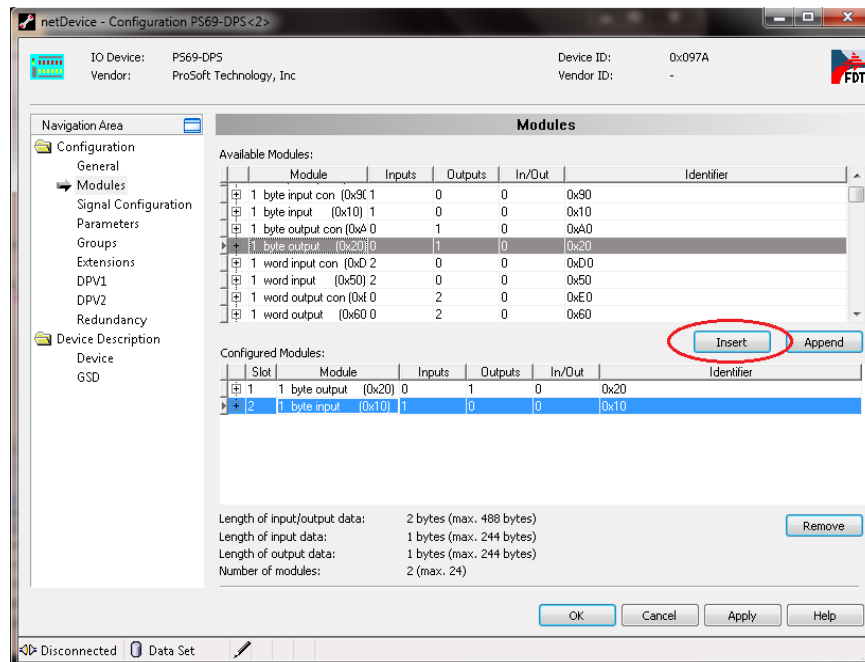

- 3 Click **APPLY** and then **OK**.

Editing the Slave Address

Assigning and editing a slave address is done in the ILX69-PBM configuration window.

- 1 Double-click on the **ILX69_PBM** icon in the *Network* pane.

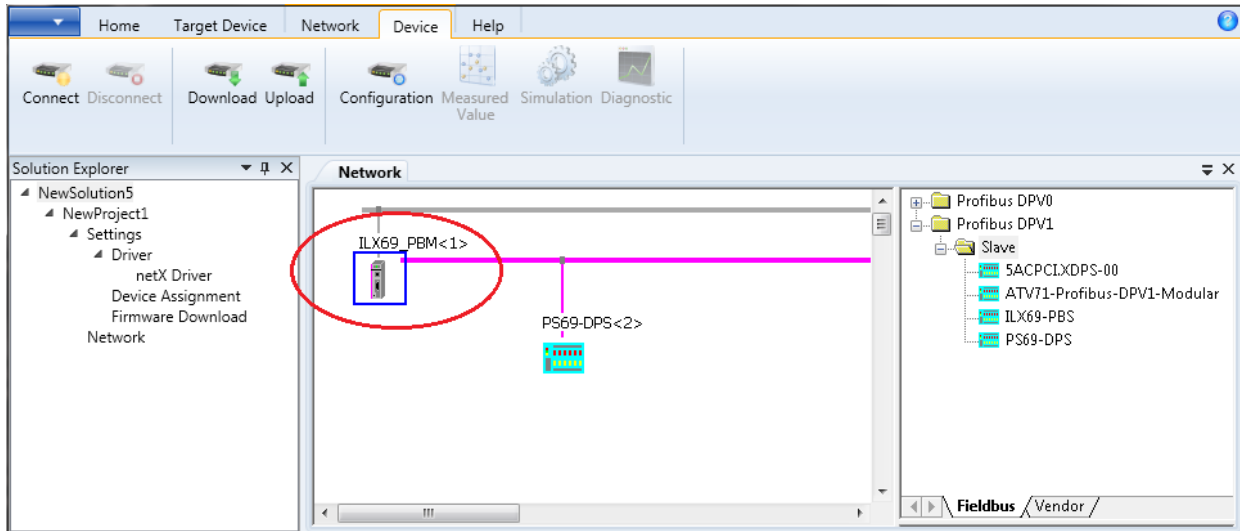

- 2 This opens the *netDevice – Configuration ILX69_PBM<x>* window.
- 3 In the **CONFIGURATION > STATION TABLE** selection, edit the slave's address under the *Station Address* parameter.

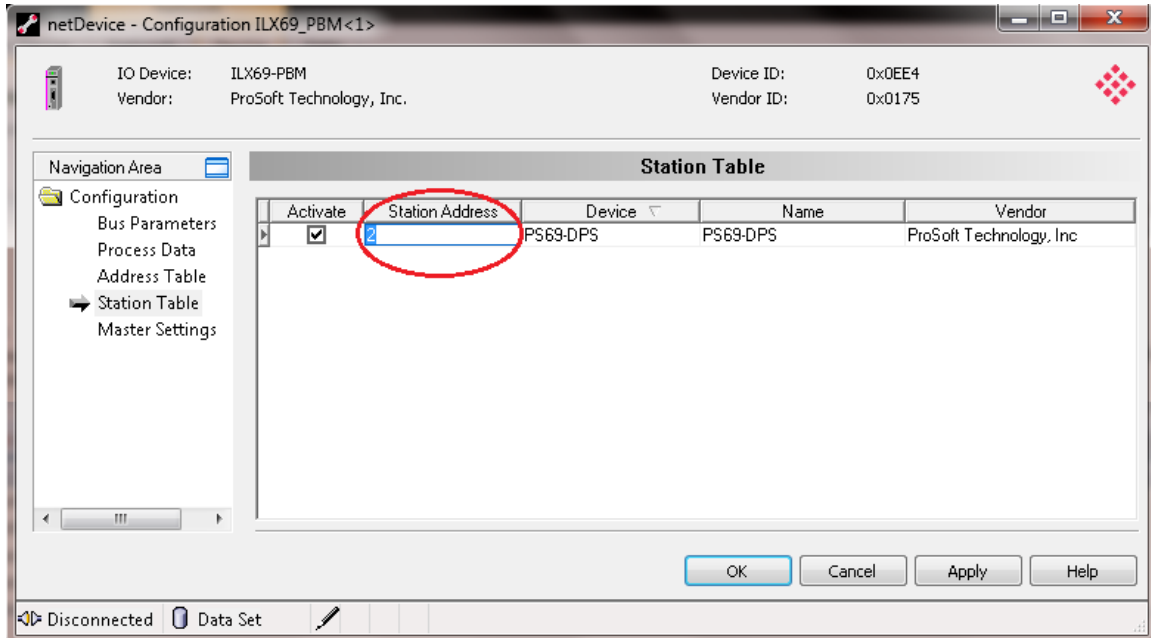

- 4 When complete, click **APPLY**, then **OK**.
- 5 Save the project.

5.3 Downloading the Project to the ILX69-PBM

Once saved, the project is now ready to be downloaded to the ILX69-PBM. Make sure the ILX69-PBM is connected to the same Ethernet network as your PC.

5.3.1 Assigning an IP Address

- 1 Select the **TARGET DEVICE** tab at the top of the project window and click on **IP SETTINGS**.

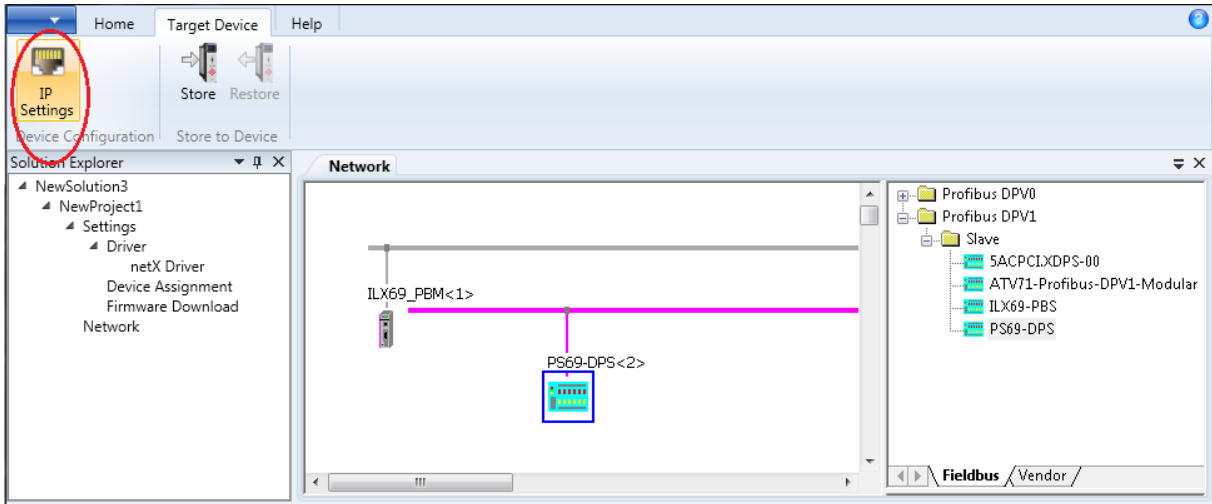

- 2 The software will automatically scan for the ILX69-PBM on the network.

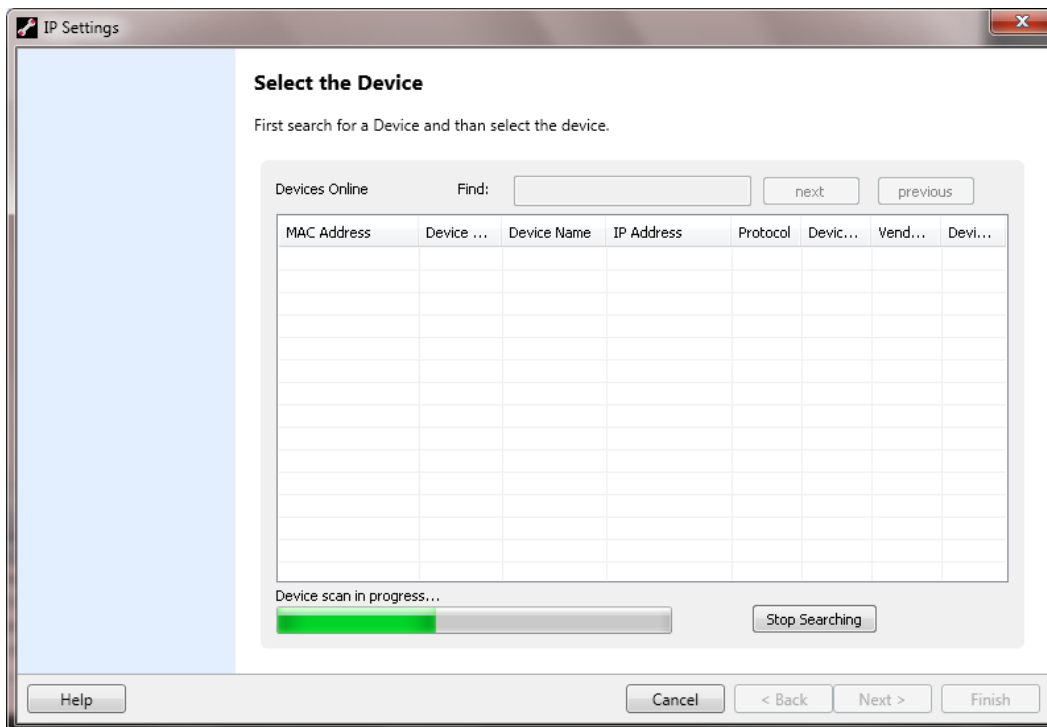

- 3 Once found, the ILX69-PBM information appears in the *Select the Device* dialog. Click **NEXT >**.

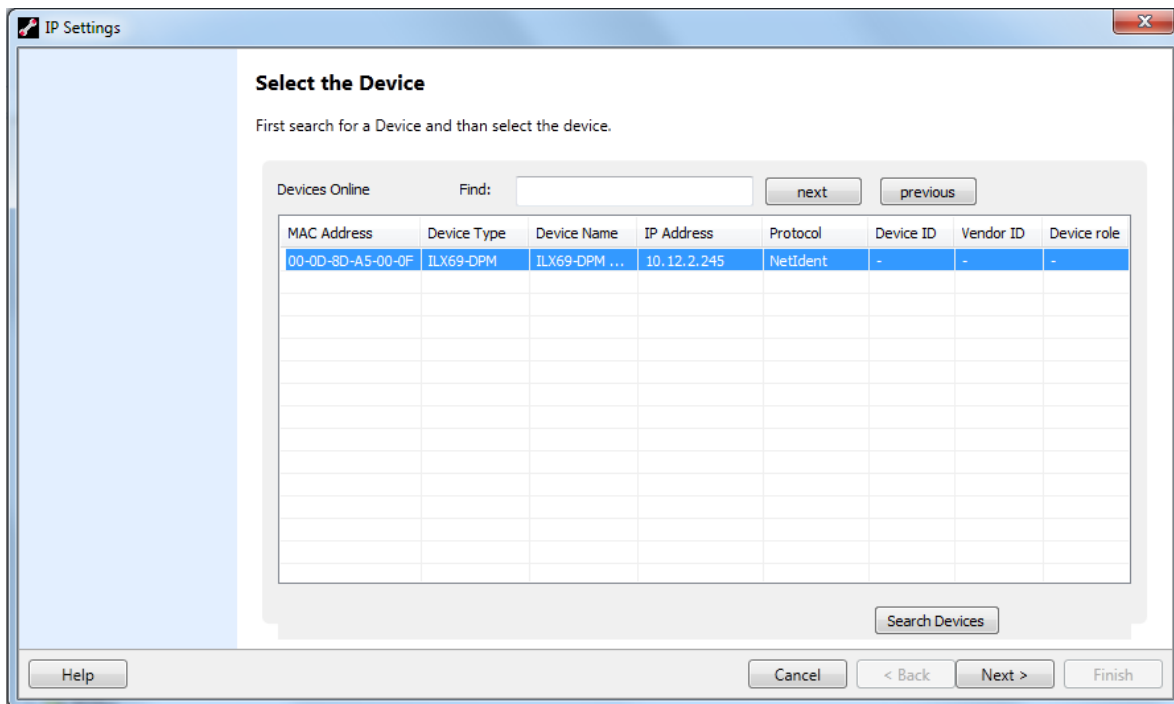

- 4 Assign the IP address of the ILX69-PBM in the *Set the Network Address* dialog.

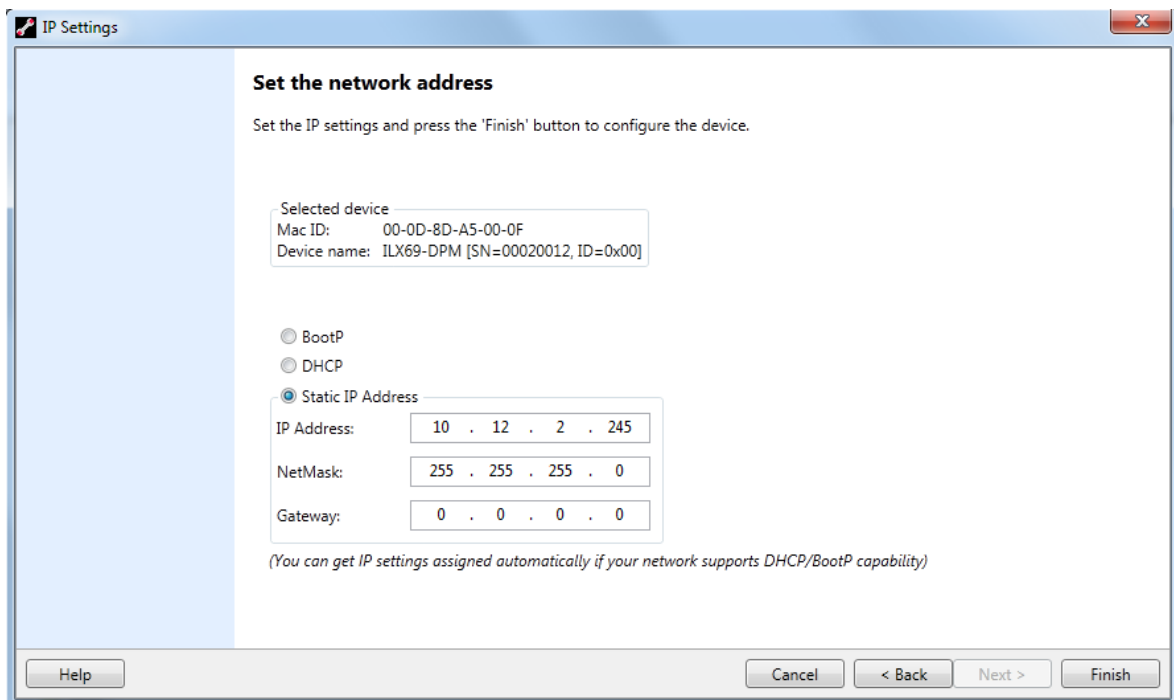

- 5 When ready, click **FINISH** to download the IP address information to the ILX69-PBM. The module reboots during this process.
- 6 When prompted, click **OK** when complete.

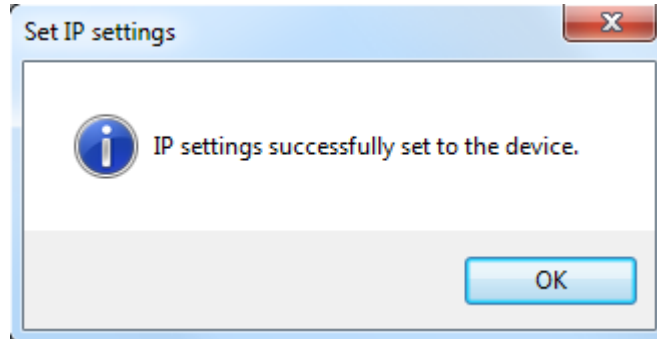

5.3.2 Downloading the Project

- 1 Double-click on the **DEVICE ASSIGNMENT** selection in the *Solution Explorer* pane. In the *Device Assignment* view, make sure the ILX69-PBM device is selected.

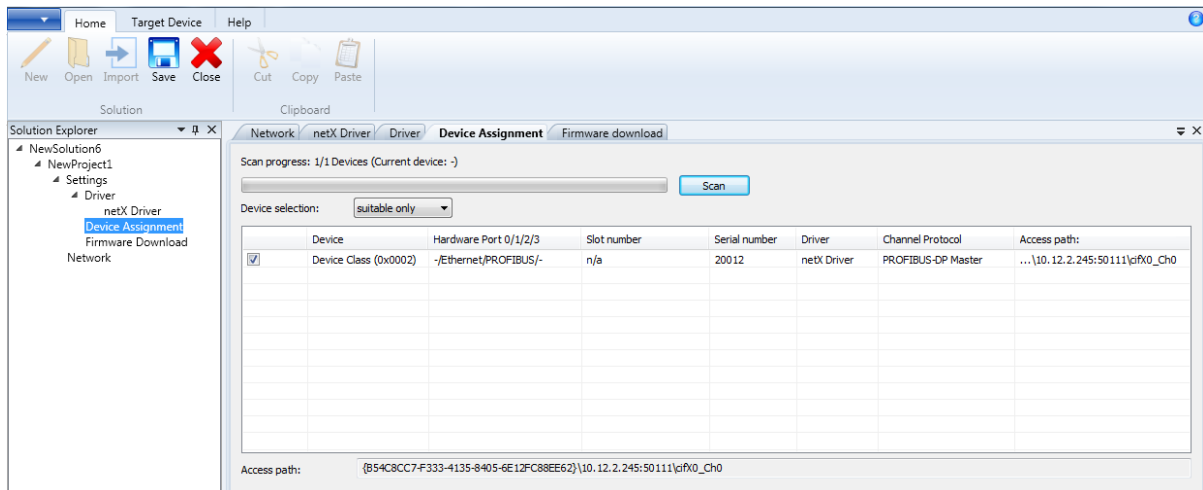

- 2 Double-click on the **NETWORK** selection in the *Solution Explorer* pane to return to the *Network* view.

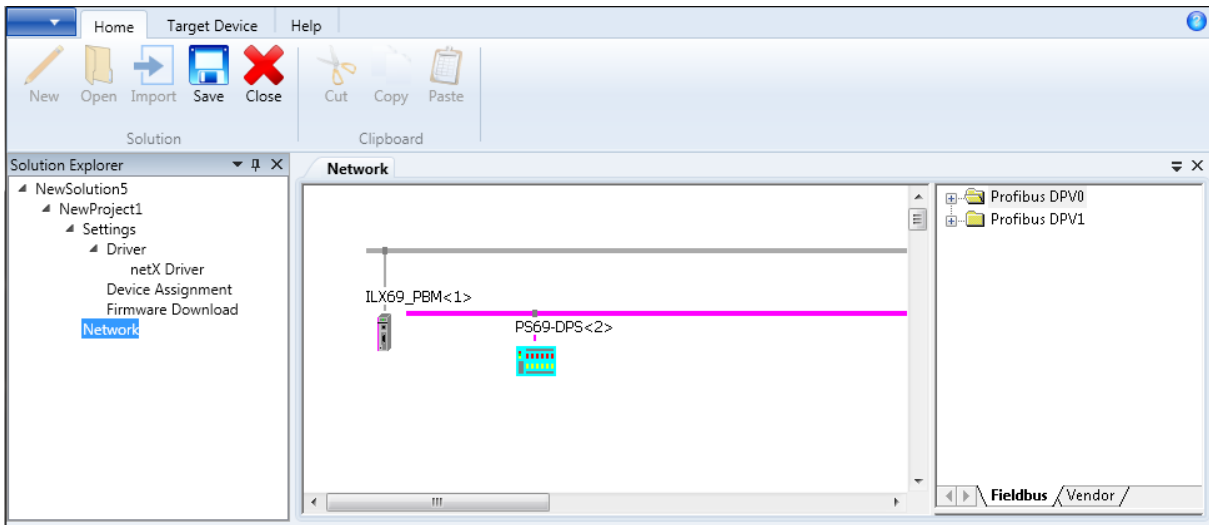

- 3 Right-click on the **ILX69_PBM** icon and select **DOWNLOAD**. (You can also highlight the *ILX69-PBM* icon and select **DEVICE > DOWNLOAD** from the top menu).

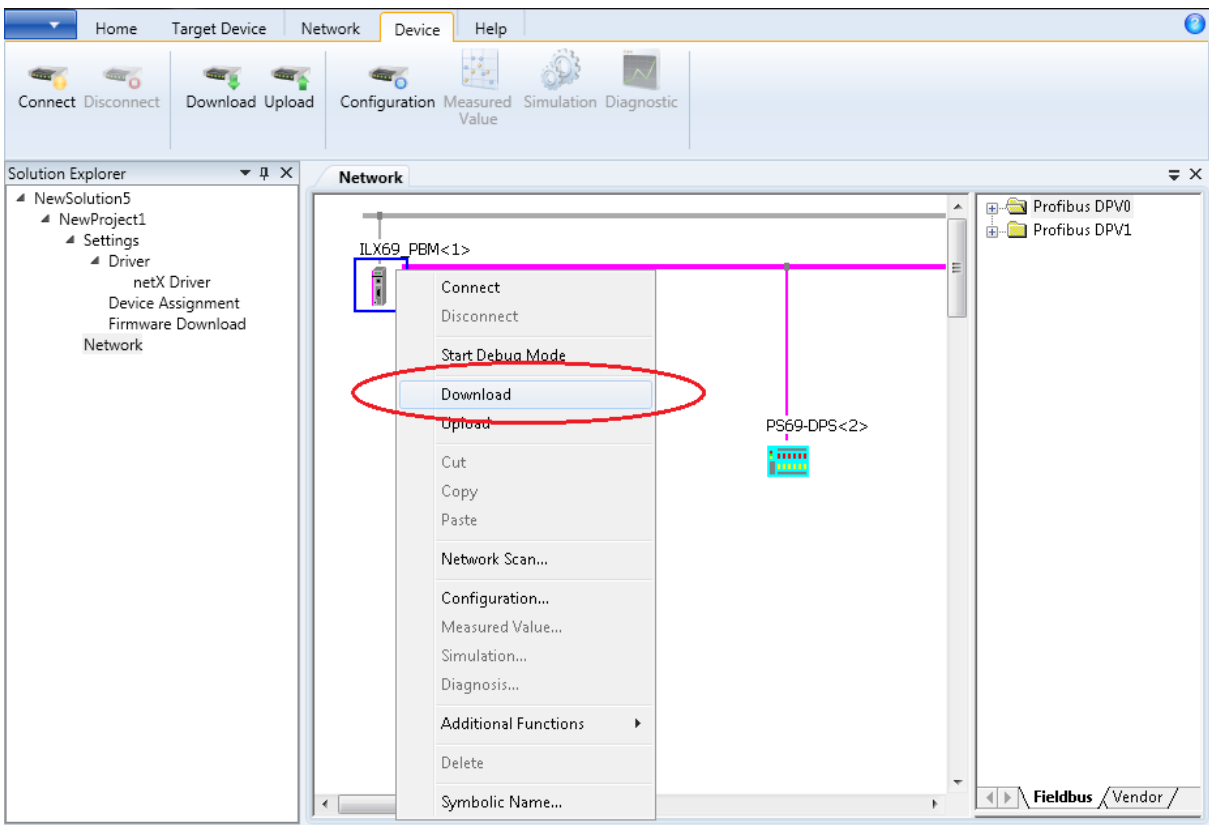

- 4 PROFIBUS network communications are stopped during configuration download. When ready to download, click **YES**.

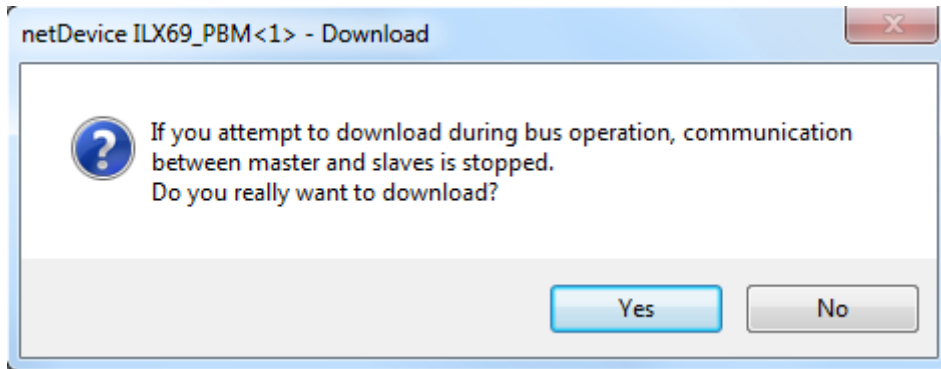

- 5 The configuration download begins.

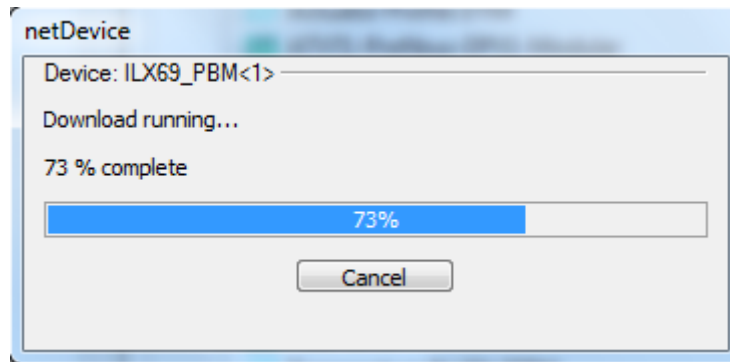

- The pane at the bottom of the window logs the project activity. The status of the download is shown here.

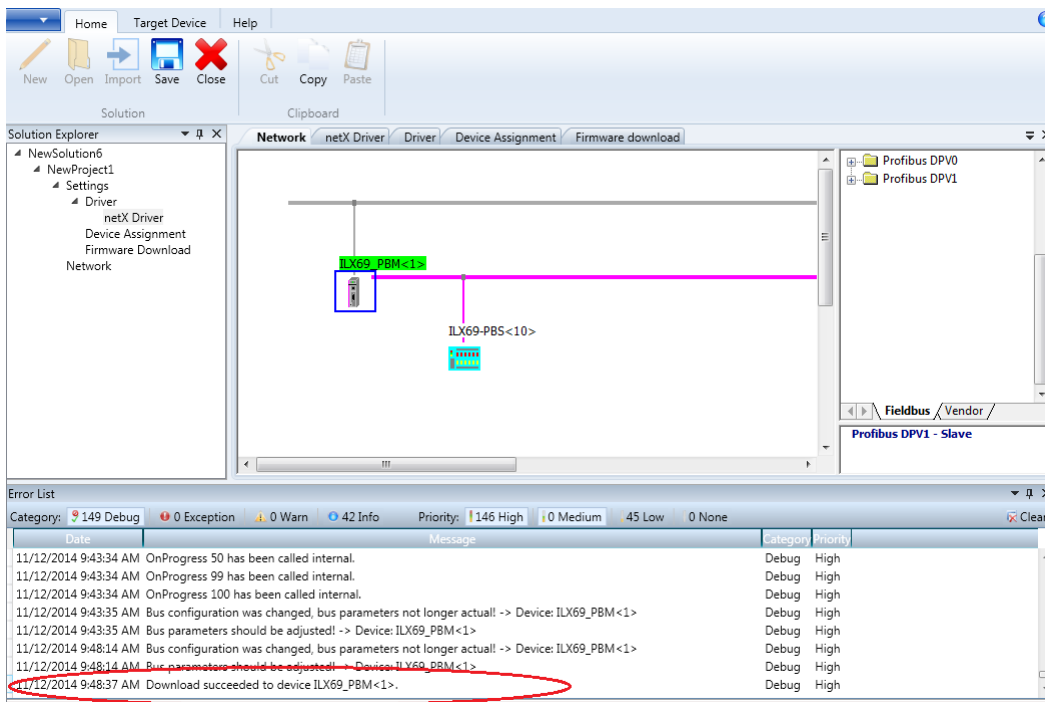

- With a successful download, the ILX69-PBM is now active on the PROFIBUS network with the new configuration.

5.4 Adjusting Input/Output Data Lengths in the Project

If you are using less than 408 bytes of input or 480 bytes of output data, the AOI can be adjusted to fit the needs of your PROFIBUS network. This section shows you how to determine the size and parameters to adjust.

5.4.1 Determining the Number of PROFIBUS Inputs/Outputs Used

The ProSoft fdt Configuration Manager shows the total number of inputs and outputs assigned to all slaves on the PROFIBUS network. This information is used to determine the adjustment needed in Studio 5000.

- 1 In the ProSoft fdt Configuration Manager, double-click on the **ILX69_PBM** icon in the *Network* view.

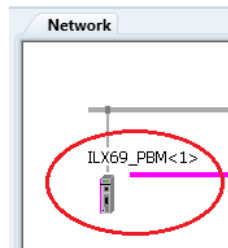

- 2 In the *Configuration ILX69_PBM* dialog, select the **ADDRESS TABLE** option to display the individual inputs and outputs assigned to each slave. The example below shows 8 bytes of input and 8 bytes of output assigned to slave 2. This is the only slave on the PROFIBUS network.

Notice as the inputs/outputs are added, they accumulate numerically

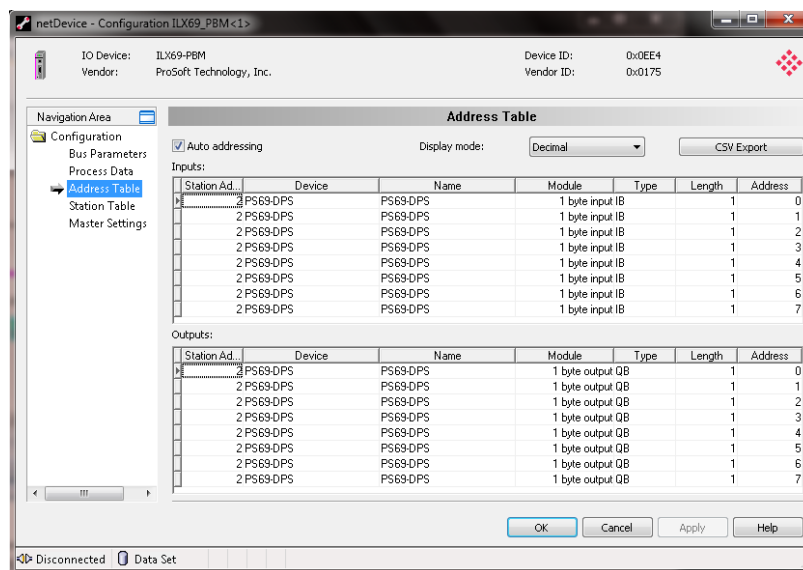

- 3 Using this information, the necessary adjustments in Studio 5000 can be made.

5.4.2 Studio 5000 Adjustment (Optional)

This (optional) section allows you to tailor the ILX69-PBM input/output sizes to conserve memory space in the CompactLogix™ processor.

Module Properties

- 1 With the CompactLogix controller in **Offline** mode, double-click on the **MODULE PBM** in the *I/O Configuration* dialog to open the *Module Properties*.

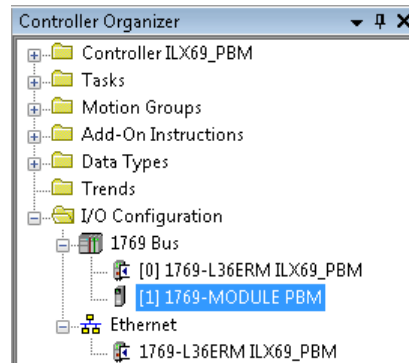

- 2 In the *Module Properties* dialog, edit the *Connection Parameters* **INPUT SIZE** to the sum of PROFIBUS Input **words** + 44.

In the example, there are 8 PROFIBUS input bytes, or (4) 16-bit words: $4 + 44 = 48$.

For outputs, edit the *Connection Parameters* **OUTPUT SIZE** to the sum of PROFIBUS Output **words** + 8.

In the example, there are 8 PROFIBUS output bytes, or (4) 16-bit words: $4 + 8 = 12$.

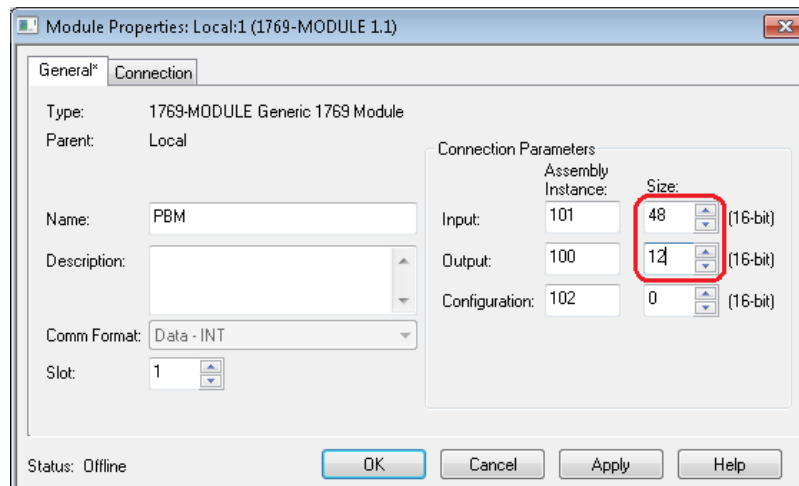

- 3 Click **APPLY**, then **OK**.

Add-On Instruction Definition

- 1 Double-click on the **AOILX69PBM** Add-On-Defined Data Type to open the *Add-On Instruction Definition* dialog.

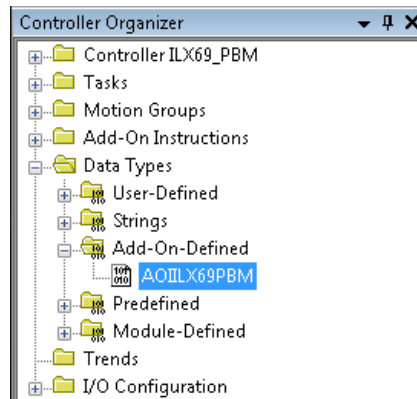

- 2 Under the *Parameters* tab, edit the *Connection_Input* Data Type size to the sum of PROFIBUS Input **words** + 44.

In the example, there are 8 PROFIBUS input bytes, or (4) 16-bit words: $4 + 44 = 48$.

For outputs, edit the *Connection_Output* Data Type size to the sum of PROFIBUS Output **words** + 8.

In the example, there are 8 PROFIBUS output bytes, or (4) 16-bit words: $4 + 8 = 12$.

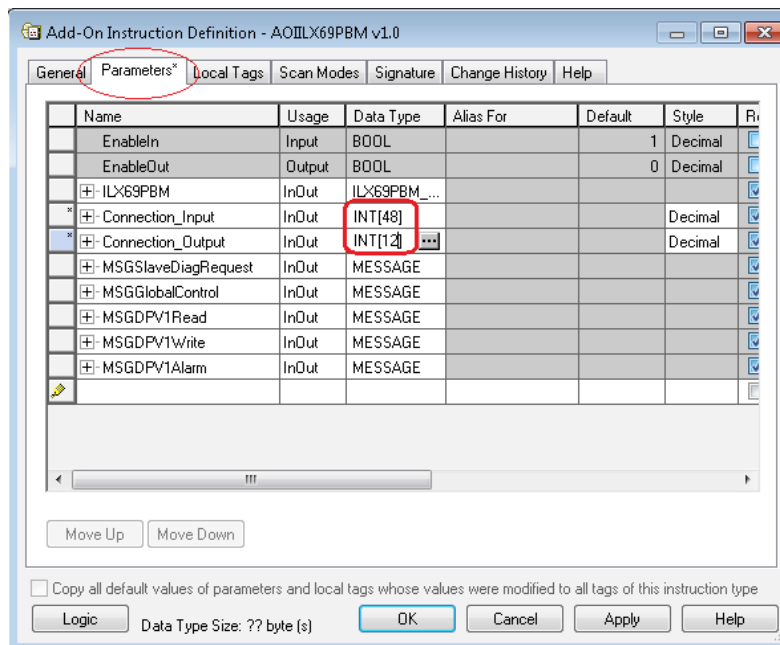

- 3 Click **APPLY**, then **OK**.

User-Defined Data Type

1 Double-click on the **EDIT_ILX69PBM_DATA** User-Defined Data Type (UDT).

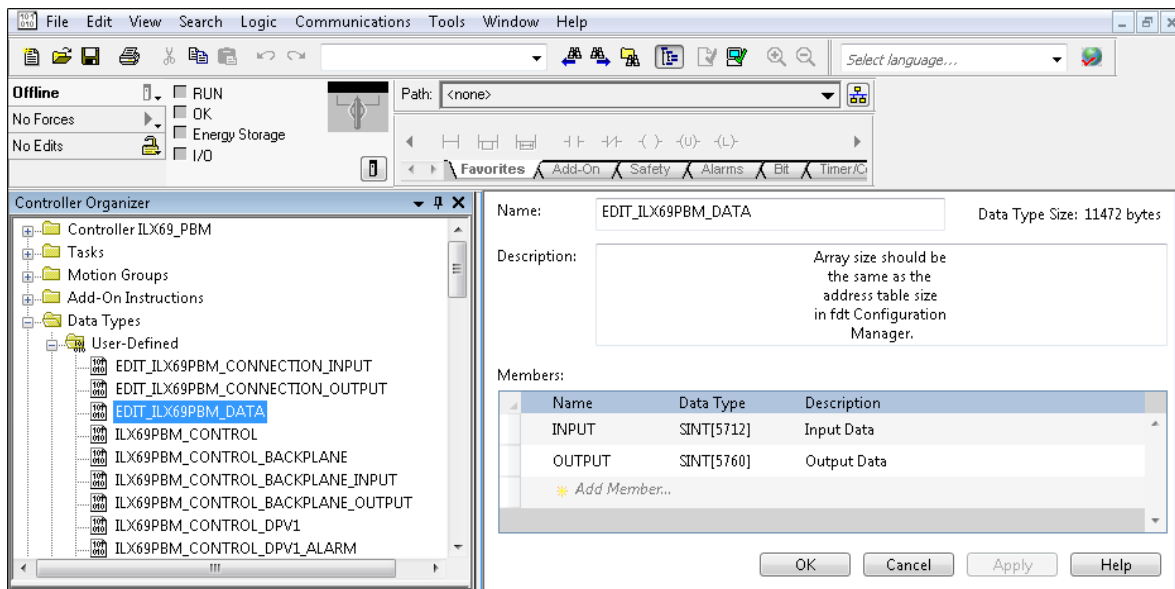

2 Edit the *SINT* Data Type array size to match the number of inputs and outputs assigned to the slaves in the PROFIBUS network, as defined in the ProSoft fdt Configuration Manager. The example uses 8 inputs and 8 outputs total.

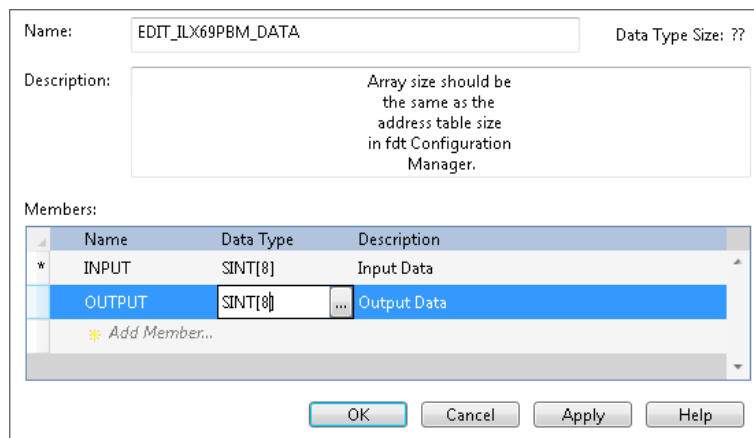

3 Click **APPLY**, then **OK**.

4 The *ILX69PBM.DATA.INPUT* and *OUTPUT* arrays reflect the changes.

[-] ILX69PBM.DATA	{...}	{...}		EDIT ILX6...
[+] ILX69PBM.DATA.INPUT	{...}	{...}	Decimal	SINT[8]
[+] ILX69PBM.DATA.OUTPUT	{...}	{...}	Decimal	SINT[8]

5 Save the project. The project is now ready to be downloaded to the 1769 controller.

5.5 Copying and Moving a Project

The ProSoft fdt Configuration Manager software does not have a **Save As** option. This section explains how to copy and move a project.

- 1 The project *Name*, *Location*, and *Solution Name* are all defined when creating a new project.

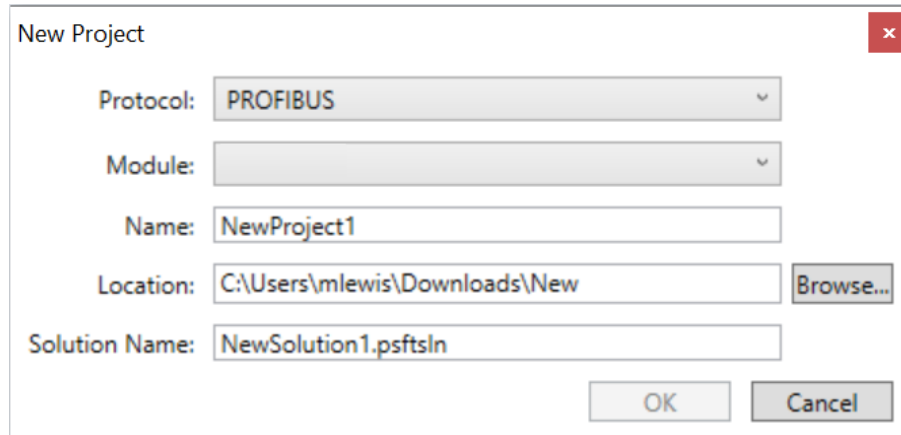

- 2 Browse to the folder location where the project was created/saved in.

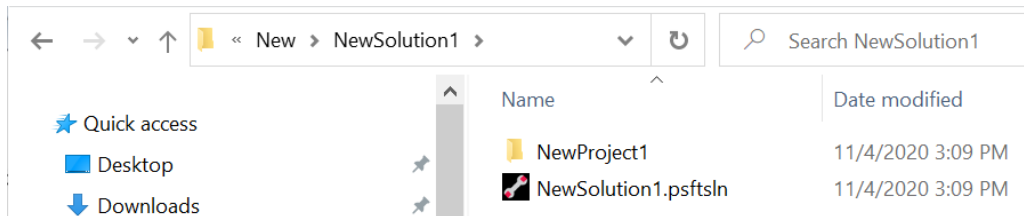

- 3 The user can rename the solution file, but cannot rename the project folder or any files within the folder.
- 4 The user can now copy or move the solution file and project folder to another location or PC.

5.6 Project Storage

The ProSoft fdt Configuration Manager provides procedures to store or restore project backup data directly to and from the ILX69-PBM internal flash memory. A 1:1 copy from the internal flash memory data can be made to an external SD memory card inserted into the module. The project backup data comprises of the ProSoft fdt Configuration Manager solution files, including the GSD files used in this solution. It is zipped as a single *config.zip* file.

The **STORE** function allows you to download the current project file with all related information, including GSD files. These are zipped together from the PC to the internal flash memory of the ILX69-PBM. This is allowed only if the user is logged in as Administrator (ProSoft fdt Configuration Manager User Access Control).

The **RESTORE** function allows you to upload the project data to the PC. This is helpful when the PC with the original configuration is not at your disposal. As the project backup is saved in the device via the *Restore* function, you can use the diagnostics functions in the ProSoft Configuration Manager. The functions *Store*, *Restore* and *Write to an SD* card are not available for legacy projects.



5.6.1 Store Function

If **Writing to SD Card** is checked (default setting) the ProSoft fdt Configuration Manager is making a 1:1 copy from the internal flash memory to the external SD memory card. The copy includes both the zipped 'project backup' and the existing device configuration files (firmware, configuration and Webpages).

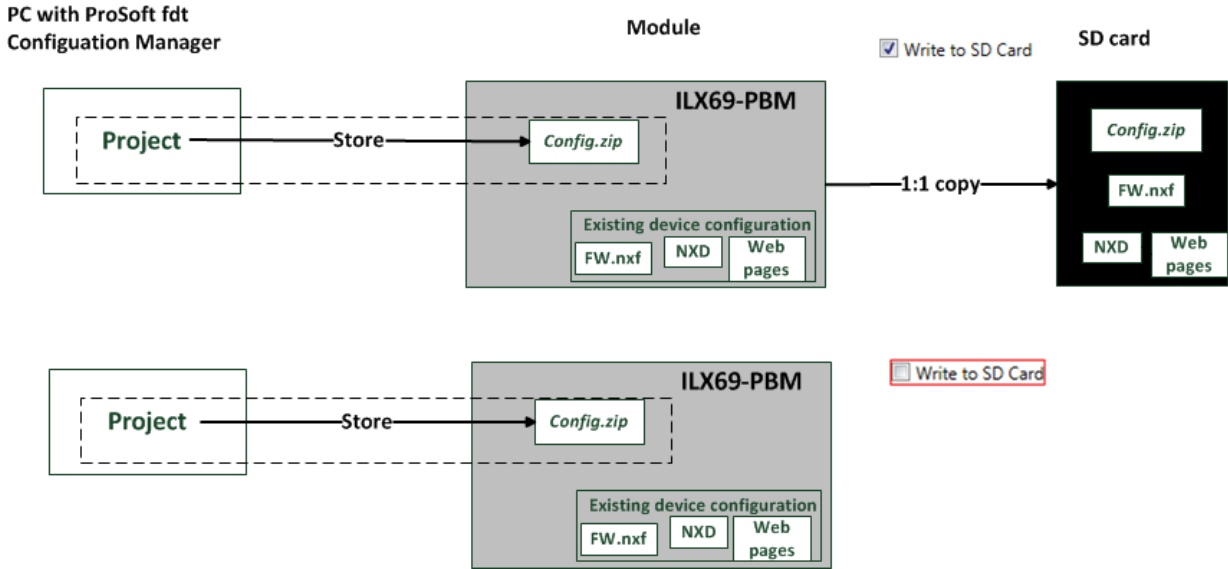

Important:

- Make a safe copy of the SD card data before you insert the SD card to the card slot. The **Store** function of ProSoft fdt Configuration Manager overwrites all existing data on the SD card.

5.6.2 Restore Function

Via the **Restore** button, you can upload the project backup data from the internal flash memory from the ILX69-PBM to the PC. The project backup data can only be restored from the internal flash, not from an external SD memory card.

To load the copied data from the external SD memory card to the internal flash of the ILX69-PBM, you must power cycle the module.

5.6.3 Project File Backup and SD Card Handling

Using an SD memory card makes it possible to load the same configuration (plus firmware and Webpages) into multiple ILX69-PBM modules without using a PC. The memory card must be prepared by a PC beforehand.

Restoring a configuration from an SD card can only be done when there is no backplane communications between the ILX69-PBM and CompactLogix processor. Make sure that the CompactLogix processor is disconnected from the power supply in order to restore a configuration from the SD card.

Safety Precautions for the ILX69-PBM Installation

Obey to the following safety messages on personal injury when powering a disconnected PLC power supply.



⚠ WARNING

Lethal Electrical Shock caused by Parts with more than 50V!

- HAZARDOUS VOLTAGE is present inside of a powered PLC power supply module. The danger of a lethal electrical shock caused by parts with more than 50V may occur if you power a PLC power supply module when its housing is open.
- Strictly obey to all safety rules provided by the device manufacturer in the documentation.
- Disconnect the network power (power plug) from the power supply before you disconnect the module from the backplane.
- When you disconnect the PLC module from the power supply module, use end cap terminators and close the power supply module housing.



SD Memory Card

Prerequisite for Memory Cards

- Maximum capacity of 4 GByte.
- The memory card must be formatted in FAT format. The FAT12/16/32 formats are supported. The exFAT format is not supported.
- Memory cards of the type SD card (SD and SDHC both with SPI) can be used.

Steps to Prepare Memory Card

- 1 Create and save the project on a standard PC using the ProSoft fdt Configuration Manager or open an existing project.
- 2 Download the configuration from the PC to the ILX69-PBM. The configuration is stored in a non-volatile memory location within the module and will be available after power up.
- 3 Insert a formatted SD memory card into the SD card slot of the module.
- 4 Using the **Store** function in ProSoft fdt Configuration Manager, download the project into the ILX69-PBM internal flash memory. It will also copy the configuration from the internal flash memory to the SD memory card if the **Writing to SD Card** box is checked (default).

The SD memory card will contain the following files:

- STARTUP.INI
 - Firmware *.nxf
 - Database files
 - config.nxd (network configuration for PBM)
 - nwid.nxd (IP address settings)
 - Webpages
 - Project backup file config.zip
- 5 Once complete, remove the SD memory card from the module.

Steps to Transfer Files from Memory Card into the ILX69-PBM



Lethal Electrical Shock caused by Parts with more than 50V!

- Disconnect the network power (power plug) from the power supply before you disconnect the module from the backplane.
 - When you disconnect the PLC module from the power supply module, use end cap terminators and close the power supply module housing.
-



Important: Make sure that there are (valid) firmware or configuration database (NXD) files on the SD card. Otherwise, overwriting the content of the internal flash memory will leave no (valid) firmware or configuration database (NXD) file in the internal flash memory.

- 1 Insert the prepared SD memory card into the SD card slot of the ILX69-PBM until it snaps in.
- 2 Reconnect the power supply module to the network power.
All files from the SD memory card are copied into the non-volatile flash memory of the ILX69-PBM. For more information, see section Start-up Behavior with or without SD Card (page 57).
- 3 For a faster power-up sequence, remove the SD memory card from the ILX69-PBM since the copy operation is being executed again.

5.6.4 Start-up Behavior with or without SD Card

The start-up behavior of the ILX69-PBM depends on whether an SD memory card is inserted in the module or not.

Start-up without Memory Card

On power-up, the ILX69-PBM and the firmware are started and the configuration data is loaded from the CompactLogix processor using the Local:x:C.Data array into the ILX69-PBM internal flash memory. Depending on the amount of stored configuration data, this can last for approximately 4 seconds.

Start-up with Memory Card

The ILX69-PBM supports firmware upgrade utilizing an optional SD card. Contact ProSoft technical support to obtain this firmware image. Firmware can also be loaded via the ILX69-PBM webpage. Configuration of the module is always obtained from the Local:x:C.Data array from the CompactLogix processor.

On power-up, the firmware data are restored from the SD memory card flash image into the ILX69-PBM internal flash memory only when the ILX69-PBM is not connected over the backplane to a CompactLogix processor. The following is the power-up sequence:

- After return of power, the SYS LED indicates a fast blinking in green for approximately 10 seconds. During this time the SD memory card can be removed from the module to prevent the data transfer.
 - After 10 seconds, the following files are transferred from the SD memory card into the non-volatile flash memory of the ILX69-PBM:
 - Firmware *.nxf
 - Webpages

This operation takes (typically) up to 30 seconds. During this operation the SYS LED is static yellow.

- When complete, the new firmware starts automatically and the ILX69-PBM boots with the new configuration. The COM LED illuminates or blinks as described in section Communication Status (page 102). Connection over the backplane to the CompactLogix processor can then be restored.

5.6.5 *STARTUP.INI File*

The STARTUP.INI file contains the following:

```
1 [Global]
2 Notify=10
3 Restore=always
4 RestorePoint=SDMMC:/backup
```

Notify=10: The value for 'Notify' is '10'. It takes 10 seconds to copy the files from the SD memory card to the internal flash of the ILX69-PBM.

Restore=always: The second stage bootloader copies the files in any case.

RestorePoint=SDMMC:/backup: All data stored under the backup folder is copied to the SD memory card.



Note: The STARTUPINI file is automatically created if 'Store' and

Write to SD Card

are used. The user does not need to create this file.

5.6.6 *Reset Device to Factory Settings with Memory Card*

Using a memory card that has the basic firmware stored on it, the ILX69-PBM can be restored back to factory settings.

- 1 Copy the STARTUP.INI file and the backup directory (including all subdirectories) from the ILX69-PBM webpage at www.prosoft-technology.com into the root directory of an empty memory card.
- 2 Prepare the memory card and reset the module to the factory settings as described in section Project File Backup and SD Card Handling (page 55).

6 Communication

6.1 Studio 5000 PROFIBUS Data Values

The ILX69-PBM PROFIBUS network data values (input and output) are located in the Controller Tags of Studio 5000.

6.1.1 PROFIBUS Network Input Data

The PROFIBUS network input data is stored in the ILX69PBM.DATA.INPUT array. All incoming data received from the PROFIBUS slaves is stored here.

[-] ILX69PBM	{...}
[-] ILX69PBM.DATA	{...}
[-] ILX69PBM.DATA.INPUT	{...}
[+] ILX69PBM.DATA.INPUT[0]	0
[+] ILX69PBM.DATA.INPUT[1]	0
[+] ILX69PBM.DATA.INPUT[2]	0
[+] ILX69PBM.DATA.INPUT[3]	0
[+] ILX69PBM.DATA.INPUT[4]	0
[+] ILX69PBM.DATA.INPUT[5]	0
[+] ILX69PBM.DATA.INPUT[6]	0

6.1.2 PROFIBUS Network Output Data

The PROFIBUS network output data is stored in the ILX69PBM.DATA.OUTPUT array. All outgoing data from the ILX69-PBM to be sent to the PROFIBUS slaves is to be placed here.

[-] ILX69PBM	{...}
[-] ILX69PBM.DATA	{...}
[+] ILX69PBM.DATA.INPUT	{...}
[-] ILX69PBM.DATA.OUTPUT	{...}
[+] ILX69PBM.DATA.OUTPUT[0]	0
[+] ILX69PBM.DATA.OUTPUT[1]	0
[+] ILX69PBM.DATA.OUTPUT[2]	0
[+] ILX69PBM.DATA.OUTPUT[3]	0
[+] ILX69PBM.DATA.OUTPUT[4]	0
[+] ILX69PBM.DATA.OUTPUT[5]	0
[+] ILX69PBM.DATA.OUTPUT[6]	0

6.2 I/O Communication and Memory Map

The following sections contain the I/O memory mappings of the ILX69-PBM. The I/O area is used for communication status, command information, and cyclic I/O data.

6.2.1 I/O Arrays Overview

Input Array

Below is a summary of the register layout of the input area of the ILX69-PBM. The offset values are defined in bytes.

Offset	Register Type	Name
0	Status Register	Module Status Bits
1	Status Register	Handshake Acknowledge Bits
2	Status Register	Block Transfer Out
3	Status Register	Block Transfer In
4	Firmware Revision	Minor Version
5	Firmware Revision	Major Version
6	Input Block Count	Input Block Count
7	Output Block Count	Output Block Count
8	Global State Field	Global Bits
9	Global State Field	DPM_State
10	Global State Field	Reserved[14], set to 0
24 to 39	Global State Field	SI_cfg[16]
40 to 55	Global State Field	SI_state[16]
56 to 71	Global State Field	SI_diag[16]
72	Slave Diagnostics Field	Slave Address
73	Slave Diagnostics Field	Slave Diag Failure
74	Slave Diagnostics Field	Station Status_1
75	Slave Diagnostics Field	Station Status_2
76	Slave Diagnostics Field	Station Status_3
77	Slave Diagnostics Field	Master Address
78 to 79	Slave Diagnostics Field	Ident Number
80	DPV1 Alarm Indication	Alarm_Status
81	DPV1 Alarm Indication	Rem_Add
82	DPV1 Alarm Indication	Alarm_Cnt
83	DPV1 Alarm Indication	Slot_Number
84	DPV1 Alarm Indication	Seq_Nr
85	DPV1 Alarm Indication	Alarm_Type
86	DPV1 Alarm Indication	Alarm_Spec
87	DPV1 Alarm Indication	Reserved, set to 0
88 to 495	PROFIBUS Input Area	Inputs[408] (5712 bytes in block transfer)

Output Array

Below is a summary of the register layout of the output area of the ILX69-PBM. The offset values are defined in bytes.

Offset	Register Type	Name
0	Device Command Register	Command Bits
1	Device Command Register	Handshake Request Bits
2	Device Command Register	Block Transfer Out
3	Device Command Register	Block Transfer In
4	Slave Diagnostic	Slave Address
5	Slave Diagnostic	Function
6	Slave Diagnostic	Reserved, set to 0
7	Slave Diagnostic	Reserved, set to 0
8	Global Control Command	Slave_Address
9	Global Control Command	Control_Command
10	Global Control Command	Group_Select
11	Global Control Command	Reserved, set to 0
12	Reserved Register	Reserved, set to 0
13	Reserved Register	Reserved, set to 0
14	Reserved Register	Reserved, set to 0
15	Reserved Register	Reserved, set to 0
16 to 495	PROFIBUS Output area	Outputs[480] (5760 bytes in block transfer)

6.2.2 Input Array

Device Status Registers

The ILX69-PBM uses the first 4 bytes of the input area to transfer the device status register information. The *Device Status Registers* contain the ILX69-PBM communication status and command status. The input area mapping of this information is shown below.

Device Status Registers

Byte Offset	Structure Member	Data Type	Description
0	MSB	SINT	Module Status Bit
1	HAS	SINT	Handshake Acknowledge Bits
2	BTO	INT	Block Transfer Out
3	BTI	INT	Block Transfer In

BTO - Block Transfer Out

The Logix program copies its output data into the output data area and writes the corresponding block number to OutBlock.Req (Block number 0 to n, with n = max. number of OUT blocks). The Logix program then checks if the requested block has been received by the module firmware by comparing OutBlock.Cnf and OutBlock.Req. If OutBlock.Cnf equals OutBlock.Req, the module firmware is ready to receive the next block. The procedure continues with a different block number.

If all blocks are transferred to the module, the Logix program will set the OutBlock.Req to 0 again. A transition from n to 0 in OutBlock.Req will trigger the module firmware to send all output data to the PROFIBUS network. This transition trigger ensures that all blocks are sent to the network consistently. The next block transfer of output data will be started over if the module detects a transition from 0 to n.

In order to send valid data, the Logix program must write all output data blocks and send it to the module firmware before the "Bus On" flag is set. In this case, the module firmware will send valid data to the slaves with the first network cycle. Therefore, the method "Controlled start of communication" must be selected in ProSoft fdt Configuration Manager.



A description of the option **Controlled by Application** can be found in the online help of the ILX69-PBM.

Respectively in the ILX69-PBM manual, ProSoft fdt Configuration Manager for CompactLogix or ControlLogix Platform, PROFIBUS DP Master DTM in chapter Configuration in the section Master Setting > Start of Bus Communication.

The module firmware copies the entire header portion (16 bytes) of the output data image in front of the data portion. The maximum size of the output data is 480 bytes for the first block and 480 for each of the following blocks. The Logix program would have to transfer 12 blocks in order to transfer 5760 bytes.

BTI - Block Transfer In

The module firmware starts sending network data to the Logix program as soon as the Logix program increments the block number in InBlock.Req (block number 0 ... m, with m = max number of IN blocks). The Logix program checks if the requested block was received by the module firmware by comparing if InBlock.Cnf equals InBlock.Req.

The Logix program then writes the next block number to InBlock.Req and the procedure starts over. If all blocks are transferred from the module firmware, the Logix program will set the InBlock.Req to 0. A transition from m to 0 is the trigger for the module firmware to refresh all input data from the PROFIBUS network. The trigger from 0 to 1 of InBlock.Req ensures that all transferred blocks are received consistently from the network.

The module firmware copies the entire header portion (88 byte) of the input data image in front of the data portion. The maximum size of the input data is 408 byte for the first block and 408 for each of the following blocks. The Logix program would have to transfer 15 blocks in order to transfer 5712 bytes.

Generally, the module firmware is capable of transferring data blocks in a non-sequenced manner. Additionally, a single block transfer is possible.

This is an example for 4 blocks:

Transition	Description
Partial block transfer for block 4	
0 => 4	Hold an input copy for block transfer and transfer block 4
4 => 0	Release input copy and update inputs
Partial block transfer for block 2	
0 => 2	Hold an input copy for block transfer and transfer block 2
2 => 0	Release input copy and update inputs
Partial block transfer for block 4 and 2	
0 => 4	Hold an input copy for block transfer and transfer block 4
4 => 2	Transfer block 2
2 => 0	Release input copy and update inputs
Full block transfer	
0 => 1	Hold an input copy for block transfer and transfer block 1
1 => 2	Transfer block 2
2 => 3	Transfer block 3
3 => 4	Transfer block 4
4 => 0	Release input copy and update inputs

Module Status Bits

Bit Offset	Structure Member	Data Type	Description
0	Reserved	BOOL	Reserved, set to 0
1	Reserved	BOOL	Reserved, set to 0
2	Reserved	BOOL	Reserved, set to 0
3	Reserved	BOOL	Reserved, set to 0
4	Reserved	BOOL	Reserved, set to 0
5	COM	BOOL	Communication; 0 = Not communicating, 1 = Communicating
6	RUN	BOOL	Run; 0 = Not running, 1 = Running
7	RDY	BOOL	Ready; 0 = Not ready, 1 = Ready

- **COM (Communication)**

When this bit is set, the communication is started and the module is engaged in cyclic data exchange with at least one of the connected slaves.

- **RUN (Run)**

When this bit is set, the module is ready for communication. Otherwise, an initialization error or incorrect parameterization has occurred. Further diagnostics is carried out with the ProSoft fdt Configuration Manager configuration software.

- **RDY (Ready)**

When this bit is set, the module is operational. The RDY bit should always be set by the module. If this bit is not set, a system error has occurred and the communication between controller and module is not possible.

HSR – Handshake Request Bits

Bit Offset	Data Type	Structure Member	Description
0	BOOL	HsReq0	Slave Diag Request
1	BOOL	HsReq1	Global Control Request
2	BOOL	HsReq2	Reserved, set to 0
3	BOOL	HsReq3	Reserved, set to 0
4	BOOL	HsReq4	Reserved, set to 0
5	BOOL	HsReq5	Reserved, set to 0
6	BOOL	HsReq6	Reserved, set to 0
7	BOOL	HsReq7	Reserved, set to 0

Using the handshake request bits, the user application can trigger different functions supported by the ILX69-PBM. Every handshake request bit (HsReq) has a corresponding handshake acknowledge bit (HsAck). It is located in the *Device Status Register* in the input array (see section Device Status Registers (page 61)).

If the module sets an HsReq bit unequal to the corresponding HsAck bit, the module will execute the command. If the module sets the corresponding HsAck bit equal to the HsReq bit, then the module has executed the command and the application can execute another command.



Note: The user application can only initiate a new command as long as the HsReq and the HsAck bits are equal.

HsReq0 – Handshake Request 0

The user program can use this bit to execute a Slave Diagnostics request. This bit is to be used with the SlvDiagCnf bit in the Handshake Acknowledge bits to determine if the command has been processed. See the section on Device Status Registers for more details.

HsReq1 – Handshake Request 1

The user program can use this bit to execute a Global Control command. This bit is to be used with the GlbCtrCnf bit to determine if the command has been processed. See the section on Device Status Registers for more details.

HsReq2...7 – Handshake Request 2 ... 7

Reserved for future use.

Firmware Revision

Bytes 4 to 7 contain the current *Firmware Revision* of the ILX69-PBM. The Minor revision is the low byte and the Major revision is the high byte. The mapping is shown in the table below.

Byte Offset	Structure Member	Data Type	Description
4	FwMinor	SINT	Firmware Minor Revision
5	FwMajor	SINT	Firmware Major Revision

Example:

If FwMajor = 10 and FwMinor = 1, the firmware revision is 10.1.

Due to a different internal firmware numbering scheme than Major/Minor version, the following method is used to utilize this information to support requirements for a major revision/minor revision of the CompactLogix controller. Because the first release of the ILX69-PBM internal firmware will start with at least V01.000, the first firmware version in Major Minor scheme will be at least 10.00. Details are provided in the table below.

FW Revision	FW Major	FW Minor
V01.000	10	00
V01.001	10	01
...		

Block Counts

Bytes 6 to 7 contain the Input and Output *Block Counts* of the ILX69-PBM.

Byte Offset	Structure Member	Data Type	Description
6	Input Block Count	SINT	Input Block Count
7	Output Block Count	SINT	Output Block Count

Global State Field

Bytes 8 to 71 contain the *Global State Field* registers. This field contains status information of the PROFIBUS DP system. The input area mapping of the *Global State Field* is shown in the table below.

Byte Offset	Structure member	Data Type	Signification	Explanation
8	Global_bits	BOOL	GLOBAL-BITS	Global error bits, for a detailed description of each bit and its meaning, see table below
9	DPM_State	SINT	PROFIBUS DP Master State	Main state of the PROFIBUS DP master system 00hex: OFFLINE 40hex: STOP 80hex: CLEAR C0hex: OPERATE
10 to 23	Reserved[14]	SINT(14)	Reserved	Reserved, 14 Bytes
24 to 39	SI_cfg[16]	SINT(16) = BOOL(128)	Slave Configuration Bit Array	If the SI_cfg bit of the corresponding slave is logical '1', the slave is configured in the master, and serviced in its states. If '0', the slave is not configured in the master
40 to 55	SI_state[16]	SINT(16) = BOOL(128)	Slave State Bit Array	If the SI_state bit of the corresponding slave station is logical '1', the slave and the master are exchanging their I/O data. If '0', the slave and the master are not exchanging their I/O data. The values in variable SI_state are only valid, if the master runs the main state OPERATE
56 to 71	SI_diag[16]	SINT(16) = BOOL(128)	Slave Diagnostics Bit Array	If the SI_diag bit of the corresponding slave station is logical '1', the latest received slave diagnostics data is available in the internal diagnostics buffer. This data can be read by the user with a message. If the value is '0' since the last diagnostics buffer read access of the slave, no values were changes in this buffer

GLOBAL-BITS

Bit Offset	Member Name	Data Type	Signification	Meaning if Bit is set
0	Ctrl	BOOL	CONTROL-ERROR	Parameterization error
1	Aclr	BOOL	AUTO-CLEAR-ERROR	Module stopped communication with all slaves and reached the auto-clear-end state.
2	Nexc	BOOL	NON-EXCHANGE-ERROR	At least one slave has not reached the data exchange state and no process data will be exchanged.
3	Fat	BOOL	FATAL-ERROR	Because of major bus error, no further bus communication is possible.
4	Eve	BOOL	EVENT-ERROR	The module has detected bus short circuits. The number of detected events is contained in the Bus_error_cnt variable. This bit is set when the first event was detected and will remain set.
5	NRdy	BOOL	HOST-NOT-READY-NOTIFICATION	Indicates if the Application program has set its state to operative or not. If this bit is set the Application program is not ready to communicate
6	Tout	BOOL	TIMEOUT-ERROR	The module has detected an overstepped timeout supervision value because of rejected PROFIBUS telegrams. It is an indication for bus short circuits while the master interrupts the communication. The number of detected timeouts is available in the Time_out_cnt variable. This bit will be set when the first timeout is detected and will remain set.
7	Reserved1	BOOL	Reserved	Reserved, set to 0

Byte Offset	Structure Member	Data Type	Description
24 to 39	Sl_cfg[16]	SINT(16)	List of Configured Slaves (Bit Field)
40 to 55	Sl_state[16]	SINT(16)	List of Activated Slaves (Bit Field)
56 to 71	Sl_diag[16]	SINT(16)	List of Faulted Slaves (Bit Field)

- **abSl_cfg[16] / Slave configuration area**

This variable is a field of 16 bytes and shows whether or not a certain slave station has been configured on the network. There is 1 bit for each slave. If set, the slave address has been configured. The following table shows the bit related to its slave address:

Bit	D7	D6	D5	D4	D3	D2	D1	D0
Offset								
24	7	6	5	4	3	2	1	0
25	15	14	13	12	11	10	9	8
26	23	22	21	20	19	18	17	16
...								
39	127	126	125	124	123	122	121	120

If the abSl_cfg bit of the corresponding slave is logically:

'1' - The slave is configured in the master, and serviced in its states.

'0' - The slave is not configured in the master.

- **abSl_state[16] / Slave state information area**

This variable is a field of 16 bytes and contains the state of each slave station. There is 1 bit for each slave. If set, the slave is present on the network. The following table shows the bit related to its slave station address:

Bit	D7	D6	D5	D4	D3	D2	D1	D0
Offset								
40	7	6	5	4	3	2	1	0
41	15	14	13	12	11	10	9	8
42	23	22	21	20	19	18	17	16
...								
55	127	126	125	124	123	122	121	120

If the abSl_state bit of the corresponding slave station is logically:

'1' - The slave and the master are exchanging their I/O data.

'0' - The slave and the master are not exchanging their I/O data.

• `abSl_diag[16]` / **Slave diagnostic area**

This variable is a field of 16 bytes containing the diagnostic bit of each slave. The following table shows the relationship between the slave station address and the corresponding bit in the variable `abSl_diag`.

Bit	D7	D6	D5	D4	D3	D2	D1	D0
Offset								
56	7	6	5	4	3	2	1	0
57	15	14	13	12	11	10	9	8
58	23	22	21	20	19	18	17	16
...								
71	127	126	125	124	123	122	121	120

If the `abSl_diag` bit of the corresponding slave is logically:

'1' - Latest received slave diagnostic data are available in the internal diagnostic buffer. This data can be read by the user with a message, as described in section Slave Diagnostic (page 85).

'0' - Since the last diagnostic buffer read access of the host, no values have been changed.

Slave Diagnostics Field

Bytes 72 to 79 contain the *Slave Diagnostics Field* information based on the settings used to execute this command.



Note: The Slave Diagnostics function can also be executed by CIP message functionality. Some CompactLogix™ controllers do not support messaging. This method can be used for controllers that only support I/O or I/O and CIP messaging. The slave diagnostics only gives the mandatory diagnostics information of a slave. Extended diagnostics information is received with the CIP message functionality only.

Byte Offset	Structure member	Data Type	Description
72	Slave Address	SINT	Address of slave with the diagnostics request
73	Slave Diag Failure	SINT	See Definition Below
74	Station Status_1	SINT	See Definition Below
75	Station Status_2	SINT	See Definition Below
76	Station Status_3	SINT	See Definition Below
77	Master Address	SINT	This byte contains the master address of the ILX69-PBM which has done the parameterization of the slave. If a slave is not parameterized, the value is 255.
78 to 79	Ident Number	INT	PROFIBUS Identification number from slave in which the diagnostics request was made.

Slave Diag Failure

This byte reflects the status of the Slave Diagnostics request.

Error Code	Significance	Error source	Description
0	Service could be executed without an error	No error	No error detected.
17	No response from the station	Slave	Check network wiring, bus address of slave, or baud rate support.
18	Master not in the logical token ring	Network in general	Check master DP address or highest-station address of the master. Examine bus wiring for short circuits.
161	Remote Address in request service is out of range	Application	Check address parameter in diagnostics request.

Station Status_1

Slave device status information.

Bit Offset	Member Name	Data Type	Description
0	Sta_Non_Exist	BOOL	No response from slave device. The slave is non-existent.
1	Sta_Not_Ready	BOOL	Slave is not ready
2	Cfg_Fault	BOOL	Slave has incorrect parameterization
3	Ext_Diag	BOOL	The extended diagnostics area is used
4	Not_Supp	BOOL	Unknown command is detected by the slave
5	Inv_Slv_Res	BOOL	Invalid slave response
6	Prm_Fault	BOOL	Last parameterization telegram was faulty
7	Master_Lock	BOOL	Slave is controlled by another master

Station Status_2

Slave device status information (continued)

Bit Offset	Member Name	Data Type	Description
0	Prm_Req	BOOL	Parameter Request: Slave must be parameterized
1	Stat_Diag	BOOL	This bit remains active until all diagnostics data has been retrieved from the slave
2	Slave_Device	BOOL	This bit is always set by the slave
3	WD_On	BOOL	Slave watchdog is activated
4	Freeze_Mode	BOOL	Freeze command active
5	Sync_Mode	BOOL	Sync command active
6	Reserved	BOOL	Reserved, set to 0
7	Deactivated	BOOL	Slave not active

Station Status_3

Slave device status information (continued)

Bit Offset	Member Name	Data Type	Description
0 to 6	Reserved0..6	BOOL	Reserved, set to 0
7	ExtDiagOverflow	BOOL	Slave has a large amount of diagnostics data and cannot send it all at once

DPV1 Alarm Indication

Bytes 80 to 87 contain the *DPV1 Alarm Indication* registers. These registers provide incoming alarm indication data required to respond to a DPV1 alarm that originates from a slave.

Byte Offset	Member Name	Data Type	Description
80	Alarm_Status	SINT	Status of Alarm Pending, see table below
81	AlarmCnt	SINT	Alarm Counter
82	Rem_Add	SINT	Address of slave with Alarm (0 to 126)
83	Slot_Number	SINT	Slot Number (0 to 254)
84	Seq_Nr	SINT	Sequence Number (0 to 31)
85	Alarm_Type	SINT	Alarm Type (1 to 6, 32 to 126)
86	Alarm_Spec	SINT	Alarm Specification (0 to 7)
87	Reserved	SINT	Reserved, set to 0

Alarm_Status

Bit Offset	Member Name	Data Type	Description
0	AlarmInd	BOOL	Alarm Indication
1	Reserved	BOOL	Reserved, set to 0
2	Reserved	BOOL	Reserved, set to 0
3	Reserved	BOOL	Reserved, set to 0
4	Reserved	BOOL	Reserved, set to 0
5	Reserved	BOOL	Reserved, set to 0
6	Reserved	BOOL	Reserved, set to 0
7	AlarmOverrun	BOOL	Alarm Overrun

The alarm indication registers start with the byte "Alarm_Status". This byte is a collection of bits to indicate alarm status. Bit D0 (AlarmInd) is set to "1" to alert the user application that an alarm request has been received by the ILX69-PBM.

The specifics of the alarm request are in the remaining alarm indication fields. It contains the slave station address "Rem_Add", the slot number "Slot_Number", etc. according to the PROFIBUS specification. If an alarm is indicated, the user application must decide what to do.

The application must respond to the alarm with a CIP message, described later in this manual. With its response to the slave, the user application confirms that the alarm was received. When the application responds to the alarm using a CIP message, Bit 0 will be set to "0" indicating that the alarm has been acknowledged and is no longer pending. The alarm information Rem_Adr, Slot_Number, etc. is not cleared.

It is possible that multiple alarms are pending. In this case, bit D0 will not be reset to "0" when the application has responded to one alarm. Only the alarm information Rem_Add, Slot_Number etc. will be updated in the case of multiple alarms pending.

To handle this situation, the application must also monitor the variable "AlarmCnt". This counter will be incremented every time a new alarm is pending.



Note: It is possible to receive several alarms from one or more slave. The ILX69-PBM has a buffer for only 32 alarms. The application must respond as fast as possible to alarms.

If the internal alarm buffer runs over, further alarms are lost. This situation is indicated by the "Alarm_Status" bit D7 "AlarmOverrun". If an alarm was lost, this bit is set to "1". It will be cleared only if the bus communication is stopped.

For example, if the controller stops or the application stops, the bus communication by the NRDY bit in the command register will trigger.

PROFIBUS Input Data

Bytes 88 to 495 is used for PROFIBUS input data received from the slaves. The input data is transferred from the module to the controller. Input data from the PROFIBUS system always starts at the 88th Byte (based on start index 0) in the input region. Thus, the module has a maximum of 408 bytes input data (496 byte input region – 88 byte status).

The input data of the slaves are linear corresponding to the I/O Mapping assigned by ProSoft fdt Configuration Manager. ProSoft fdt Configuration Manager is capable of configuring more than 408 Bytes of input data. Should the input data of the system exceed 408 bytes, the module and the sample ladder logic (AOI) will page the data until all the PROFIBUS Input data has been transferred.

6.2.3 Output Array

Device Command Registers

Bytes 0 to 3 contain the *Device Command Registers*. They are transferred from the controller to the module via the output region.

Device Command Registers

Byte Offset	Structure Member	Data Type	Description
0	MCB	SINT	Module Command Bits, see table below
1	HSR	SINT	Handshake Request Bits
2	BTO	INT	Block Transfer Out
3	BTI	INT	Block Transfer In

Module Command Bits

Bit Offset	Structure Member	Data Type	Description
0	Reserved	BOOL	Reserved, set to 0
1	Reserved	BOOL	Reserved, set to 0
2	Reserved	BOOL	Reserved, set to 0
3	Reserved	BOOL	Reserved, set to 0
4	Reserved	BOOL	Reserved, set to 0
5	NRDY	BOOL	Application Not Ready
6	Reserved	BOOL	Reserved, set to 0
7	RST	BOOL	Reset

- **NRDY – Not Ready**

Using this bit, the user program can start or stop the PROFIBUS network communications. When communications stop, all slaves go to fail safe mode and the master goes to Stop mode.

- **RST – Reset**

Using this bit, the user program can reset (Cold boot) the ILX69-PBM.



Important: Using the Reset command will cause an interruption in bus communication. All connected slaves will go to fail safe mode.

Handshake Acknowledge Bits

Bit Offset	Data Type	Structure Member	Description
0	BOOL	HsAck0	SlvDiagCnf , Slave Diag Confirmation
1	BOOL	HsAck1	GlbCtrCnf , Global Control Confirmation
2	BOOL	HsAck2	Reserved, set to 0
3	BOOL	HsAck3	Reserved, set to 0
4	BOOL	HsAck4	Reserved, set to 0
5	BOOL	HsAck5	Reserved, set to 0
6	BOOL	HsAck6	Reserved, set to 0
7	BOOL	HsAck7	Reserved, set to 0

The *Handshake Acknowledge Bits* provide an indication to a command that has been processed. Every handshake acknowledge bit has a corresponding handshake request bit. A command can be triggered by setting the corresponding handshake request bit in the device command register of the output array. If the handshake acknowledge bit is equal to the corresponding handshake request bit, the command has completed and the user program can begin the next command. If unequal, the command is still being processed.

- **HsAck0 – Handshake Acknowledge 0**

This bit indicates the processing of a slaveDiag request. If this bit is equal to *SlvDiagReq* in the Command register, the command has been processed. If unequal, the command is still in progress.

- **HsAck1 – Handshake Acknowledge 1**

This bit indicates the processing of a Global Control request. If this bit is equal to *GlbCtrlReq* in the Command register, the command has been processed. If unequal, the command is still in progress.

- **HsAck2..7 – Handshake Acknowledge 2 ... 7**

Reserved for future use.

Paging Mechanism / Block Transfer

The PLC program controls the block transfer of input and output data. The block transfer uses 2 bytes of the output data area and 2 bytes of the input data area. These byte pairs are located in the "Command Register" and "Status Register" area of the Input and Output image. Transferring input and output data is independent from each other. This allows exchanging process data using ladder logic even if the input and output size differ from each other.

The PLC program flows as: **Update inputs > Process data > Update outputs**

Slave Diagnostics Request Registers

Bytes 4 to 7 contain the *Slave Diagnostics Request Register*. In combination with the handshake request bits, these registers are used to provide an easy method to execute a diagnostics request to a specified PROFIBUS slave.

The Slave Diagnostics Command can be executed by using the corresponding handshake request bit HsReq0 in the Device Command Register (see section Device Command Registers (page 73)). The result of the Slave Diagnostics Command can be read in the Slave Diagnostics field of the input array.

Byte Offset	Data Type	Structure Member	Description
4	SINT	SLA	Slave Address
5	SINT	FNC	Function value
6	SINT	Reserved	Reserved
7	SINT	Reserved	Reserved

Slave Address

Address of the slave of which the diagnostics data are requested.

Function

If FNC is 0, the diagnostics data is requested from the internal buffer of the ILX69-PBM. This is the recommended method since the ILX69-PBM always has the most recent slave diagnostics data in its internal buffer.

If FNC is 1, the diagnostics data is requested directly from the slave itself. This is not the preferred method because it causes additional bus loading and will influence the bus cycle time.



Note: The same Slave Diagnostics function can also be executed by CIP message functionality described later in this manual. The slave diagnostics can only give the mandatory diagnostics information of a slave. Extended diagnostics information can be received with the CIP message functionality.

Global Control Registers

Bytes 8 to 11 contain the *Global Control Registers*. A Global Control request makes it possible to send commands to single or multiple slaves. This request makes it possible to do *Sync* and *Freeze* functions.



Note: The same Global Control function can be also executed by CIP message functionality described later in this manual.

Byte Offset	Data Type	Structure Member	Description
8	SINT	SLA	Slave Address
9	SINT	CC	Control Command, see table below
10	SINT	GS	Group Select, see table below
11	SINT	Reserved	Reserved

Slave Address

The SLA parameter allows the user to set the address of the slave in which the Global Control command is to be sent. The value of 127 is a special global broadcast address, all slaves are affected by this command at the same time.

Control Command

The CC parameter determines the function to be executed using the Global Control Command.

Bit Offset	Data Type	Structure Member	Description
0	BOOL	Reserved	Reserved
1	BOOL	Clear_data	Clear output data
2	BOOL	UnFreeze	Unfreeze input data
3	BOOL	Freeze	Freeze input data
4	BOOL	Unsync	Neutralize the sync command or unsync
5	BOOL	Sync	Freeze output data, until sync command is neutralized
6	BOOL	Reserved	Reserved
7	BOOL	Reserved	Reserved

Combination of the Unsync/Sync and Unfreeze/Freeze bits:

Bit 2 or 4	Bit 3 or 5	Description
0	0	No function
0	1	Function (sync or freeze) is active
1	0	Function (unsync or unfreeze) is active
1	1	Function (unsync or unfreeze) is active

Group_Select

The GS parameter allows the user program to select up to 8 possible slave groups to address by this service. This command is activated in the slave when the AND linkage between its internal Group_Ident and the desired Group_Select logic result is a '1'. The Group_Ident parameter is configured by the master during the startup phase.

If the Group_Ident parameter is set to a value of '0', the slave does not carry out a group evaluation (AND linkage) with the received command.

The Global Control Command is processed by using the two handshake bits *GlbCtrlReq* in the Device Command register and *GlbCtrlCnf* in the Device Status register. The command is sent on every High to Low **and** Low to High transition of the *GlbCtrlReq* bit. If both bits are equal, a command can be sent.

To send a command, configure the Global_Control_array with the desired command. Set the bits *GlbCtrlReq* and *GlbCtrlCnf* to unequal by transition of the *GlbCtrlReq* bit. If the *GlbCtrlCnf* was set equal to the *GlbCtrlReq* bit, the command was sent. The table below provides an explanation of this process.

GlbCtrlReq	GlbCtrlCnf	Description
0	0	No Control_Command is active. The next command can be sent.
1	0	Control command in progress
1	1	No Control_Command is active. The next command can be sent.
0	1	Control command in progress
0	0	Process repeats

PROFIBUS Output Data

Bytes 16 to 495 is used for PROFIBUS output data sent to the slaves. The output information is transferred from the controller to the module. Output data from the PROFIBUS system starts at the 16th byte (based on Start Index 0) in the output region.

Thus, the module has a maximum of 480 bytes output data for slave devices. The output data of the slaves are arranged in this area according to the I/O mapping table assigned by ProSoft fdt Configuration Manager. ProSoft fdt Configuration Manager is able to configure more than 480 bytes of output data, up to 5760 bytes. Should the output data be greater, the module and the sample ladder logic (AOI) will page the data until all the PROFIBUS Output data has been transferred.

6.3 Acyclic Messaging

PROFIBUS DP acyclic services are supported by the Studio 5000 programming tool by means of CIP messages using the "MSG" instruction. The ILX69-PBM sample ladder and AOI include multiple PROFIBUS acyclic services such as read/write and slave diagnostic request.

6.3.1 Supported PROFIBUS DP Messages

Below are the PROFIBUS DP message functions supported by the ILX69-PBM.

Service	Cmd Code	Group	Description
ILX69PBM_MSGDPV1Alarm	18	DPV1	Provides the means to acknowledge an alarm indication originating from a slave
ILX69PBM_MSGDPV1Read	17	DPV1	A read request for a particular data block is sent to a slave. This service is Slot- and Index-referenced.
ILX69PBM_MSGDPV1Write	17	DPV1	A write request is transferred to a slave, to write a particular data block in the slave. This service is Slot- and Index-referenced.
ILX69PBM_MSGSlaveControl	70	Standard	Sending a command to one or several slaves
ILX69PBM_MSGSlaveDiagRequest	66	Standard	Reading the diagnostics information from a slave

6.3.2 Standard Messaging

This section contains the description of each Standard Message function supported by the ILX69-PBM. The CIP MSG setup of this request is as follows.

Parameter	Value	Description
Message Type	CIP Generic	Common Industrial Protocol (CIP) messaging
Service Type	Custom	-
Service Code	64 hex	Service Code "Bridge Message"
Class	65 hex	CIP Object "CIP_MSG_BRIDGE"
Instance	1	An integer identification value assigned to an object instance that identifies it among all instances of the same class.
Attribute	0	A way of specifying a particular property or value within a CIP Object.
Source Element	-	Reference to a Tag of type ILX69PBM.CONTROL.SlaveDiagnostic.GetSlaveDiag
Destination	-	Reference to a Tag of type SlaveDiagnostic.GetSlaveDiag.Response
Source Length	16	Corresponds to the size of the ILX69PBM_MSGSlaveDiagRequest structure

Slave Diagnostic

The *Slave Diagnostic* request is used to query the status of a slave by its address. This request can be used to determine the general health of the slave device. The instruction Request / Confirmation format is as follows.

ILX69PBM.CONTROL.SlaveDiagnostic.GetSlaveDiag.

Parameter	Data Type	Value	Description
Initiate	BOOL	0x0000	Triggers the Get Slave Diagnostic command
Address	SINT	0 to 125	Slave address
Function	SINT	0 or 1	0 = Requested from Master 1 = Requested from Slave
MSGStatus	-	-	Message Status, see below

MSGStatus - Message Status

Parameter	Data Type	Description
Done	BOOL	Message Status is available
Error	BOOL	Last message was transmitted with an error
DoneCount	DINT	OK response count
ErrorCount	DINT	Error message count

ILX69PBM.CONTROL.SlaveDiagnostic.GetSlaveDiag.Response.

Name	Data Type	Description
SlaveAddress	SINT	Slave address
SlaveDiagnosticFailure	SINT	Slave Diagnostic Failure
StationNotExist	BOOL	No response from slave or the station does not exist.
StationNotReady	BOOL	Slave is not in a ready state
ConfigurationFault	BOOL	Configuration fault detected
ExtendedDiagnostic	BOOL	Extended diagnostics area is used
SyncFreezeNoSupport	BOOL	Unknown command is detected by the slave
InvalidResponse	BOOL	Invalid slave response
ParamterFault	BOOL	Last parameterization telegram was faulty
MasterLock	BOOL	Slave is controlled by another master
ParameterRequest	BOOL	Slave must be parameterized
StaticDiagnostic	BOOL	This bit remains active until all diagnostics data has been retrieved from the slave
Slave	BOOL	This bit is always set by the slave
Watchdog	BOOL	Slave watchdog is activated
FreezeMode	BOOL	Freeze command active
SyncMode	BOOL	Sync command active

Name	Data Type	Description
Reserved	BOOL	Reserved
SlaveDeactivated	BOOL	Slave not active
Reserved0...6	BOOL	Reserved
ExtendedDiagnostic Overflow	BOOL	Slave has a large amount of diagnostics data and cannot send it all
MasterAddress	SINT	Corresponding master address
IdentNumber	INT	PROFIBUS Identification number

Set Slave Control

This request makes it possible to send commands to one or several slaves. This request makes it possible to do Sync and Freeze functions. The MSG instruction Request / Confirmation format is as follows.

ILX69PBM.CONTROL.SlaveControl.SetSlaveControl.

Parameter	Data Type	Value	Description
Initiate	BOOL	0x0000	Triggers the Get Slave Diagnostic command
Address	SINT	0 to 125	Slave address
MSGStatus	-	-	Message Status, see below
SlaveCommand	-	-	Slave Command, see below

MSGStatus - Message Status

Parameter	Data Type	Description
Done	BOOL	Message Status is available
Error	BOOL	Last message was transmitted with an error
DoneCount	DINT	OK response count
ErrorCount	DINT	Error message count

SlaveCommand - Slave Command

Parameter	Data Type	Description
ClearData	BOOL	Clears output data
UnFreeze	BOOL	Unfreezes input data
Freeze	BOOL	Freezes input data
nSync	BOOL	Neutralizes the sync or unsync command
Sync	BOOL	Freezes output data until the sync command is neutralized
GroupSelect	SINT[8]	Group Select, see below.

Group Select

The *Group Select* parameter allows the user program to select which of the 8 possible slave groups is addressed by this service. This command is activated in the slave when the AND linkage between its internal *Group_Ident* and the desired *Group_Select* logic result in a '1'. The *Group_Ident* parameter is configured by the master during the startup phase.

If the *Group_Ident* parameter is set to a value of '0', the slave does not carry out a group evaluation (AND linkage) with the received command.

ILX69PBM.CONTROL.SlaveControl.SetSlaveControl_MSG.Response.

Parameter	Data Type	Value	Description
Status	DINT	0x0000	ILX69-PBM Status
Command	DINT	0x2221	Command code

6.3.3 DPV1 Messaging

This section describes DPV1 messaging functions supported by the ILX69-PBM.



Important: Do not configure DPV1 services if your controller does not allow CIP messaging.

DPV1 Read Command

The MSG instruction format of a DPV1 read command and response is as follows.

ILX69PBM.CONTROL.DPV1.Read.Request

Parameter	Data Type	Value	Description
.Status	DINT	0x0000	ILX69-PBM Status
.Command	DINT	0x2210	Command code
.SlaveAddresses	SINT	0 to 125	Slave address
.SlotNumber	SINT	0 to 255	Requested slot
.Index	SINT	0 to 255	Requested index
.Length	SINT	0 to 240	Requested length

ILX69PBM.CONTROL.DPV1.Read.Response

Name	Data Type	Value	Description
.Status	DINT	0x0000	ILX69-PBM Status
.Command	DINT	0x2211	Command code
.SlaveAddresses	SINT	0 to 125	Slave address
.SlotNumber	SINT	0 to 255	Slot number
.Index	SINT	0 to 255	Index
.Length	SINT	0 to 255	Data length
.Data	SINT[100]	0 to 240	Data returned from slave. If an error is returned, the first 2 bytes contain the error code.

DPV1 Write Command

The MSG instruction format of a DPV1 write command and response is as follows.

ILX69PBM.CONTROL.DPV1.Write.Request.

Parameter	Data Type	Value	Description
Status	DINT	0x0000	ILX69-PBM Status
Command	DINT	0x2212	Command code
SlaveAddress	SINT	0 to 125	Slave address
SlotNumber	SINT	0 to 255	Slot
Index	SINT	0 to 255	Index
Length	SINT	0 to 240	Data length
Data	SINT[100]	0 to 255	Data

ILX69PBM.CONTROL.DPV1.Write.Response.

Name	Data Type	Value	Description
Status	DINT	0x0000	ILX69-PBM Status
Command	DINT	0x2213	Command code
SlaveAddress	SINT	0 to 125	Slave address
SlotNumber	SINT	0 to 255	Slot
Index	SINT	0 to 255	Index
Length	SINT	0 to 255	Data length
Data	SINT[100]	0 to 240	Data returned from slave. If an error is returned, the first 2 bytes contain the error code.
ErrorDecode	SINT	128	DPV1 error detected
ErrorCode1	SINT	...	DPV1 Error Code 1
ErrorCode2	SINT	...	DPV1 Error Code 2
Reserved	SINT	-	N/A

DPV1 Alarm Response

This message is used to send a DPV1 Alarm Response to a slave device. The message acknowledges the alarm when the appropriate indication appears in the DPV1 Alarm indication area. The information mapped to this area must be used in the DPV1 Alarm Response message in order to process the alarm properly. The mapping of this information is as follows.

ILX69PBM.CONTROL.DPV1.Alarm.Request.

Parameter	Data Type	Value	Description
Status	DINT	0x0000	ILX69-PBM Status
Command	DINT	0x221C	Command code
SlaveAddress	SINT	0 to 125	Slave address causing the alarm
AlarmType	SINT	0 to 255	Type of alarm
SlotNumber	SINT	0 to 255	Slot number of slave causing the alarm
Specifier	SINT	0 to 255	Alarm specifier
Function	SINT	0	Reserved, set to 0
Reserved	SINT	-	N/A

ILX69PBM.CONTROL.DPV1.Alarm.Response.

Parameter	Data Type	Value	Description
Status	DINT	...	ILX69-PBM Status. 0 = OK
Command	DINT	0x221D	Command code
SlaveAddress	SINT	0 to 125	Slave address causing the alarm
AlarmType	SINT	0 to 255	Type of alarm
SlotNumber	SINT	0 to 255	Slot number of slave causing the alarm
Specifier	SINT	0 to 255	Alarm specifier
Function	SINT	0	Reserved, set to 0
ErrorDecode	SINT	0 to 255	A value of 128 indicates a DPV1 error
ErrorCode1	SINT	0 to 255	DPV1 Error code 1
ErrorCode2	SINT	0 to 255	DPV1 Error code 2

6.3.4 CIP Message Error Codes

This section includes error codes and conditions that can occur when using CIP messages.

Your application can be constructed in a manner in which it catches the two possible error cases:

- CIP Message instruction failure
- The requested command returns an error in its request confirmation

General CIP Message Error Codes

Below are general CIP Message error codes.



Note: Some CIP error codes are public and can also be generated by the controller.

CIP Status	Extended Status	Meaning	Cause	Help
02 hex	00CA hex	Resources unavailable Out of segments	System has no segments left to execute the command	
02 hex	03E8 hex	Resources unavailable Out of CIP com buffer	System has no CIP communication buffer left to execute the command	Check the number of parallel CIP messages sent to the module. The module can process 5 CIP messages in parallel. Note that RSLinx can already consume 2 of these CIP com buffers if the online browser is active.
02 hex	0519 hex	Resources unavailable Out of command buffer	System has no command buffer left to execute the command	Contact technical support
08 hex	0000 hex	Service not supported	The service code of the requested object is not supported	Check parameter of the CIP Message
14 hex	0000 hex	Attribute not supported	The attribute of the requested object is not supported	Check parameter of the CIP Message
13 hex	0000 hex	Insufficient data	Too little data was transferred with the CIP Message	Check the "Source Length" parameter of the CIP Message and check the consistency of all length parameters within the requested command.

15 hex	0000 hex	Configuration data size too large	Too much data transferred with the CIP Message	Check if the overall length of the requested command of the CIP message and the consistency of all length parameters within the requested command.
16 hex	0000 hex	Object not supported	The requested object does not exist within the module.	
FE hex	0000 hex	Message Timeout	No answer message was received.	
FF hex	0514 hex	General Error Non specified error occurred		Contact technical support
FF hex	0517 hex	General Error Unknown command	The value in the requested command is unknown	The value in requested command must be initialized

Slave Diagnostic

Code	Significance	Error source	Help
0	No error detected	N/A	N/A
17	No response from the station	Slave	Check network wiring, check bus address of slave or baud rate support
18	Master not into the logical token ring	Network in general	Check ILX69-PBM address or highest-station-address of the master. Examine bus wiring for bus short circuits.
161	Remote address in request service out of range	Host	Check parameter in request message

Set Slave Control

The Global Control command initiates a multicast command on the PROFIBUS network to all configured slaves. This command is always assumed to be successfully executed and no error will be placed in *Cnf.Failure* of the response message.

Code	Significance	Error source	Help
0	No error detected	N/A	N/A

DPV1 Read and Write

Code	Significance	Error source	Help
0 = CON_OK	Service was executed without an error	N/A	N/A
2 = CON_RR	Resource unavailable	Slave	Slave has no buffer space left for the requested service
3 = CON_RS	Requested function of master is not activated within the slave	Slave	Slave is not activated in its DPV1 support
9 = CON_NR	No answer-data, although the slave must respond with data	Slave	Slave has not sent any data back
17 = CON_NA	No response of the station	Slave	Check network wiring, check bus address of slave or baud rate support
18 = CON_DS	Master not in the logical token ring	Network in general	Check ILX69-PBM address or highest-station-address of other masters. Examine bus wiring to bus short circuits
25 = CON_NP	No plausible reaction of remote partner	Slave	Slave does not conform to DPV1 norm
54 = CON_AD	Negative response received, access denied	Slave	Access denied to requested data. Check ErrorCode1 and ErrorCode2 in response message for further error information
81 hex = REJ_SE	Device is about to stop the DPV1 communication or the DPV1 is not in OPEN state	Host, configuration	DPV1 communications must be configured to be activated by the device
82 hex = REJ_ABORT	Device has stopped the DPV1 communication automatically	Slave	A previously addressed slave has responded with non-conform parameters
83 hex = REJ_PS	A previous service is still in process	Host	Wait for the outstanding answer first. Parallel services are not allowed.
84 hex = REJ_LE	The length indicator msg.data_cnt exceeds maximum configured size	Host	Reduce length of message or enlarge maximum buffer size in ProSoft fdt Configuration Manager or in slave data set
85 hex = REJ_IV	Wrong parameter in request	Host	Check msg.function or msg.device_adr parameter of requested message
9a hex = REJ_COM	Unknown msg.b command	Host	Correct the requested msg.b parameter of message

DPV1 Alarm Response

Code	Significance	Error source	Help
86 hex = REJ_INT	The alarm handler is not initialized	Device	No DPV1 capable device configured within the module
87 hex = REJ_SRT	The alarm handler is currently stopped	Device	No DPV1 capable slave device is in process data exchange with the device. Check if network is running.
88 hex = REJ_ENA	The alarm that shall be acknowledged is not enabled in slave parameter data	Host	Enable the corresponding alarm in slave configuration data set
89 hex = REJ_NPD	The alarm that shall be acknowledged is not pending on a MSAL1_Alarm_Res	Host	Check the parameter AlarmType and Seq_Nr. Both must be equal to the MSAL1_Alarm_ind parameter
9a hex = REJ_COM	Unknown msg.b command	Host	Correct the requested msg.b parameter of message

7 Diagnostics and Troubleshooting

This chapter details the diagnostics and troubleshooting procedures for the ILX69-PBM.

7.1 Webpage

You can access the ILX69-PBM webpages for general device, diagnostics information, and firmware upgrades.

Access to the Webpage

- 1 Enter the IP address of the ILX69-PBM into an internet browser to access the homepage.

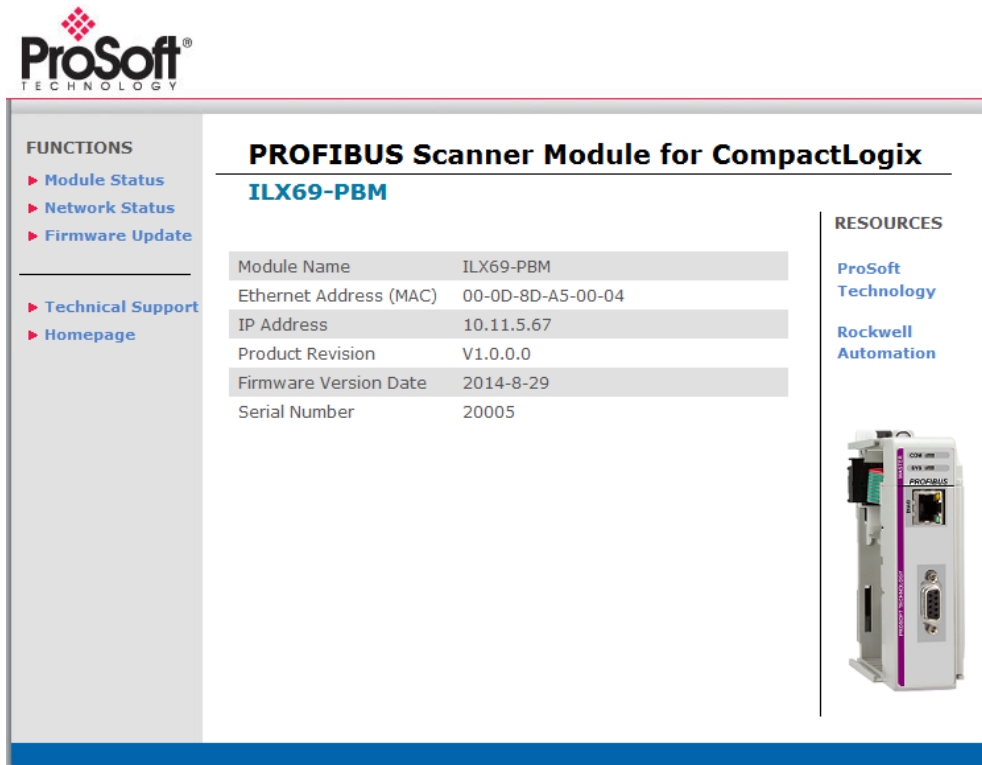

The screenshot displays the ProSoft Technology web interface for the PROFIBUS Scanner Module for CompactLogix ILX69-PBM. The interface includes a navigation menu on the left, a main content area with a table of device information, and a resources section on the right.

ProSoft TECHNOLOGY

FUNCTIONS

- ▶ [Module Status](#)
- ▶ [Network Status](#)
- ▶ [Firmware Update](#)
- ▶ [Technical Support](#)
- ▶ [Homepage](#)

PROFIBUS Scanner Module for CompactLogix
ILX69-PBM

Module Name	ILX69-PBM
Ethernet Address (MAC)	00-0D-8D-A5-00-04
IP Address	10.11.5.67
Product Revision	V1.0.0.0
Firmware Version Date	2014-8-29
Serial Number	20005

RESOURCES

- [ProSoft Technology](#)
- [Rockwell Automation](#)



7.1.1 General Device and Diagnosis Information

Homepage

To display the ILX69-PBM homepage, click **FUNCTIONS > Homepage**.

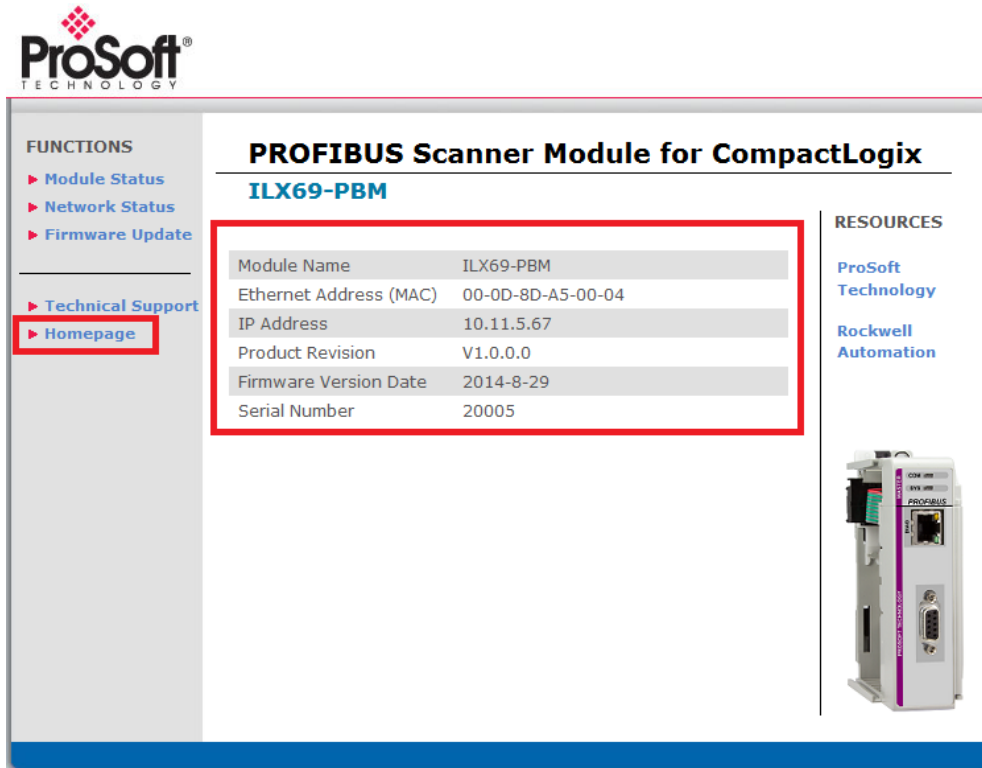

Parameter	Description	Range of Value/Value
Module Name	Name of the device as character string defined by the manufacturer	ILX69-PBM
Ethernet Address (MAC)	The MAC Address (=MAC-ID) is the unique (physical) Ethernet address of the device fixed by the manufacturer	Assigned MAC Address
IP Address	IP address of the ILX69-PBM that can be set via the ProSoft fdt Configuration Manager. The IP address must be unique. The IP address 0.0.0.0 indicates that no IP address has been configured yet.	Valid IP address
Product Revision	Revision of the ILX69-PBM firmware	V1.0.0.0 to VX.X.x.x
Firmware Version Date	Time stamp of the firmware	Year-Month-Day
Serial Number	Serial number of the ILX69-PBM	0 to 65535

Module Status

To display the ILX69-PBM status page, click **FUNCTIONS > Module Status** to access the device status and diagnostics information.

ProSoft
TECHNOLOGY

FUNCTIONS

- ▶ **Module Status**
- ▶ Network Status
- ▶ Firmware Update

PROFIBUS Scanner Module for CompactLogix
ILX69-PBM

Status	Configured
Uptime	0 days, 00:03:10
Network State	Offline
Communicating	No
Running	Yes
Ready	Yes
Error	Yes
Bus ON	No
Config Lock	No
Communication Error	0x00000000
Error Counter	0
Watchdog Time	0

RESOURCES

- [ProSoft Technology](#)
- [Rockwell Automation](#)

Parameter	Description	Range of Value/Value
Configuration State		
Status	Shows whether the ILX69-PBM is configured or not.	Configured, Not configured
Uptime	Counts up the time from the last Reset/Power On.	Days, hours, minute, seconds
Network State		
Network State	<p>Current status of the ILX69-PBM</p> <p>Operate: Shows whether the ILX69-PBM is in OPERATION state, e.g. in data exchange in cyclic communication. In a cyclic data exchange, the input data or the output data of the ILX69-PBM are transmitted to the slave.</p> <p>Idle: Shows whether the ILX69-PBM is in IDLE state.</p> <p>Stop: Shows whether the ILX69-PBM is in STOP state, e.g. no cyclic data exchange is performed. The ILX69-PBM was stopped by the CompactLogix program or it changed to the STOP state because of a bus error.</p> <p>Offline: Shows whether the ILX69-PBM is not in OPERATION state, e.g. no cyclic communication is performed. The ILX69-PBM is in OFFLINE state as long as it does not have a valid configuration.</p>	Operate, Idle, Stop, Offline
Device State		
Communicating	<p>Shows whether the PROFIBUS DP master executes the network communication.</p> <p>Yes: In COMMUNICATION state. The ILX69-PBM exchanges input/output data with at least one slave.</p> <p>No: Not in COMMUNICATION state. The ILX69-PBM does not exchange input/output data with slaves.</p>	Yes, No
Running	<p>Shows whether the ILX69-PBM has been configured correctly.</p> <p>Yes: Configuration OK</p> <p>No: Configuration not OK</p>	Yes, No
Ready	<p>Shows whether the ILX69-PBM has been started correctly. The ILX69-PBM waits for a configuration.</p> <p>Yes: Device is ready</p> <p>No: Device is not ready</p>	Yes, No
Error	<p>Shows whether the ILX69-PBM has detected an error.</p> <p>Yes: Error has been detected</p> <p>No: No error has been detected</p>	Yes, No
Configuration State		
Bus ON	<p>Shows whether the bus communication was started or stopped by the CompactLogix program.</p> <p>Yes: Bus communications have started</p> <p>No: Bus communications have not started</p>	Yes, No
Config Lock	<p>Configuration locked shows whether the ILX69-PBM configuration is locked, i.e. the configuration is protected against changes.</p> <p>Yes: Configuration is locked</p>	Yes, No

Parameter	Description	Range of Value/Value
	No: Configuration is not locked	
General Diagnostics		
Communication Error	Shows the communication error code. If the cause of the error is resolved, the value will be set to zero again. All possible numbers are listed in [1].	0x00000000 to 0xFFFFFFFF
Error Counter	Counter; counts up for each error event.	0x00000000 to 0xFFFFFFFF
Watchdog Time	The Watchdog time determines the time frame in which the device watchdog must be re-triggered from the CompactLogix program while the CompactLogix program monitoring is activated. When the watchdog time value is equal to 0, the watchdog is deactivated and the CompactLogix program monitoring is deactivated also. The permissible range of values of the watchdog time is 20 to 65535 ms. The default watchdog time is 1000 ms. With a watchdog time, the software watchdog is deactivated.	20 to 65535 ms Default: 1000 ms

Network Status

To display the ILX69-PBM network status page, click **FUNCTIONS > Network Status**. This page contains network status and diagnostics information.

ProSoft
TECHNOLOGY

FUNCTIONS

- ▶ Module Status
- ▶ **Network Status**
- ▶ Firmware Update

▶ Technical Support
 ▶ Homepage

PROFIBUS Scanner Module for CompactLogix
ILX69-PBM

Master State	Offline
Application State	Ready
Control Error	No
AutoClear Error	No
Non Exchange Error	No
Fatal Error	No
Timeout Error	No
Error Address	0
Error Event	0
Bus Error Counter	0
Bus Timeout Counter	0
Slaves	0 1 2 3 4 5 6 7 8 9
0	* * * * *
10	* * * * *
20	* * * * *
30	* * * * *
40	* * * * *
50	* * * * *
60	* * * * *
70	* * * * *
80	* * * * *
90	* * * * *
100	* * * * *
110	* * * * *
120	* * * * *

'*' - Not Configured,
 'N' - Not found,
 'R' - Running,
 'D' - Diagnostic,
 'E' - Error.

RESOURCES

[ProSoft Technology](#)
[Rockwell Automation](#)

Parameter	Description	Range of Value/Value
Master State	This variable represents the main state of the master system. 'Operate': The ILX69-PBM is in data exchange. In a data exchange, the inputs of the slaves are read and the output information is transferred to all slaves. 'Clear': The ILX69-PBM reads the input information of the slaves and holds the outputs of the slaves in a safe condition. 'Stop': The ILX69-PBM is in a Stop state that means no data exchange takes place between the ILX69-PBM and the slaves. The master was stopped by the CompactLogix program or it had to go into a Stop state because of a bus error. 'Offline': The ILX69-PBM does not exist on the bus, it is not online. This can happen if no or faulty bus parameters are set for the ILX69-PBM. Furthermore, this can happen if the correct bus parameters are set, but the CompactLogix program has not activated the ILX69-PBM for data exchange on the bus.	Operate, Clear, Stop, Offline
Application State	'Not ready': CompactLogix program has not yet started or stopped the ILX69-PBM. 'Ready': CompactLogix program has started the ILX69-PBM.	Ready, Not ready
Control Error	Displays that a parameterization error has occurred. 'Yes': Error detected 'No': No error detected	Yes, No
AutoClear Error	Displays that the device has stopped the communication to all slaves and it has reached the auto-clear end state. 'Yes': Error detected 'No': No error detected	Yes, No
Non Exchange Error	Displays that at least one slave is not in the cyclic data exchange with the ILX69-PBM. 'Yes': Error detected 'No': No error detected	Yes, No
Fatal Error	A fatal error has occurred. Because of a heavy bus error no further bus communication is possible. 'Yes': Error detected 'No': No error detected	Yes, No
Timeout Error	Indicates that the device has detected a skipped TIMEOUT supervision time because of rejected PROFIBUS telegrams. It is an indication for bus short circuits while the ILX69-PBM interrupts the communication. 'Yes': Error detected 'No': No error detected	Yes, No
Error Address	Displays the lowest station address that signals diagnostics	0 to 125
Error Event	Indicates the error code of the 'Error address'.	0x00000000 to 0xFFFFFFFF
Bus Error Counter	This value is increased whenever an increased number of faulty PROFIBUS frames were detected by the ILX69-PBM. It is a counter for heavy bus error events.	0 to 65535 (rollover possible)
Bus Timeout Counter	Counter for bus timeouts. It counts the number of rejected PROFIBUS telegrams because of heavy bus error.	0 to 65535 (rollover possible)
Slaves 0 to 127	Indicates whether a slave is not configured, not found, running, in diagnostics or whether an error has occurred for this slave.	'-' = Not Configured 'N' = Not found 'R' = Running 'D' = Diagnostic 'E' = Error

7.1.2 Firmware Update

Click **FUNCTIONS > Firmware Update** to access the firmware update page.

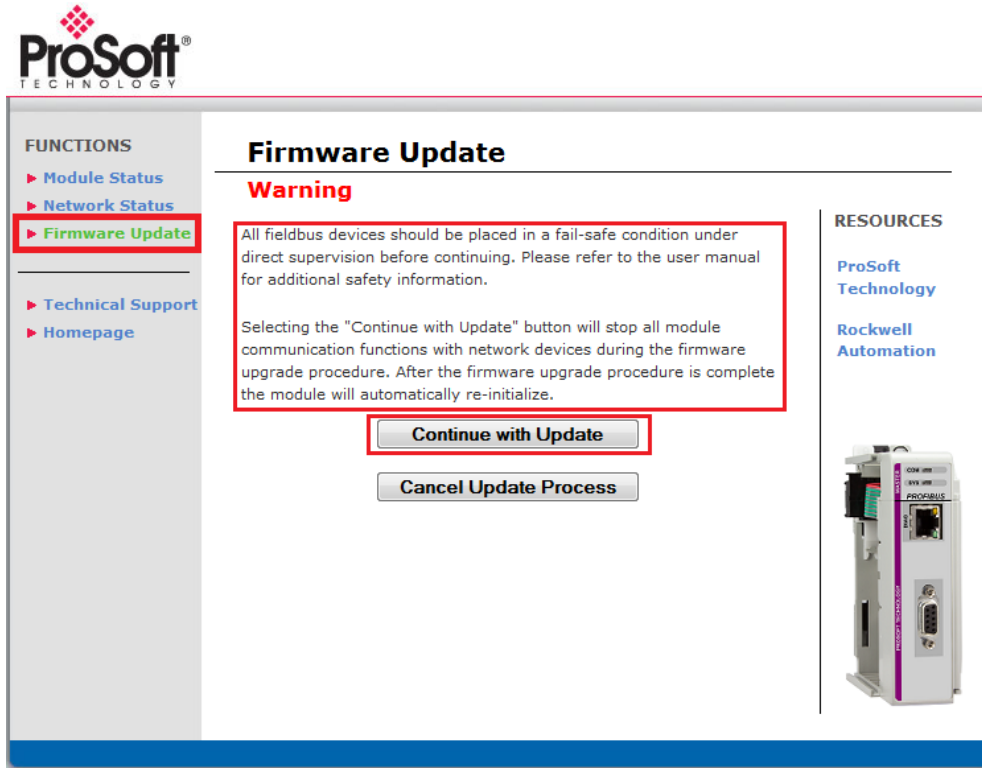

WARNING

- All fieldbus devices should be placed in a fail-safe condition under direct supervision before continuing.
- Selecting the **CONTINUE WITH UPDATE** button will stop all module communication functions with network devices during the firmware upgrade procedure.
- Stop the PLC program before you start the firmware update.

After the firmware upgrade procedure is complete, the module will automatically re-initialize.

- 1 To continue the firmware update, click **CONTINUE WITH UPDATE**. The firmware file prompt displays.

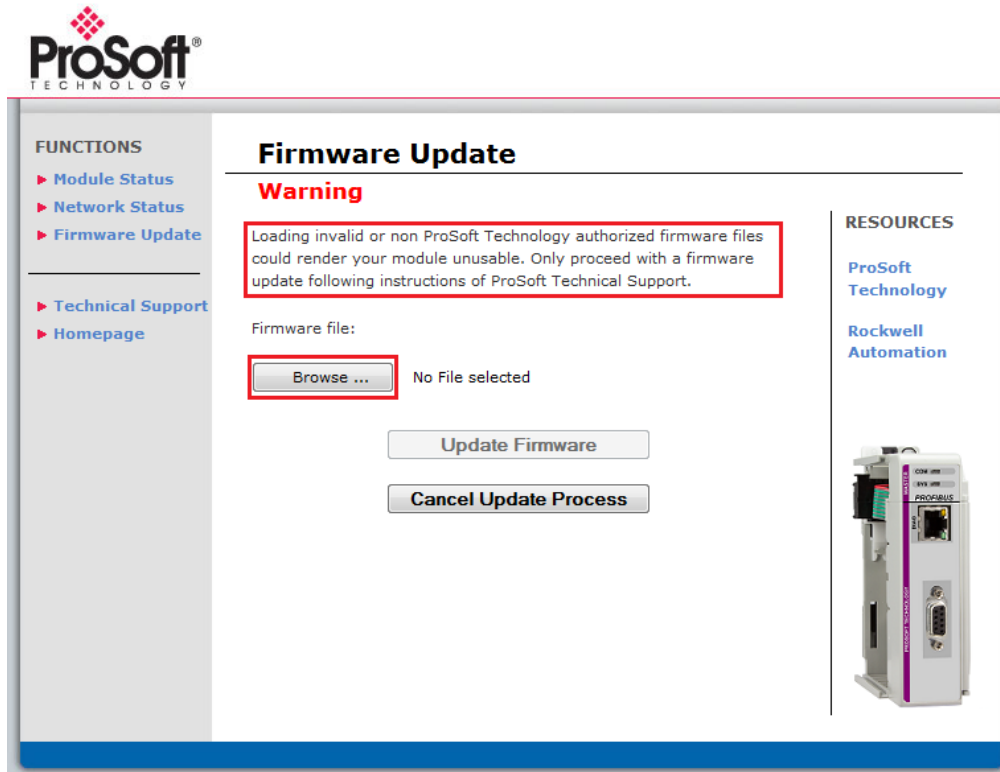

NOTICE

- Loading invalid or non-ProSoft Technology authorized firmware files could render your module unusable. Only proceed with a firmware update following instructions of ProSoft Technical Support.

- Click **BROWSE...** and enter 'User name' = 'admin' and 'Password' = 'admin' to the Authorization window, and then select the firmware file.

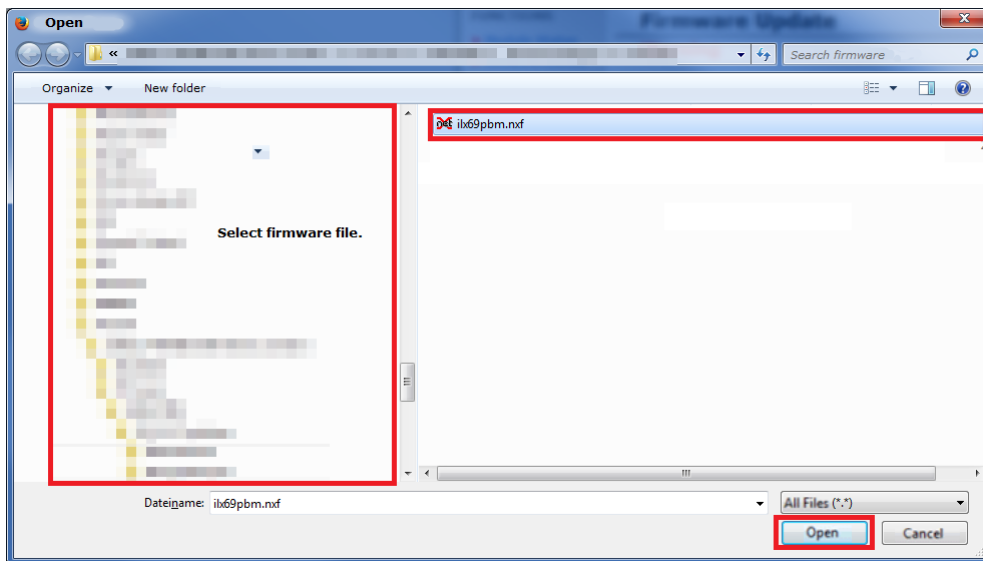

- Click **Open**. The name of the selected firmware file displays.

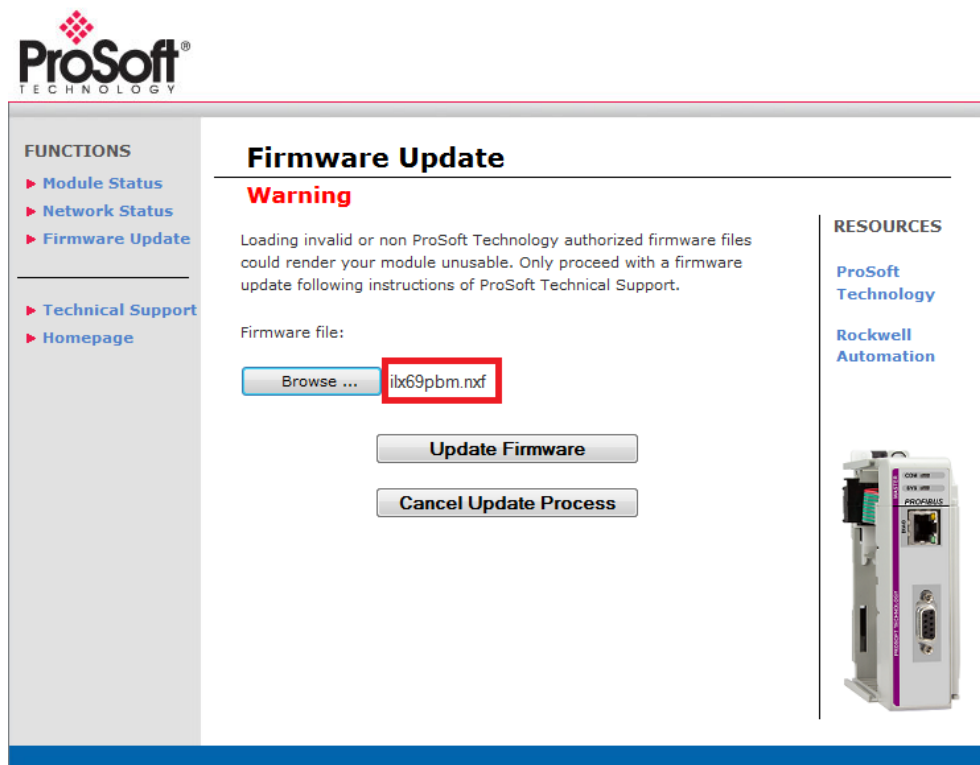

4 Click **Update Firmware**.

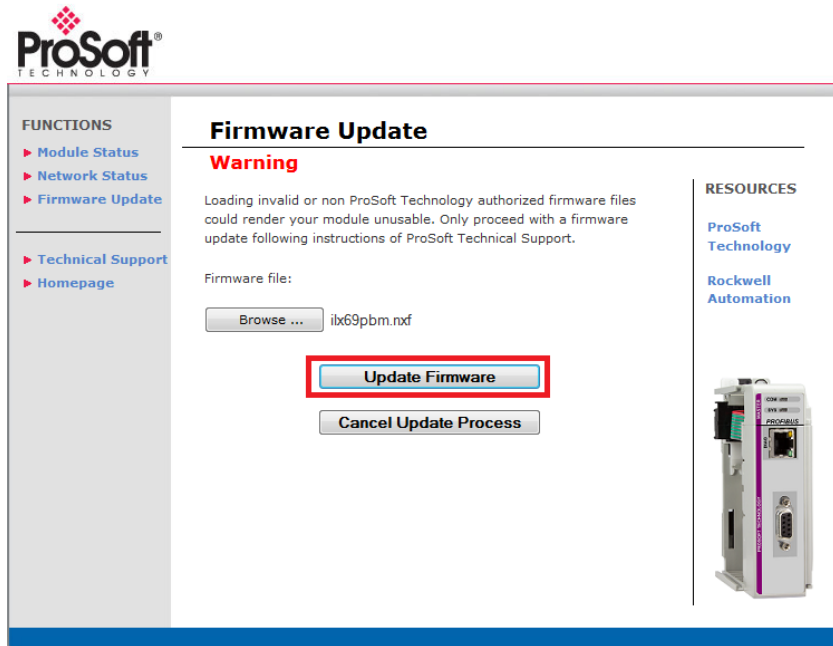

If the firmware update fails, the page shows an error message: *Firmware update error: Invalid device class.*

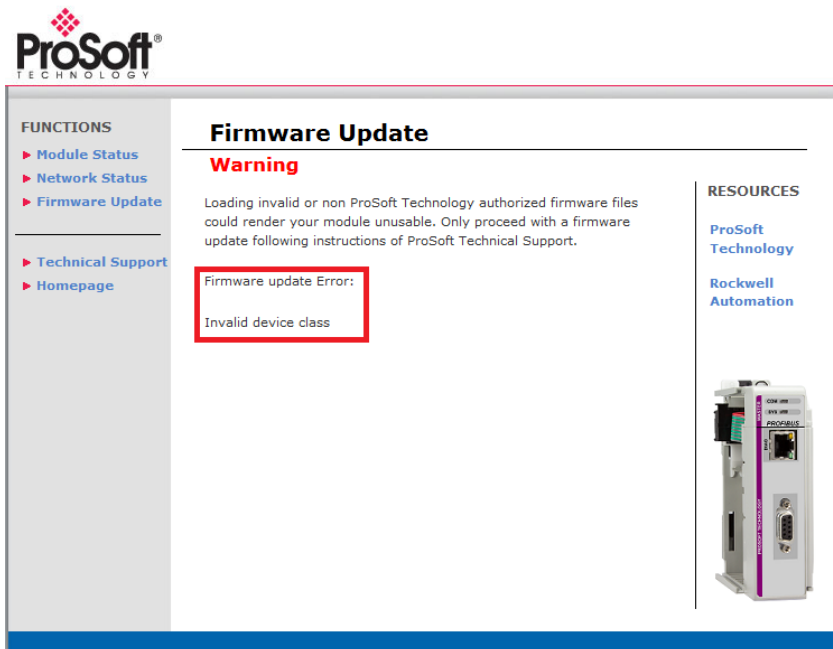

If the firmware update is successful, a *Firmware update OK* message displays.

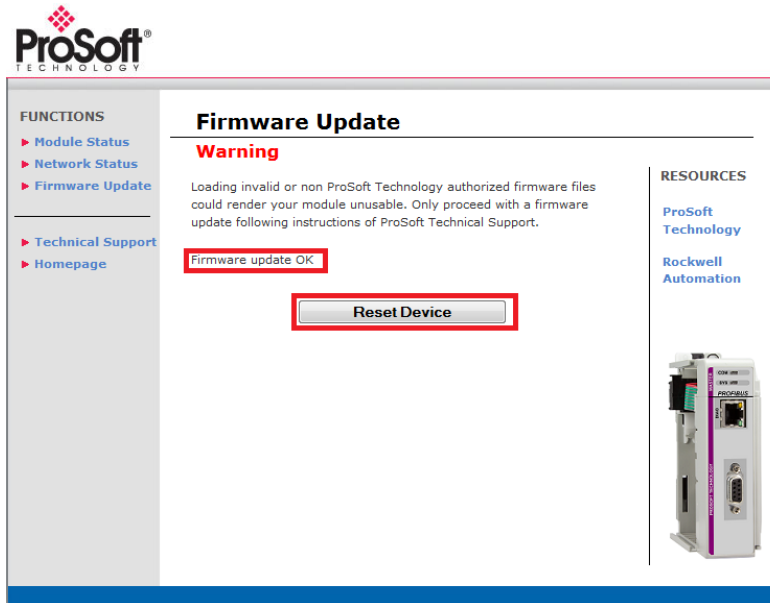

5 To complete the update process, click **RESET DEVICE**.

- Initiating a device reset causes the device reboot. A reboot will **stop all communications** immediately.
- Non-volatile device parameters that have not been saved, such as a temporary IP address, will be lost during the reset.
- Before you initiate a reset, make sure your system is in an idle state and operating under maintenance conditions. This will prevent personal injury or system damage.

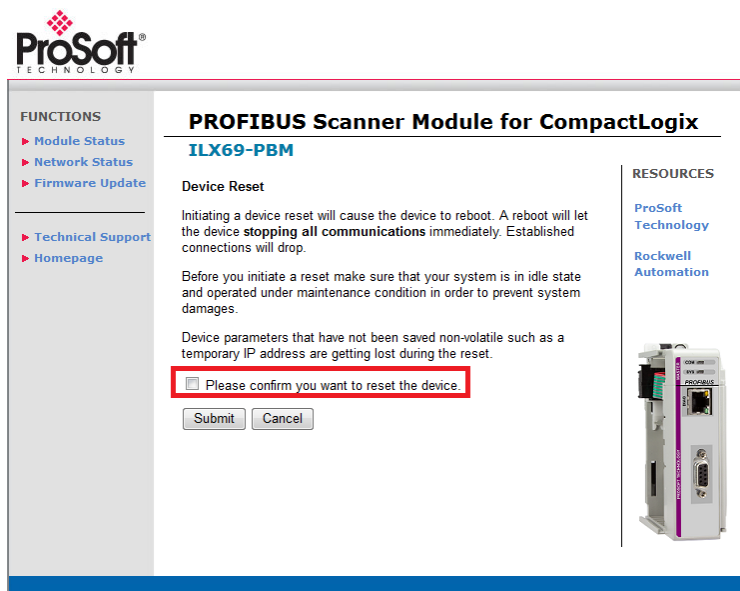

- 6 Check the **PLEASE CONFIRM YOU WANT TO RESET THE DEVICE** box.
- 7 Click **SUBMIT**.

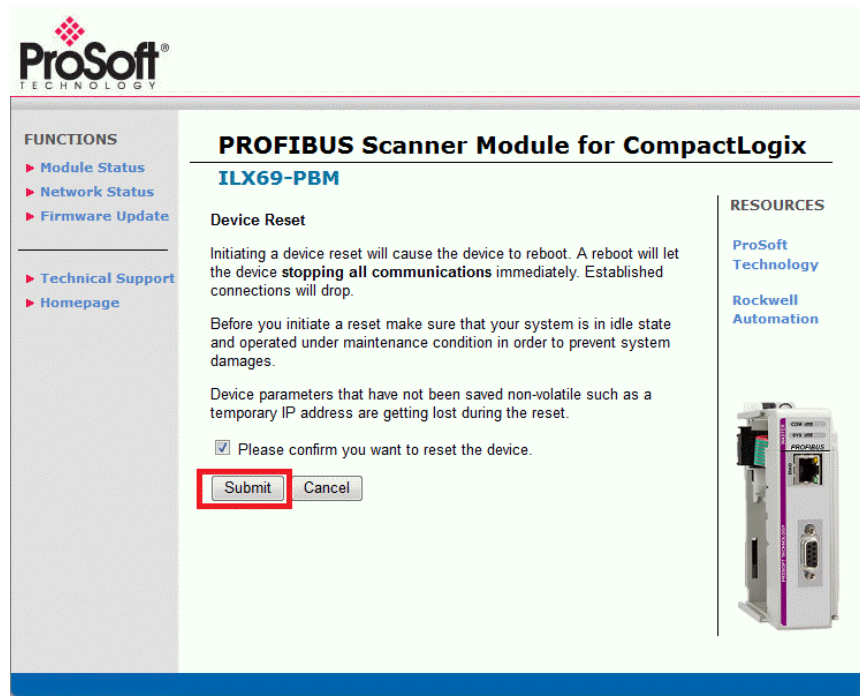

When complete, the following dialog will display:

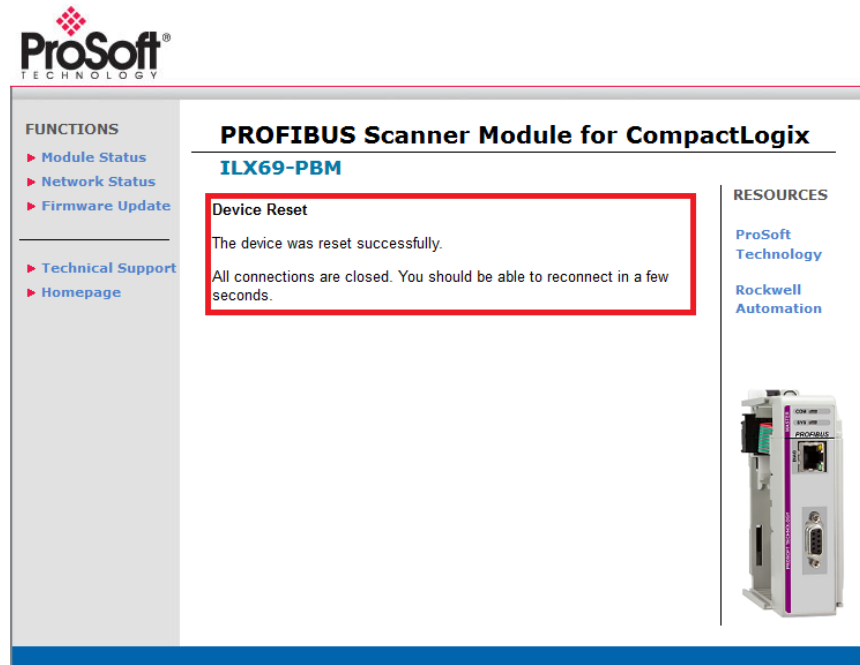













7.2 Hardware LEDs

The following section contains LED descriptions for the CompactLogix™ controller and the ILX69-PBM.

7.2.1 CompactLogix LEDs

The CompactLogix™ PLC LEDs are described below.

LED	Color	State	Description
RUN	 (Green)	On	One or more tasks are running; controller is in Run mode.
	 (Off)	Off	No task(s) running; controller is in Program mode.
FORCE	 (Amber)	Flashing	One or more input or output addresses have been forced to an On or Off state, however the forces have not been enabled.
	 (Amber)	Amber	Forces enabled
	 (Off)	Off	No forces enabled
OK	 (Green)	On	Controller OK
	 (Red)	Flashing	Recoverable controller fault
	 (Red)	On	Non-recoverable controller fault: Cycle power. The OK LED should change to flashing red. If OK LED remains solid red, replace the controller.
	 (Off)	Off	No power applied
I/O	 (Green)	On	Communicating to all devices
	 (Green)	Flashing	One or more devices is not responding
	 (Red)	Flashing	Not communicating to any devices Controller faulted
	 (Off)	Off	No activity; no I/O or communications configured





LED State	Description
On	The indicator is constantly on
Off	The indicator is constantly off
Blinking	The indicator turns on and off cyclically

7.2.2 ILX69-PBM LEDs

The ILX69-PBM LEDs indicate the status information. Each LED has a specific function during Run, configuration download, and error indications.





Communication Status

The ILX69-PBM PROFIBUS DP **COM** LED status is described below.

LED	Color	State	Description
COM	Duo LED red/green		
	 (Green)	On	Communication to all slaves is established
	 (Green)	Flashing cyclic	PROFIBUS is configured, but bus communication is not yet released from the application
	 (Green)	Flashing acyclic	No configuration or faulty configuration
	 (Red)	Flashing cyclic	Communication to at least one slave is disconnected.
	 (Red)	On	Communication to all slaves is disconnected or another serious error has occurred. Redundant Mode: The active master was not found.





PROFIBUS System Status

The **SYS** PROFIBUS network status LED is described below.

LED	Color	State	Description
SYS	Duo LED yellow/green		
	 (Green)	On	Operating system running
	 (Green/Yellow)	Blinking Green/Yellow	Second stage bootloader is waiting for firmware
	 (Yellow)	Static	Bootloader netX (= romloader) is waiting for second stage bootloader
	 (Off)	Off	Power supply for the device is missing or hardware defect

Diagnostic Status

The **DIAG** Ethernet Status LEDs are described below.

LED	Color	State	Description
LINK	LED Green		
	 (Green)	On	The device is linked to the Ethernet network
	 (Off)	Off	The device has no link to the Ethernet network
ACT	LED Yellow		
	 (Yellow)	Flickering (load dependant)	The device is sending/receiving Ethernet frames
	 (Off)	Off	The device is not sending/receiving Ethernet frames

Error Sources and Reasons

This section describes the typical problems and sources of error that come up while commissioning the ILX69-PBM

Behavior	Significance	Typical Reason	Help
CompactLogix™ I/O LED is flashing green	No communication with the ILX69-PBM (or other modules)	- ILX69-PBM slot number in Studio 5000 program does not match with the physical slot of the module - Configured Input / Output size is wrong	- Check ILX69-PBM slot number in Studio 5000 project - Compare configured Input / Output size with required values
ILX69-PBM COM LED is off, SYS LED flashing irregular green	Configuration missing or faulty	No configuration stored	Download a configuration to the ILX69-PBM with ProSoft fdt Configuration Manager
ILX69-PBM COM LED is static green, SYS LED flashing cyclic fast green	Application is not ready	- PLC is not in RUN mode - PLC application has set the NRDY bit - PLC has no I/O communication with the ILX69-PBM	- Apply PLC into RUN Mode. - Check that the PLC application has deleted the NRDY bit. - Check PLC's I/O LED
ILX69-PBM COM LED is static red, SYS LED static green	At least one slave is not in data exchange	- Master configuration does not match with physical bus configuration - Configured slave is not connected on PROFIBUS network or has a problem	- Check PROFIBUS configuration, slave addresses etc. - Use ProSoft fdt Configuration Manager diagnostics to find the wrong slave
ILX69-PBM COM LED is static red, SYS LED flashing cyclic fast green	No communication to any slave	- PROFIBUS cable not connected - No slaves connected - PLC is not in RUN mode	- PROFIBUS wiring - Check if slaves are connected - Check if PROFIBUS configuration matches with physical configuration - Apply PLC into in RUN mode
Slave input data can not be found in Studio 5000 program	Input array mismatch	-Configured input size in Studio 5000 too small -Configured input address table in ProSoft fdt Configuration Manager does not match with PLC program	-Check if the configured input size in Studio 5000 covers the mandatory size of 88 byte status data and in ProSoft fdt Configuration Manager configured PROFIBUS input array -Check if configured Input address table in ProSoft fdt Configuration Manager matches with PLC program

Behavior	Significance	Typical Reason	Help
Outputs are not transferred to slave although PROFIBUS is running	Output array mismatch	-Configured output size in Studio 5000 is too small -Configured output address table in ProSoft fdt Configuration Manager does not match with PLC program	-Check if the configured output size in Studio 5000 covers the mandatory size of 16 byte status data and in ProSoft fdt Configuration Manager configured PROFIBUS output array -Check if configured Output address table in ProSoft fdt Configuration Manager matches with PLC program
ProSoft fdt Configuration Manager download results in error 100	Download not allowed	Configuration download is not allowed while PLC is in RUN mode	Apply PLC into STOP mode

7.3 Troubleshooting

Troubleshooting of the system is done by examining the LEDs on the front panel of the PLC and the LEDs on the front of the ILX69-PBM. The following can help with troubleshooting.

LINK-LED

- Check the LINK LED status to see if a connection to the Ethernet is established. See section Ethernet Status (page 102).

Cable

- Check the pin assignment of each connector on the PROFIBUS cable.
- Check if the bus termination resistors are switched on at each end of the cable, and switched off at all other connectors in between.

ProSoft fdt Configuration Manager

- Check the configuration in the master device and the slave device. The configuration must match.
- With the **Online > Diagnostics** menu, the diagnostics information of the module is displayed using the ILX69-PBM DTM. In the master diagnostics dialog, you can determine the current running state of the ILX69-PBM. In the slave diagnostics dialog, you can determine the current running state of the slave as well as extended diagnostics data.

8 Technical Data

8.1 Technical Data - ILX69-PBM



Note: All technical data can be altered without notice.

ILX69-PBM	Parameter	Value
General	Description	PROFIBUS DP master module
	Function	PROFIBUS DP master slot extension module for Rockwell CompactLogix™ 1769 system which allows the PLC to control data exchange on a PROFIBUS network.
Communication Controller	Type	netX 100 processor
Integrated Memory	RAM	8 MB SDRAM
	FLASH	16 MB serial Flash EPROM
	Memory card	SD and SDHC card. Both types are supported if the card features a SPI interface. The FAT12/16/32 formats are supported. The exFAT format is not supported. Capacity: Max. 4 GByte Refer to section Removable Memory Card (page 20)
	SD Card Connector	e.g. FPS009-2405-0 push/push
Host Interface	1769 Backplane	Rockwell backplane interface: Rockwell Mercury chip for 1769 backplane
PROFIBUS Communication	Supported communication protocol	PROFIBUS DP master
PROFIBUS Interface	Transmission rate	9.6 kBit/s, 19.2 kBit/s, 31.25 kBit/s, 45.45 kBit/s, 93.75 kBit/s, 187.5 kBit/s, 500 kBit/s, 1.5 MBit/s, 3 MBit/s, 6 MBit/s, 12 MBit/s
	Interface Type	RS-485, according EN 50170, refer to section PROFIBUS Interface (page 17)
	Galvanic Isolation	Isolated
	Isolation Voltage	500 VDC (from backplane)
	Connector	D-Sub female Connector, 9 pin
Ethernet Interface (Diagnostics Interface)	Transmission rate	100 MBit/s, 10 MBit/s (depending on loaded firmware)
	Interface Type	100 BASE-TX, 10 BASE-T
	Galvanic Isolation	Isolated
	Isolation Voltage	500 VDC (from backplane)
	Half duplex/Full duplex	Supported (at 100 MBit/s)
	Auto-Negotiation	Supported

	Auto-Crossover	Supported
	Connector	RJ45 Socket
Display	LED Display	<p>COM LED communication status (duo LED)</p> <p>SYS System status LED</p> <p>DIAG yellow, green RJ45 for Ethernet Link and Activity status</p> <p>Refer to section Hardware LEDs (page 101)</p>
Power supply	Supply Voltage	+5 VDC ±5 %, refer to section Power Supply (page 20)
	Maximum Current at 5 V (typically)	570 mA
	Power distance rating	2 slots
	Connector	Backplane
Environmental Conditions	Operating temperature range*	0 °C (32°F) to +60°C (140°F)
	Storage temperature range	-40 °C (-40°F) to +85 °C (185°F)
	Humidity	5% to 95% relative humidity, no condensation permitted
	Environment	For UL compliant usage: The device must be used in a pollution degree 2 environment.
Device	Dimensions (L x W x H)	131.6 x 92.1x 39.3 mm
	Mounting/Installation	Rockwell backplane interface, refer to section ILX69-PBM Hardware Installation (page 24)
	RoHS	Yes
	Weight	152 g
UL Certification (in Preparation)	The device is certified according to UL 508	UL/cUL Class 1 Div 2
PROFIBUS conformance		PROFIBUS PI certification pending
Configuration	Configuration software	ProSoft fdt Configuration Manager

Environmental Specifications

Environmental Specifications Type	Measurements	Value
Emission	Radiated Emission E-Field	DIN EN 61131-2; CISPR 16, EN 55011
	Conducted Emission	DIN EN 61131-2; CISPR16, EN55011
Immunity	Immunity to Electrostatic Discharge (ESD)	DIN EN 61131-2; IEC 61000-4-2
	Immunity to Burst	DIN EN 61131-2; IEC 61000-4-4
	Immunity to Surge	DIN EN 61131-2; IEC 61000-4-5
	Immunity to Radiated Electromagnetic Field	DIN EN 61131-2; IEC 61000-4-3
	Immunity to Conducted RF	DIN EN 61131-2; IEC 61000-4-6
Climate Test	Dry Heat Withstand	DIN EN 61131-2; Clause 6.2, DIN EN 60068; -2-2 Bb
	Cold Withstand	DIN EN 61131-2; Clause 6.2, DIN EN 60068; -2-1 Ab
	Dry Heat Immunity	DIN EN 61131-2; Cl. 12.1.5 / 11.6, DIN EN 60068; -2-2 Bd
	Cold Immunity	DIN EN 61131-2; Cl. 12.1.5 / 11.6, DIN EN 60068; -2-1 Ad
Mechanical Test	Vibration Sinusoidal	DIN EN 61131-2; Clause 6.3.1, DIN EN 60068; -2-6 Fc
	Shock Test	DIN EN 61131-2; Clause 6.3.2, DIN EN 60068; -2-27 Ea

8.2 Technical Data - PROFIBUS

Parameter	Description
Maximum number of supported DPV0/DPV1 slaves	125 slaves
Maximum number of total cyclic input data	5712 bytes (Status information is separately managed)
Maximum number of total cyclic output data	5760 bytes
Maximum number of cyclic input data	244 bytes per slave
Maximum number of cyclic output data	244 bytes per slave
Configuration data maximum	244 bytes per slave
Parameterization data per slave	7 bytes/slave standard parameters 237 bytes/slave application specific parameters
Acyclic communication DPV1	Class 1 Read/Write DPV1 Class 1 Alarm DPV1 Class 2 Initiate/Read/Write/Data transport/Abort
Maximum number of acyclic read/write	240 bytes per slave
Redundancy function	Supported (Requires host application program support)
Baud rate	9.6 kBaud, 19.2 kBaud, 45.45 kBaud, 93.75 kBaud, 187.5 kBaud, 500 kBaud 1.5 MBaud, 3 MBaud, 6 MBaud, 12 Mbaud. Auto-detection mode is not supported.
Data transport layer	PROFIBUS FDL
Limitations	DPV2 isochronous mode and slave-to-slave communication are not supported. The redundancy function is not supported.
Reference to firmware/stack version	V2.6.x.x

9 Annex

9.1 PROFIBUS Functionality

9.1.1 DPV0 Services

PROFIBUS DPV0 services refer to the cyclic data exchange mechanism between a class 1 master and a slave. PROFIBUS DP defines two types of masters:

- A class 1 master handles data communication with slaves assigned to it
- A class 2 master is used for commissioning purposes

In a PROFIBUS message, class 1 masters and slaves transmit up to 244 bytes. Valid station addresses on a PROFIBUS network range from 0 to 126.

Fail Safe Mode

For safety reasons, the ILX69-PBM informs the slaves of its current control status at certain intervals using a "Global Control" message. If the ILX69-PBM goes to Clear Mode, the Fail Safe enabled slaves will switch to a Fail Safe state. Slaves capable of the Fail Safe state can be configured to either to hold the last state of the outputs or set its outputs to "0". Slaves that do not support the Fail Safe state set their outputs to "0".

Global Control

With the Global Control message, the ILX69-PBM can send unsolicited commands like Sync/Unsync, Freeze/Unfreeze and Clear Data to a slave or a group of slaves for synchronization purposes. Group membership is defined during network start-up and in ProSoft fdt Configuration Manager.

Sync and Freeze

Sync and Freeze are optional commands where slaves do not need to support them. The slaves must be able to process the Global Control message. With a Freeze command, the ILX69-PBM prompts a slave or a group of slaves to "freeze" their inputs to the current state. A Sync command causes the current output data to latch at their current state until the next Sync message arrives. Unfreeze and Unsync cancel each corresponding state.

Extended Device Diagnostics

Using diagnostics messages, the slave informs the ILX69-PBM of its current state in a high-priority message. The first 6 bytes of the diagnostics message are comprised of information such as its identity code ("Ident Number") and correct/incorrect configuration. The remaining bytes of this message are referred to as Extended Device Diagnostics, containing information that is specific to the particular slave.

Watchdog

Using the Watchdog functionality, a network slave is able to monitor bus traffic. This ensures that the ILX69-PBM is still active, with process data still being updated. The Watchdog time is configured in ProSoft fdt Configuration Manager and is transmitted from the ILX69-PBM to the slave during the network start-up phase. If the Watchdog timeout has been reached, the slaves go to their Fail Safe state (if supported) or set their outputs to "0".

9.1.2 DPV1 Services

As an addition to cyclic DPV0 services, acyclic services called Read, Write and Alarm were added to PROFIBUS. These services are referred to as DPV1. With DPV1, it is possible to address individual slaves within the network. In addition, DPV1 services allow the transfer of non-time critical data to slaves. DPV1 data exchange takes place after cyclic data exchange in a PROFIBUS network cycle.

Read Request

With a Read Request message, the ILX69-PBM can read data addressed by slot and index within the data range of a slave device. This may take several DPV0 cycles. If the ILX69-PBM discovers a timeout, it aborts both DPV1 and DPV0 communication with the slave. The communication to the slave must be re-established. The ILX69-PBM initiates the Read Request service.

Write Request

With a Write Request message, the ILX69-PBM can write data to a slave, addressed by slot and index. The timeout handling is identical to the Read Request. The ILX69-PBM initiates the Write Request service.

Alarm Indication

DPV1 Alarm handling is an addition to the Device Diagnostics function in a PROFIBUS message. Alarms are reported to the ILX69-PBM as device-specific diagnostics information. The slave initiates an Alarm Indication. Other than Device Diagnostics messages, Alarms must be acknowledged by the ILX69-PBM.

Start/Stop Communication

PROFIBUS communications can be started/stopped by using the "NRDY" (NotReady) Bit. When this bit is set, the communication between the ILX69-PBM and all slaves is stopped. All slaves will clear their outputs and the ILX69-PBM will be in stop mode. This control bit allows the user program to make a controlled start of the communication with the PROFIBUS network.

9.2 Disposal of Electronic Equipment Waste

As a consumer, you are legally obliged to dispose of all electronic equipment waste according to national and local regulations.



Waste Electronic Equipment

- This product must not be treated as household waste.
 - This product must be disposed of at a designated waste electronic equipment collecting point.
-

9.3 References

- [1] PROFIBUS DP Master Protocol API Manual, Revision 19, Hilscher GmbH 2013
- [2] PROFIBUS DP Slave Protocol API Manual, Revision 15, Hilscher GmbH 2013

9.4 Glossary

Baud rate

Data transmission speed of a communication channel or interface.

Boot loader

Program loading the firmware into the memory of a device in order to be executed.

Device Description File

A file containing configuration information about a device being a part of a network that can be read out by the master for system configuration. Device Description Files use various formats that depend on the communication system.

DHCP

Dynamic Host Configuration Protocol. This is a protocol simplifying the configuration of IP networks by automatically assigning IP addresses.

DP

Decentralized Periphery

DPM

Dual-Port Memory

DTM

The Device Type Manager (DTM) is a software module with a graphical user interface for the configuration or for diagnostics of device.

Ethernet

A networking technology used both for office and industrial communication via electrical or optical connections. It provides data transmission with collision control and allows various protocols. As Ethernet is not necessarily capable for real-time application, various real-time extensions have been developed.

FDL

Fieldbus Data Link defines the PROFIBUS communication on layer 2, identical for DP and FMS

FDT

Field Device Tool (FDT) specifies an interface in order to be able to use DTM (Device Type Manager) in different applications of different manufacturers.

Firmware

Software providing the basic functionality of this device. The firmware is stored permanently in the flash memory circuit of the device. It can be updated by a firmware download.

GSD / GSE

Generic **S**tation **D**escription / **E**nglish, Device description file

GSD file

A special kind of Device Description File used by PROFIBUS (GSD = Generic Station Description).

IP Address

Address within IP (the Internet Protocol, part of TCP/IP).

An IP address is an address identifying a device or a computer within a network using the IP protocol. IP addresses are defined as a 32-bit number. For ease of notation, the IP address is divided into four 8 bit numbers which are represented in decimal notation and separated by points:

a.b.c.d

where a.b.c.d are each integer values between 0 and 255.

Example: 192.168.30.15

However, not all combinations are allowed, some are reserved for special purposes.

The IP address 0.0.0.0 is defined as invalid.

PROFIBUS Adapter

PROFIBUS DP slave module

PROFIBUS Scanner

PROFIBUS DP master module

ProSoft fdt Configuration Manager

FDT/DTM based configuration and diagnostics software by ProSoft Technology, Inc.

RJ45

A connector type often used for Ethernet connection. It has been standardized by the Federal Communications Commission of the USA (FCC).

RSLogix™ 5000

PLC design and configuration software from Rockwell Automation

Studio 5000

Logix Designer for PowerFlex Drives from Rockwell Automation

Second Stage Boot Loader (SSL)

Loads an operating systems or parts of it as soon as the boot loader has finished

Watchdog Timer

A watchdog timer provides an internal supervision mechanism of a communication system. It monitors an event occurrence within a given time frame (adjustable) and causes an alarm otherwise. Usually this is accomplished by changing the operational state of the communication system to a safe state.

10 Support, Service & Warranty

10.1 Contacting Technical Support

ProSoft Technology, Inc. is committed to providing the most efficient and effective support possible. Before calling, please gather the following information to assist in expediting this process:

- 1 Product Version Number
- 2 System architecture
- 3 Network details

If the issue is hardware related, we will also need information regarding:

- 1 Module configuration and associated ladder files, if any
- 2 Module operation and any unusual behavior
- 3 Configuration/Debug status information
- 4 LED patterns
- 5 Details about the serial, Ethernet or Fieldbus devices interfaced to the module, if any.

Note: For technical support calls within the United States, ProSoft's 24/7 after-hours phone support is available for urgent plant-down issues.

North America (Corporate Location)	Europe / Middle East / Africa Regional Office
Phone: +1.661.716.5100 info@prosoft-technology.com Languages spoken: English, Spanish REGIONAL TECH SUPPORT support@prosoft-technology.com	Phone: +33.(0)5.34.36.87.20 france@prosoft-technology.com Languages spoken: French, English REGIONAL TECH SUPPORT support.emea@prosoft-technology.com
Latin America Regional Office	Asia Pacific Regional Office
Phone: +52.222.264.1814 latinam@prosoft-technology.com Languages spoken: Spanish, English REGIONAL TECH SUPPORT support.la@prosoft-technology.com	Phone: +60.3.2247.1898 asiapc@prosoft-technology.com Languages spoken: Bahasa, Chinese, English, Japanese, Korean REGIONAL TECH SUPPORT support.ap@prosoft-technology.com

For additional ProSoft Technology contacts in your area, please visit:
<https://www.prosoft-technology.com/About-Us/Contact-Us>.

10.2 Warranty Information

For complete details regarding ProSoft Technology's TERMS & CONDITIONS OF SALE, WARRANTY, SUPPORT, SERVICE AND RETURN MATERIAL AUTHORIZATION INSTRUCTIONS, please see the documents at:
www.prosoft-technology.com/legal