



Where Automation Connects.



ILX34-MBS

Modbus® Serial Module for
CompactLogix™ L1 and Point I/O
Adapters

March 28, 2023

USER MANUAL

Your Feedback Please

We always want you to feel that you made the right decision to use our products. If you have suggestions, comments, compliments or complaints about our products, documentation, or support, please write or call us.

How to Contact Us

ProSoft Technology, Inc.

+1 (661) 716-5100

+1 (661) 716-5101 (Fax)

www.prosoft-technology.com

support@prosoft-technology.com

Copyright © 2023 ProSoft Technology, Inc. All rights reserved.

ILX34-MBS User Manual

For Public Use.

March 28, 2023



For professional users in the European Union

If you wish to discard electrical and electronic equipment (EEE), please contact your dealer or supplier for further information.



Prop 65 Warning – Cancer and Reproductive Harm – www.P65Warnings.ca.gov

Agency Approvals & Certifications

Please visit our website: www.prosoft-technology.com

Contents

Your Feedback Please	2
How to Contact Us.....	2
1 Start Here	4
1.1 ILX34-MBS Overview	4
1.2 Package Contents	4
1.3 System Requirements	4
2 Installing the Adapter	5
2.1 Installing the Mounting Base/Wiring Base Assembly	5
2.2 Installing an I/O Module	6
2.3 Installing the Removable Terminal Block	7
2.4 Removing a Mounting Base.....	8
2.5 Connecting Power	9
2.5.1 CompactLogix L16/L18 Processor Power Connectivity	9
2.5.2 Module Terminations	10
3 Configuration	11
3.1 1734-AENT and 1734-AENTR.....	11
3.2 1734-ACNR.....	11
3.3 1769-L16ER-BB1B, L18ER-BB1B, and L18ERM-BB1B	11
3.4 Sample Configuration Procedure.....	12
3.4.1 Create Module I/O Configuration	15
3.4.2 Importing the Add-On Instruction (AOI)	18
3.4.3 Configuring the ILX34-MBS Modbus Serial Port	22
3.5 Downloading the Sample Program to the Processor.....	26
3.6 Master Command Structure.....	27
3.7 Data Handling	28
3.8 Module Status	29
4 General Features & Specifications	30
4.1 General Specifications	30
4.2 Hardware Specifications	31
4.3 Agency Approvals	31
5 Support, Service & Warranty	32
5.1 Contacting Technical Support.....	32
5.2 Warranty Information	32

1 Start Here

This user manual will help you set up and configure the ILX34-MBS module. You should be somewhat familiar with the following:

- Rockwell Automation® Studio 5000 Logix Designer v21 (for CompactLogix L1 processors) or Rockwell Automation® RSLogix™ 5000 version 16 or greater (for 1734 Point I/O adapters).
- Hardware Installation and Wiring

1.1 ILX34-MBS Overview

The ILX34-MBS is the ideal solution for the many distributed I/O applications where Modbus connectivity can be integrated into an Allen Bradley System. The ILX34-MBSxxx is configured using Rockwell Automation Studio 5000 (CompactLogix L1) and RSLogix 5000 (Point I/O Controllers). The modules work in both the 1734 Point I/O adapters and the CompactLogix L1 processors.

1.2 Package Contents

The following components are included with your ILX34-MBS adapter, and are required for installation and configuration.

Qty.	Part Name	Part Number	Part Description
1	ILX34-MBS Adapter	ILX34-MBS	POINT I/O Adapter

1.3 System Requirements

The ILX34-MBS requires the following minimum hardware and software components:

- Rockwell Automation® processor, with compatible power supply
 - CompactLogix™ L1 Processors or 1734- Point I/O adapters,
- Rockwell Automation RSLogix 5000/Studio 5000 programming software
- Rockwell Automation RSLinx communication software version 2.54 or higher
- Pentium® II 450 MHz minimum. Pentium III 733 MHz (or better) recommended
- Supported operating systems:
 - Microsoft Windows 10
 - Microsoft Windows 7 Professional (32-or 64-bit)
 - Microsoft Windows 2000 Professional with Service Pack 1, 2, or 3
 - Microsoft Windows Server 2003
- 128 Mbytes of RAM minimum, 256 Mbytes of RAM recommended

Note: The Hardware and Operating System requirements in this list are the minimum recommended to install and run software provided by ProSoft Technology. Other third party applications may have different minimum requirements. Refer to the documentation for any third party applications for system requirements.

2 Installing the Adapter

2.1 Installing the Mounting Base/Wiring Base Assembly

The wiring base assembly consists of a mounting base and a removable terminal block. You can install the assembly or just the mounting base. Perform the following to install the base/wiring base assembly:

- 1 Position the mounting base/wiring base assembly vertically above the installed units (adapter, power supply, or existing module).
- 2 Slide the mounting base down allowing the interlocking side pieces to engage the adjacent module or adapter.

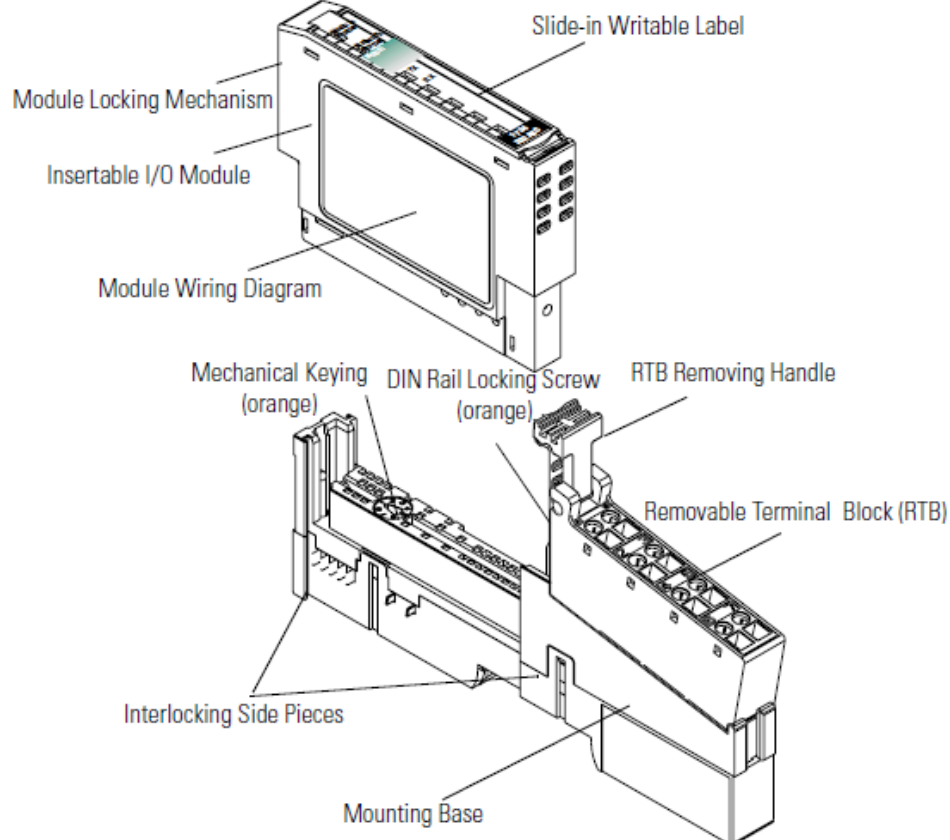

- 3 Press firmly to seat the mounting base on the DIN Rail. The mounting base snaps into place.
- 4 To remove the mounting base from the DIN rail, remove any installed module (and any module immediately to the right) and use a small blade screwdriver to rotate the DIN rail locking screw to a vertical position. This releases the locking mechanism. Lift straight up to remove the mounting base.
- 5 Repeat this procedure for the next mounting base assembly.

2.2 Installing an I/O Module

Make sure that the mounting base is correctly keyed before installing the module into the mounting base. In addition, make sure the mounting base locking screw is positioned horizontal referenced to the base.

Warning: When you insert or remove the module while backplane power is on, an electrical arc can occur. This could cause an explosion in hazardous location installations.

Be sure that power is removed or the area is non-hazardous before proceeding.

- 1 Using a blade screwdriver, rotate the key switch on the mounting base clockwise until the number required for the type of module being installed aligns with the notch in the base.

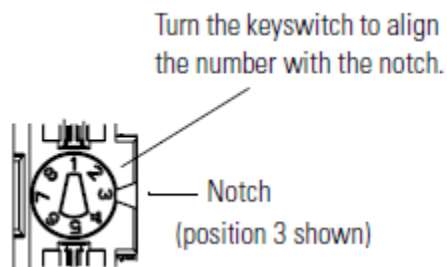

- 2 Make certain the DIN-rail locking screw is in the horizontal position. You cannot insert the module if the locking mechanism is unlocked.

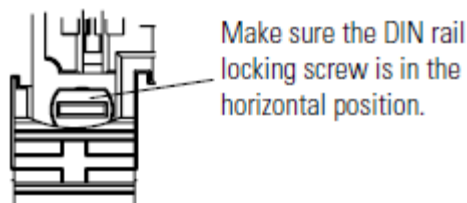

- 3 Insert the module straight down into the mounting base and press to secure. The module locks into place.

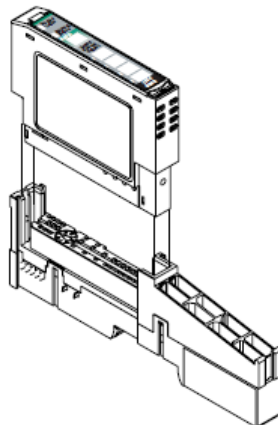

2.3 Installing the Removable Terminal Block

A removable terminal block is supplied with the mounting base assembly. To remove, pull up on the RTB handle. This allows the base to be removed and replaced as necessary without removing any of the wiring. The following instructions show how to reinsert the removable terminal block:

- 1 Insert the RTB end opposite the handle into the base unit. This end has a curved section that engages with the mounting base.

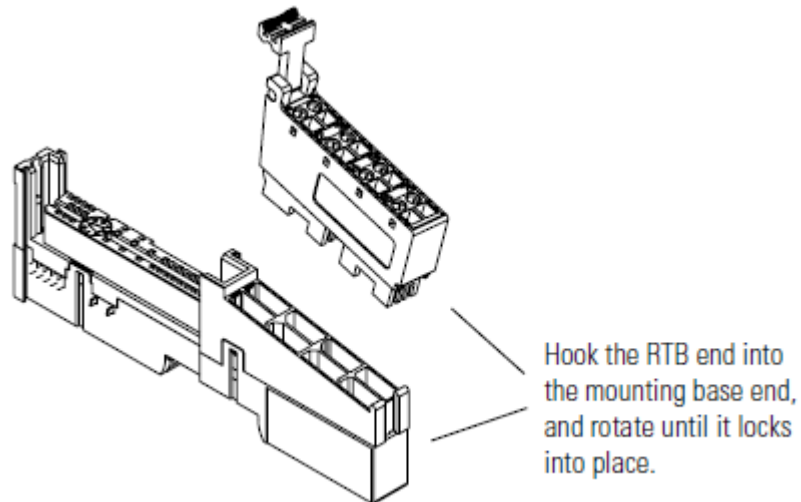

Warning: When you connect or disconnect the Removable Terminal Block (RTB) with the field side power applied, an electrical arc can occur. This could cause an explosion in hazardous location installations.

Be sure that power is removed or the area is non-hazardous before proceeding.

- 2 Rotate the terminal block into the mounting base until it locks itself in place.
- 3 If an I/O module is installed, snap the RTB handle into place on the module.

2.4 Removing a Mounting Base

In order to remove a mounting base, you must remove any installed module, and remove the Removable Terminal Block (if wired).

- 1 Unlatch the RTB handle on the I/O module.
- 2 Pull on the RTB handle to remove the Removable Terminal Block.

Warning: When you connect or disconnect the Removable Terminal Block (RTB) with the field side power applied, an electrical arc can occur. This could cause an explosion in hazardous location installations.

Be sure that power is removed or the area is non-hazardous before proceeding.

- 3 Press on the module lock on the top of the module and pull up on the I/O module to remove from the base.

Warning: When you insert or remove the module while backplane power is on, an electrical arc can occur. This could cause an explosion in a hazardous location.

Be sure that power is removed or the area is non-hazardous before proceeding.

- 4 Remove the module to the right of the base. The interlocking portion of the base sits under the adjacent module.
- 5 Use a small screwdriver to rotate the orange DIN-rail locking screw on the mounting base to a vertical position. This releases the locking mechanism.
- 6 Lift the mounting base and remove.

2.5 Connecting Power

Refer to the appropriate L1Y or Remote Adapter installation guides for adapter configuration instructions.

2.5.1 CompactLogix L16/L18 Processor Power Connectivity

When using an L16/L18 CompactLogix controller, examine the side labeling of the controller to determine what Series it is. It will be listed next to the model number. The device power specification is 10 to 28.8 VDC.

There are two Series of the L16/L18 controllers:

- **Series A** requires two separate NEC Class 2 24V power supplies for the controller power and field power.
- **Series B** uses a single 24V power supply and requires that the field power be jumped from the controller power. The VDC+ should be jumped to the FP+, and the VDC- should be jumped to the FP- as shown below. It uses isolated circuits and does not require a NEC Class 2 rated unit.

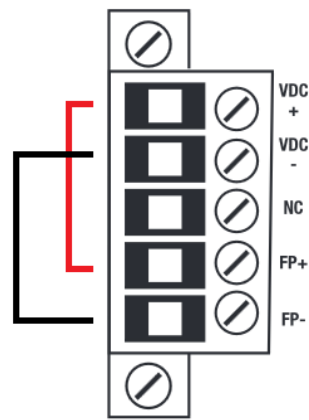

VDC+ to FP+
VDC- to FP-

2.5.2 Module Terminations

The voltage for the serial signal lines are:

Serial	Voltage
RS-232	-15 to +15 VDC
RS-422/485	-7 to +12 VDC

Module Terminations			
Terminal	RS-232	RS-485	RS-422
0	Tx ¹	S ⁺ ¹	Tx ⁺ ¹
1	Rx ²	NC	Rx ⁺ ¹
2	NC	S ⁻ ²	Tx ⁻ ²
3	NC	NC	Rx ⁻ ²
4	NC	NC	NC
5	NC	NC	NC
6	NC	NC	NC
7	SG	SG	SC

1 S+ and Tx+ are transmit from the module

2 S- and Rx- are receive into the module

RS-232		RS-485		RS-422	
0 Tx	1 Rx	0 S+	1 NC	0 Tx+	1 Rx+
2 NC	3 NC	2 S-	3 NC	2 Tx-	3 Rx-
4 NC	5 NC	4 NC	5 NC	4 NC	5 NC
6 NC	7 SG	6 NC	7 SG	6 NC	7 SG

Tx, S+ = Transmit Rx, S- = Receive
 NC = No Connection SG = Signal Ground
 CG = Chassis Ground

Caution: Do not connect 120/240V AC power to this supply.

Warning: If you connect or disconnect wiring while the field-side power is on, an electrical arc can occur. This could cause an explosion in hazardous location installations.

Be sure that power is removed or the area is nonhazardous before proceeding.

3 Configuration

The ILX34-MBS module supports several Point I/O Controllers and Adapters:

- 1734-AENT and AENTR
- 1734-ACNR
- 1769-L16ER-BB1B
- 1769-L18ER-BB1B
- 1769-L18ERM-BB1B

3.1 1734-AENT and 1734-AENTR

To configure the ILX34-MBS module with a 1734-AENT adapter:

- 1 Refer to the 1734-AENT documentation for information on configuring the adapter.
- 2 Refer to **Create Module I/O Configuration** on page 15 to configure the ILX34-MBS module for this adapter.
- 3 Set the chassis size as described in the 1734-AENT/AENTR documentation.

3.2 1734-ACNR

To configure the ILX34-MBS module with a 1734-ACNR adapter:

- 1 Refer to the 1734-ACNR documentation for information on configuring the adapter.
- 2 Refer to **Create Module I/O Configuration** on page 15 to configure the ILX34-MBS module for this adapter.
- 3 Schedule the ControlNet as described in the 1734-ACNR documentation.

3.3 1769-L16ER-BB1B, L18ER-BB1B, and L18ERM-BB1B

Please see the instructions in the following Sample Configuration section.

3.4 Sample Configuration Procedure

Note: The following example procedures are accomplished using Rockwell Automation's Studio 5000 Designer, and also apply to RSLogix. If you are installing this module into a 1734-AENT or ACNR, use RSLogix 5000 v16 or greater and skip to the section entitled Create Module I/O Configuration.

- 1 Open Studio 5000 and click **Create New Project**.
- 2 Expand **CompactLogix 5370 Controller**. Select the appropriate processor from the list:
 - 1769-L16ER-BB1B
 - 1769-L18ER-BB1B
 - 1769-L18ERM-BB1B
- 3 Enter a **Name** for the project.

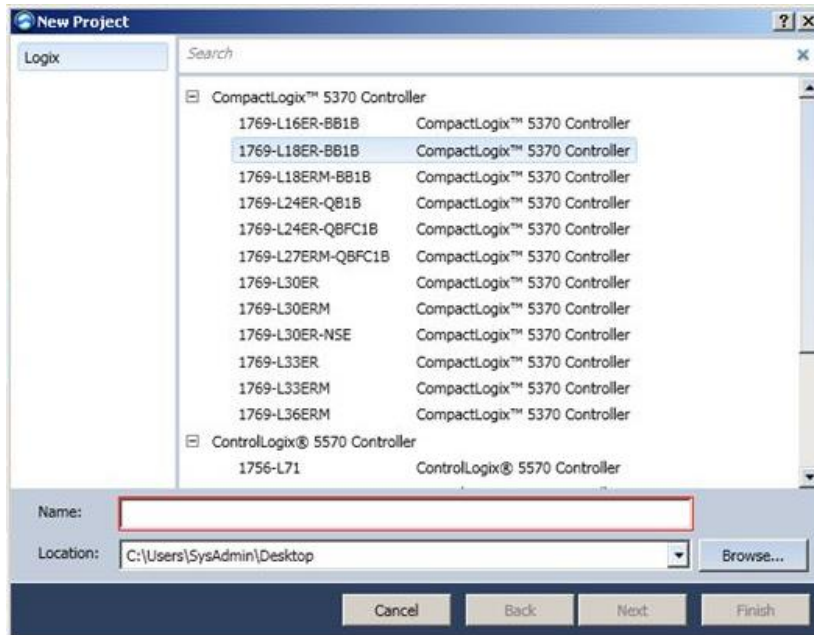

- 4 Click **Next** to open the *Project Configuration* dialog.

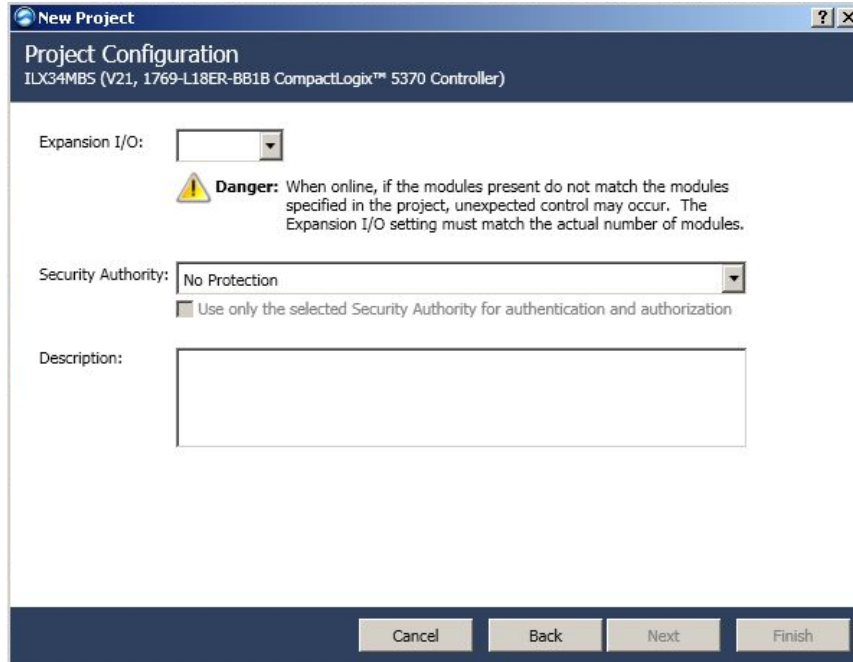

- 5 Select the **Expansion I/O** module number. If the modules present do not match the modules specified in the Project, unexpected control may occur. The *Expansion I/O* setting must match the actual number of modules.

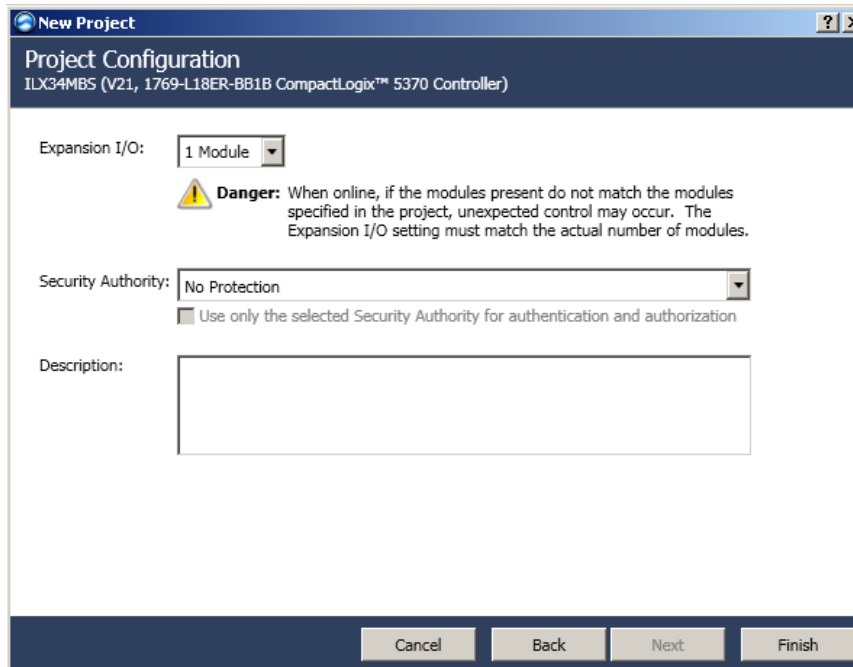

6 Click **Finish**. The following window opens.

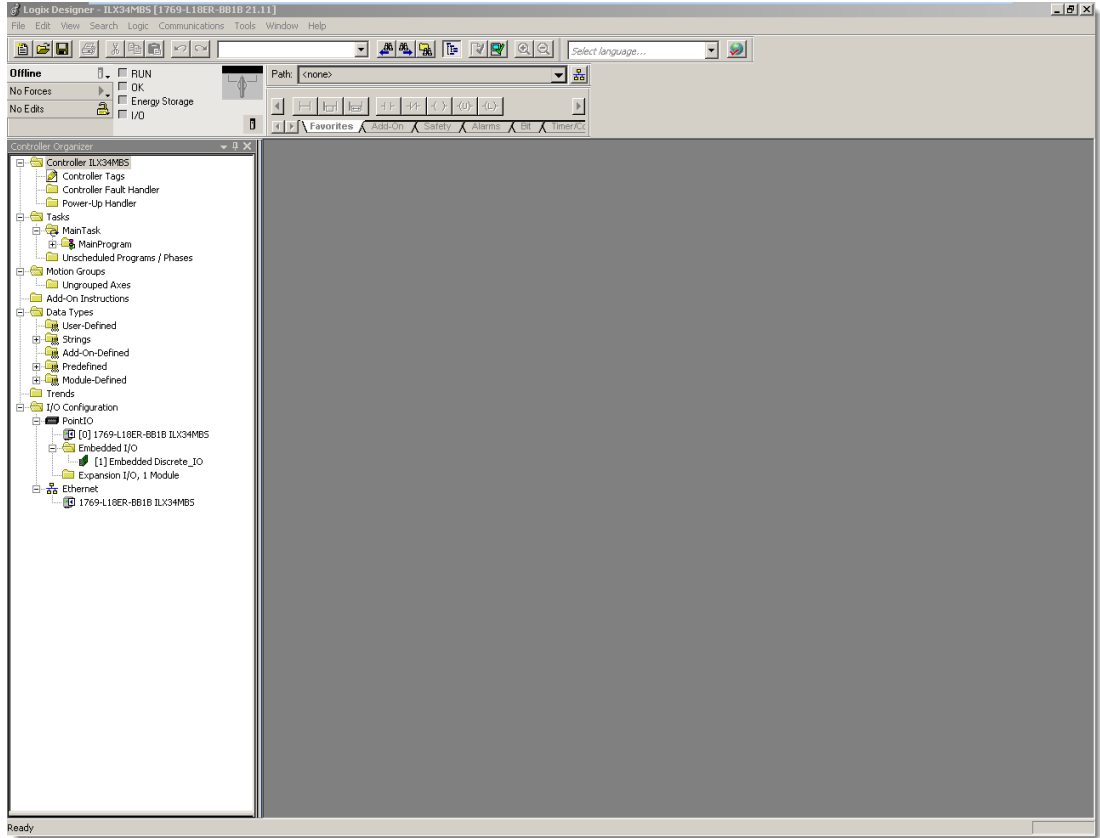

3.4.1 Create Module I/O Configuration

- 1 Right-click on **Expansion I/O** and select **New Module**. The *Select Module Type* dialog opens.

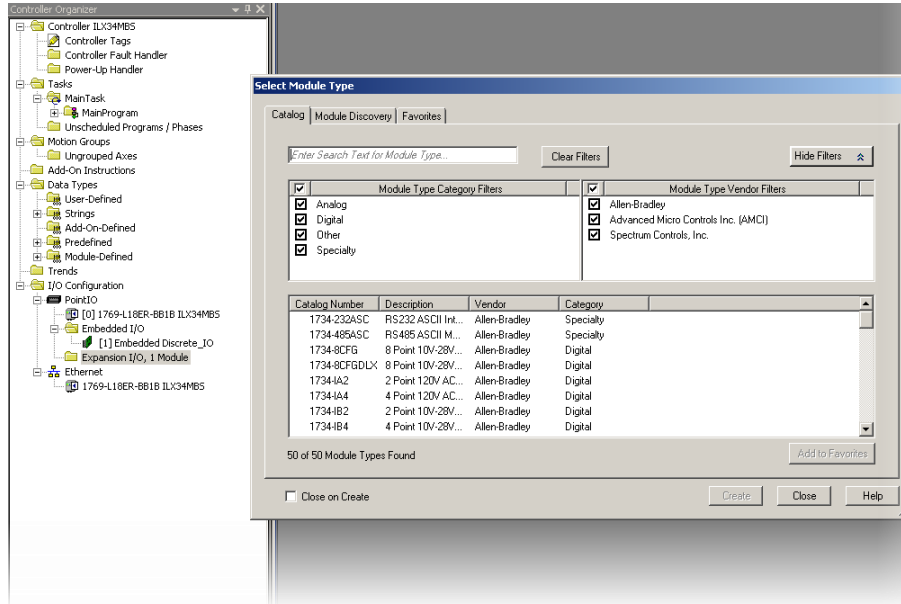

- 2 Locate **1734-MODULE (Generic 1734 Module)** by scrolling the list or using the Search filter.

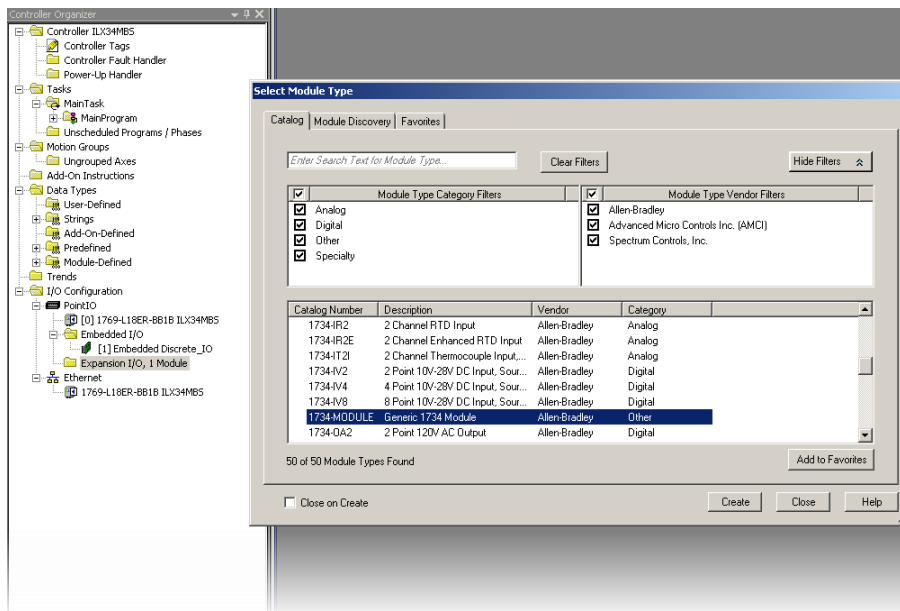

- 3 Click **Create**. The *New Module* dialog opens.

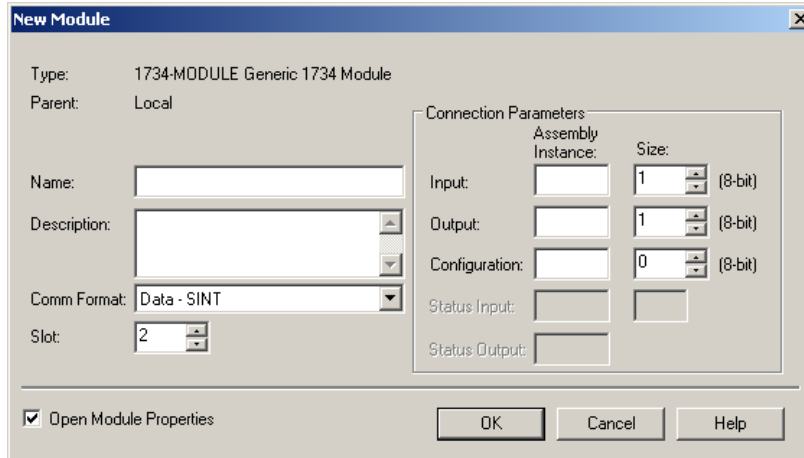

- 4 Enter a **Name** for the module.
- 5 The **Connection Parameters** section is dependent on the application that you are using. There are three different block transfer sizes allowed by the module.

Register/Discrete Max Size per Modbus Message	Input Assembly Instance	Input Size	Output Assembly Instance	Output Size	Configuration Assembly Instance	Configuration Size
8/128	101	34	102	26	103	38
24/384	105	66	106	58	103	38
36/576	107	90	108	82	103	38

- 6 Ensure that the **Comm Format** is set to **Data-SINT** and that the Slot field matches the Slot Number that the module will reside in. Configuration for a Block Transfer size of **36** is shown below.

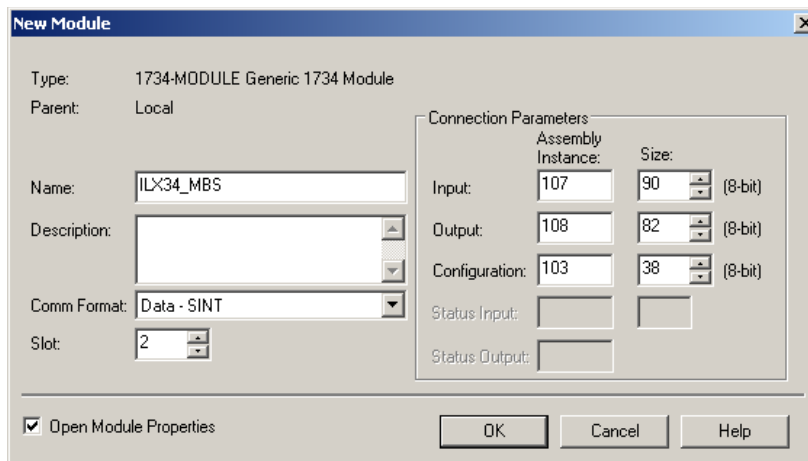

- 7 Click **OK**. The *Module Properties Report* dialog opens.
- 8 Set the **RPI** time to a value larger than 50 ms.

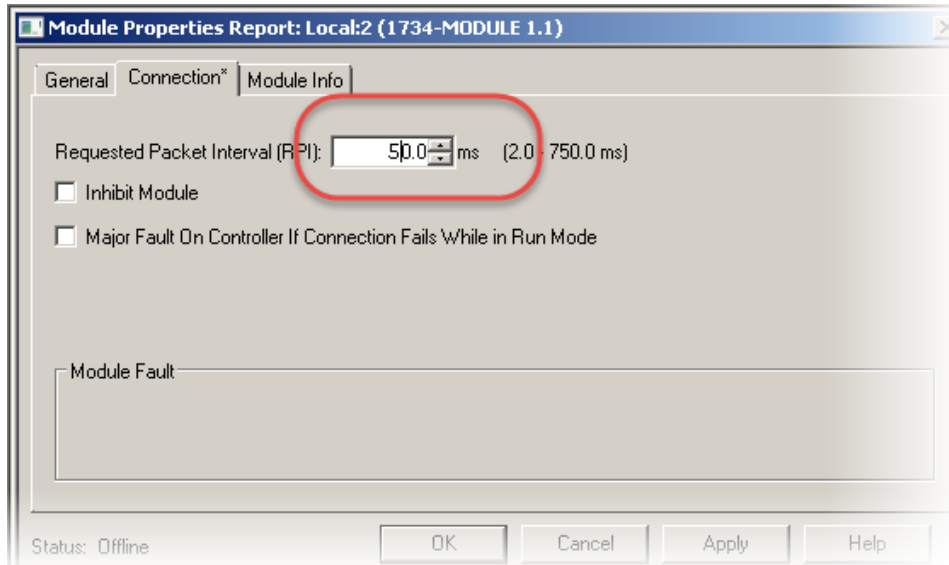

- 9 Click **Apply** then click **OK**. The module now appears under *Expansion Module* in the tree.

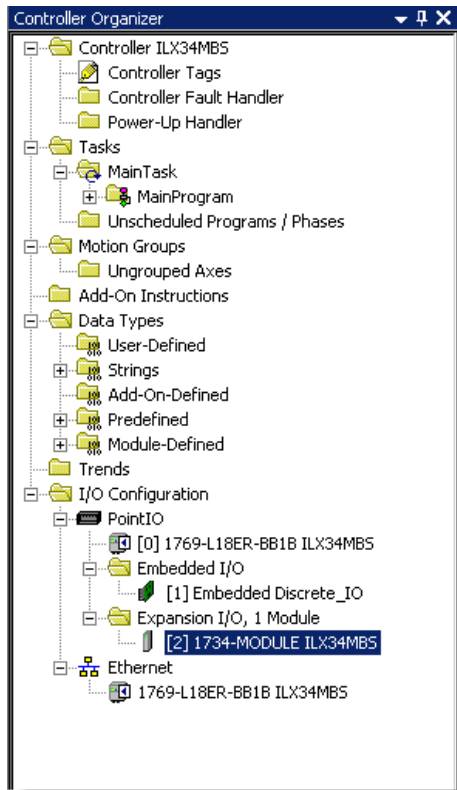

3.4.2 Importing the Add-On Instruction (AOI)

- 1 Under **Tasks**, expand **Main Task > Main Program**.

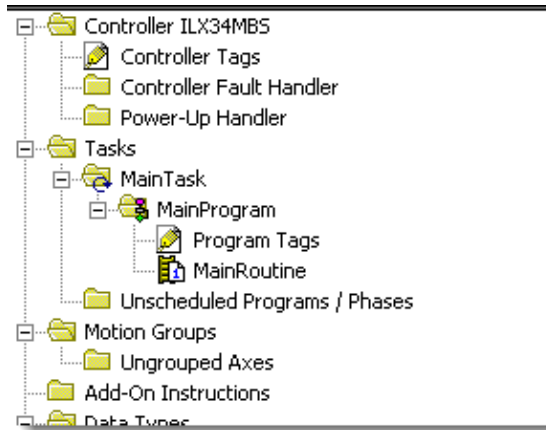

- 2 Double-click on the **Main Routine** icon.

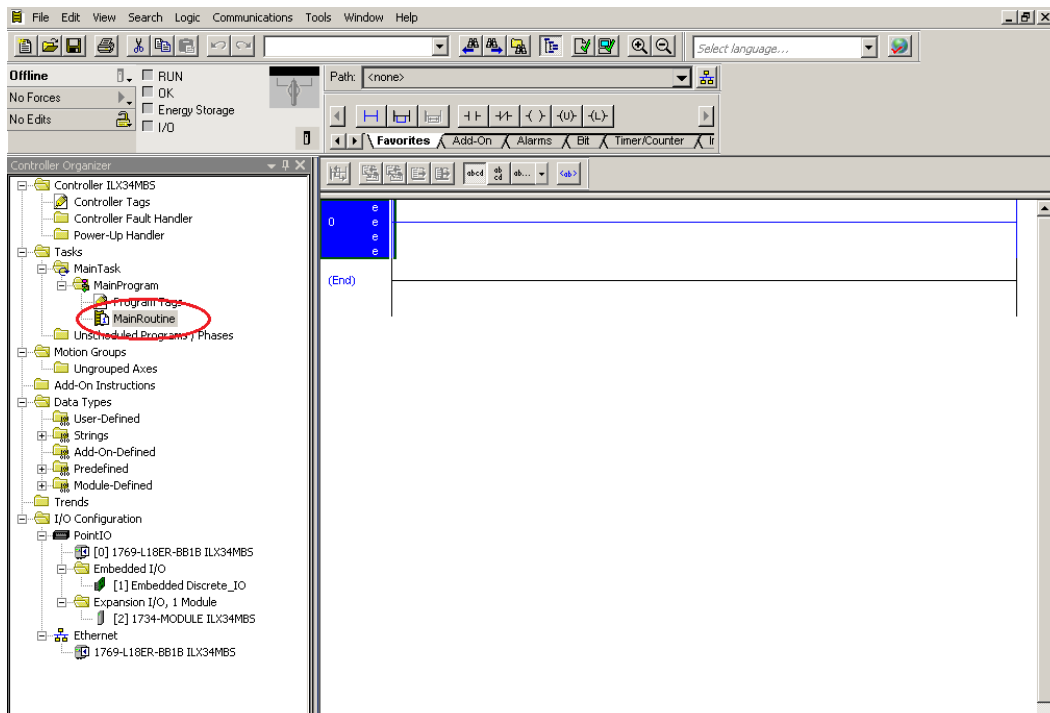

- 3 Right-click anywhere in an empty ladder rung and select **Import Rungs**.

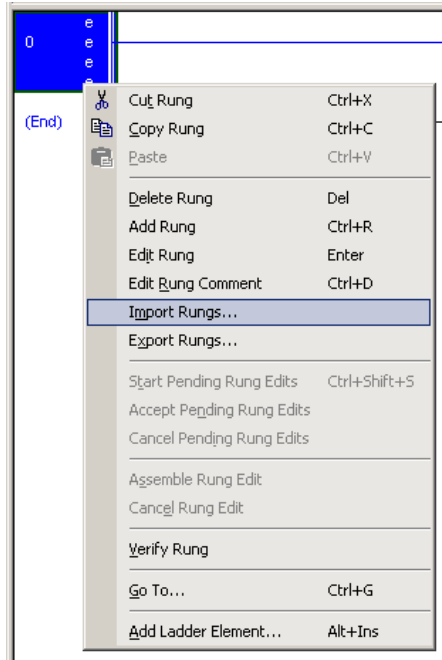

- 4 In the *Import Rung* dialog, navigate to the .L5X file location of the appropriate Add-On rung according to your block transfer size (8, 24, or 36), configured in **Connection Parameters**.
Example: *ILX34-MBS36_AddOn_Rung_v1_1.L5X*
- 5 Click **Import**. The *Import Configuration* dialog opens.

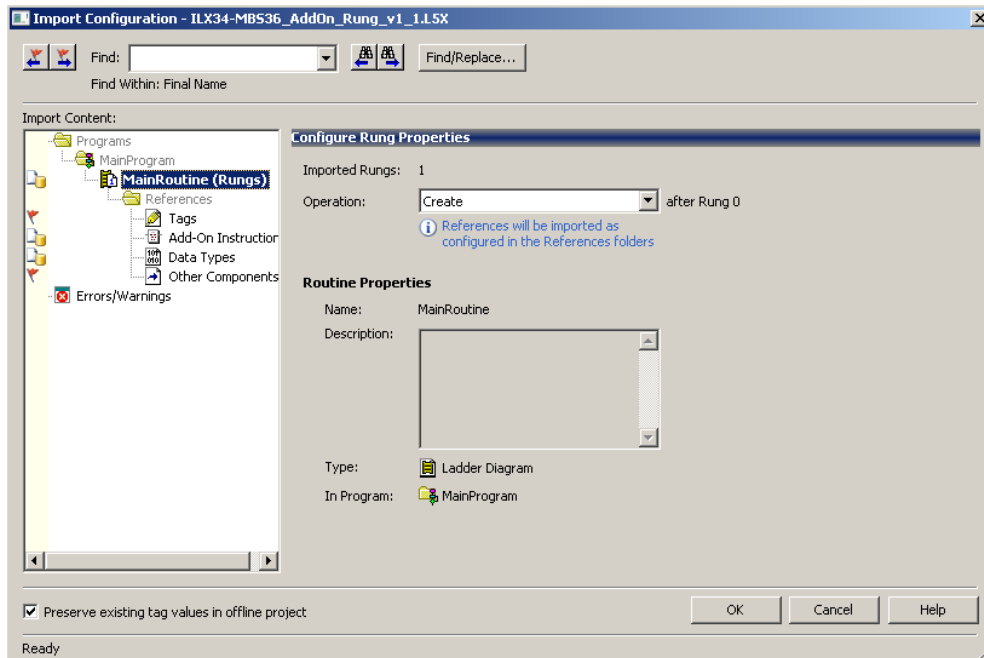

- Click on the **Tags** icon to open the **Configure Tag References** dialog.

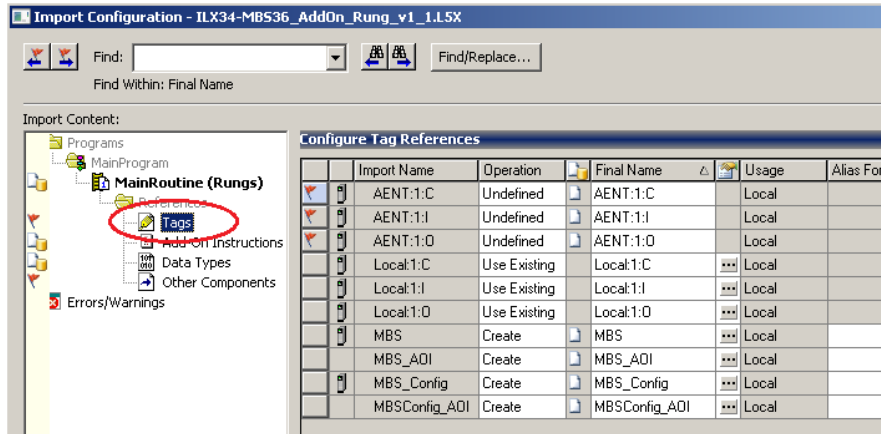

- In the *Final Name* column, edit (map) the 3 imported AENT tag names to reflect the location of the ILX34-MBS in the rack. Also, make sure to enter the correct slot number reference.

Example A: ILX34-MBS in slot 1 of a local rack.

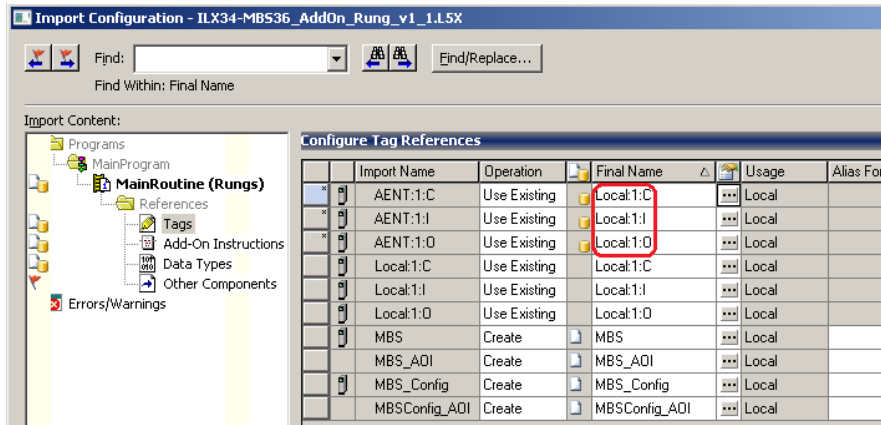

Example B: ILX34-MBS in slot 4 of remote rack *ExRemote* network.

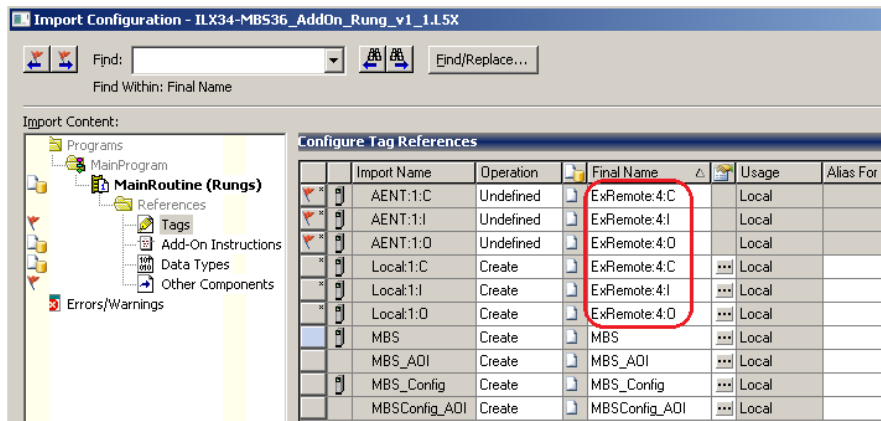

8 Click **OK**. The Add-On rung appears in the *Main Routine*.

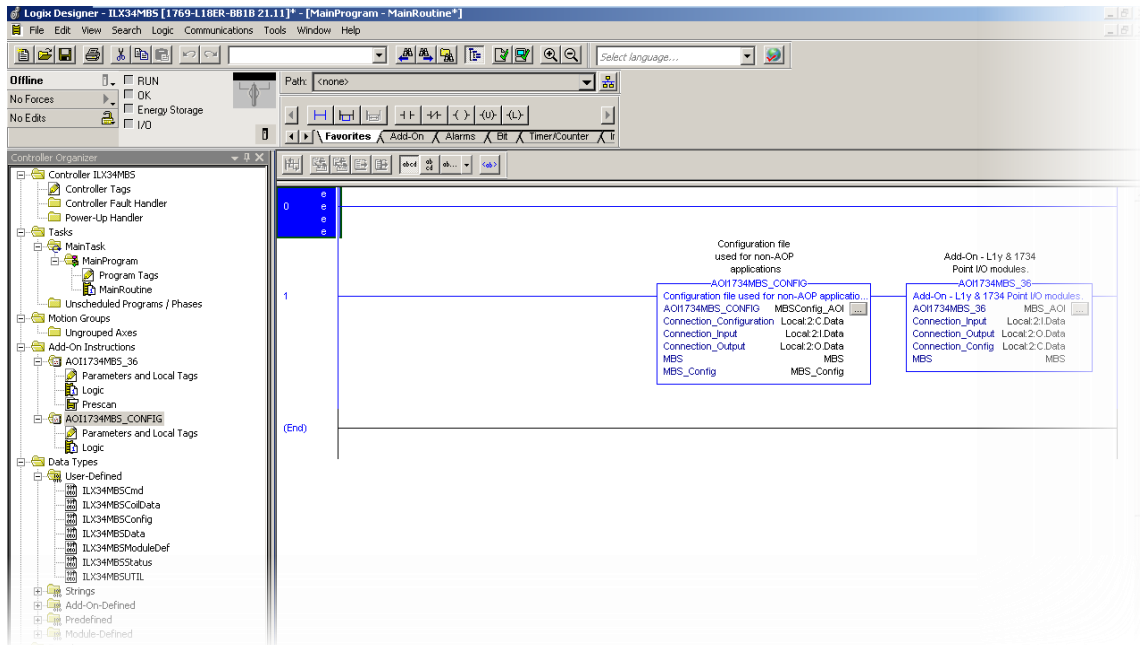

3.4.3 Configuring the ILX34-MBS Modbus Serial Port

- 1 Double-click **Controller Tags** from the *Controller Organizer*.

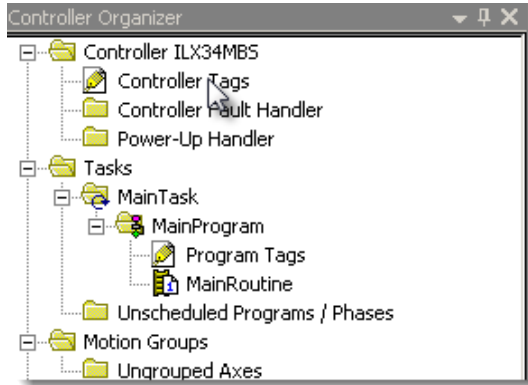

- 2 Expand the **MBS_Config** controller tag.

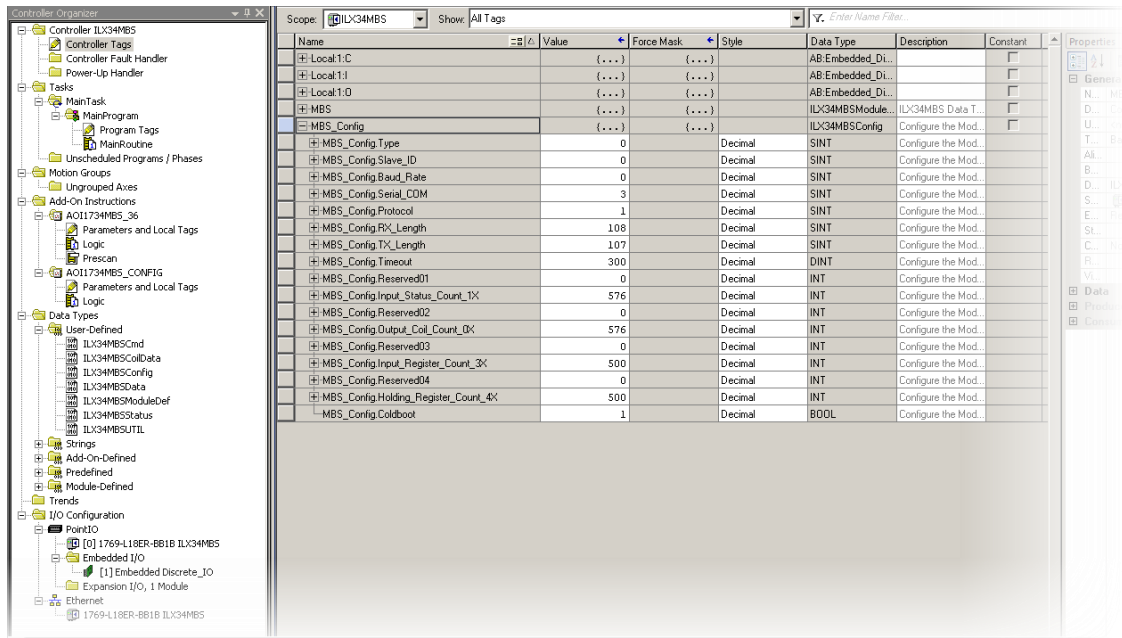

3 Set the following parameters to configure the Serial Port.

Parameter	Description	
Baud Rate	0 = 19200	
	2 = 2400	
	3 = 4800	
	4 = 9600	
	5 = 38400	
Serial Comm	0 = 7N2	4 = 8N2
	1 = 7E1	5 = 8E1
	2 = 7O1	6 = 8O1
	3 = 8N1	
	Protocol	
	0 = ASCII	
	1 = RTU	

3.4.3.1 Master Configuration

The following parameters must be set to use the module as a Master.

Parameter	Description
Type	Set to "0" for Master
Timeout	Timeout in centiseconds. The time that the master waits for a response from the Slave. Value must be greater than 0.

The following example shows the module configured as a *Master, 19200 baud, 8N1 (8 Data bits, No Parity, and 1 Stop Bit) Framing, RTU mode with a three second timeout.*

Name	Value	Force Mask	Style	Data Type	Description	Constant
Local:1:C	{...}	{...}		AB:Embedded_Di...		<input type="checkbox"/>
Local:1:I	{...}	{...}		AB:Embedded_Di...		<input type="checkbox"/>
Local:1:D	{...}	{...}		AB:Embedded_Di...		<input type="checkbox"/>
Local:2:C	{...}	{...}		AB:1734_MODUL...		<input type="checkbox"/>
Local:2:I	{...}	{...}		AB:1734_MODUL...		<input type="checkbox"/>
Local:2:D	{...}	{...}		AB:1734_MODUL...		<input type="checkbox"/>
MBS	{...}	{...}		ILX34MBSModule...	ILX34MBS Data T...	<input type="checkbox"/>
MBS_Config	{...}	{...}		ILX34MBSConfig	Configure the Mod...	<input type="checkbox"/>
MBS_Config.Type	0		Decimal	SINT	Configure the Mod...	
MBS_Config.Slave_ID	0		Decimal	SINT	Configure the Mod...	
MBS_Config.Baud_Rate	0		Decimal	SINT	Configure the Mod...	
MBS_Config.Serial_CDM	3		Decimal	SINT	Configure the Mod...	
MBS_Config.Protocol	RTU		Decimal	SINT	Configure the Mod...	
MBS_Config.RX_Length	108		Decimal	SINT	Configure the Mod...	
MBS_Config.TX_Length	107		Decimal	SINT	Configure the Mod...	
MBS_Config.Timeout	300		Decimal	DINT	Configure the Mod...	
MBS_Config.Reserved01	0		Decimal	INT	Configure the Mod...	
MBS_Config.Input_Status_Count_1X	576		Decimal	INT	Configure the Mod...	
MBS_Config.Reserved02	0		Decimal	INT	Configure the Mod...	
MBS_Config.Output_Coil_Count_0X	576		Decimal	INT	Configure the Mod...	
MBS_Config.Reserved03	0		Decimal	INT	Configure the Mod...	
MBS_Config.Input_Register_Count_3X	500		Decimal	INT	Configure the Mod...	
MBS_Config.Reserved04	0		Decimal	INT	Configure the Mod...	
MBS_Config.Holding_Register_Count_4X	500		Decimal	INT	Configure the Mod...	
MBS_Config.Coldboot	1		Decimal	BOOL	Configure the Mod...	

3.4.3.2 Slave Configuration

The following parameters must be set to use the module as a Slave.

Parameter	Description
Type	Set to "1" for Slave.
Slave ID	1 to 255. Set this to the desired Slave ID that the Master is attempting to access.

The 'Count' parameters determine that maximum address that the Master can access for the ILX34-MBS. The default values represent the max addresses allowed for the provided Add-On instruction. Valid ranges are: 00001 to 00576, 10001 to 10576, 30001 to 30501 and 40001 to 40501.

Coldboot Bit - If parameters change after initial configuration, use the Coldboot bit to initiate the changes.

3.5 Downloading the Sample Program to the Processor

Note: The key switch on the front of the ControlLogix processor must be in the **REM** or **Program** position.

- 1 If you are not already online with the processor, open the *Communications* menu, and then choose **Download**. You do not have to download through the processor's serial port. You may download through any network connection.
- 2 When communication is established, Studio 5000 (or RSLogix 5000) opens a configuration dialog box. Click the **Download** button to transfer the sample program to the processor.

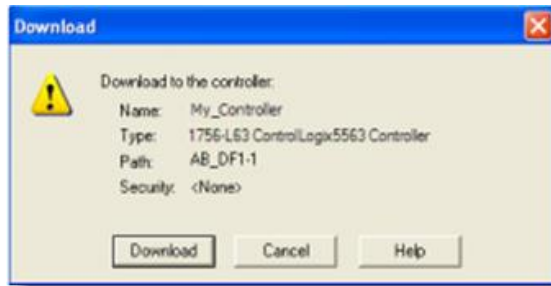

- 3 Studio 5000 (or RSLogix 5000) compiles the program and transfers it to the processor. This process may take a few minutes.
- 4 When the download completes, the configuration program opens another Confirmation dialog box. If the key switch is in the **REM** position, click **OK** to switch the processor from **PROGRAM** mode to **RUN** mode.

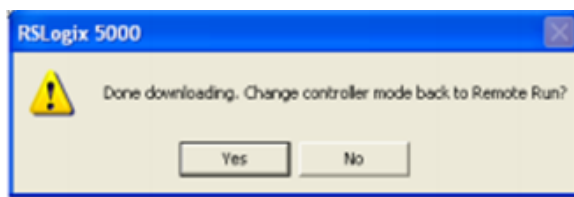

Note: If you receive an error message during these steps, refer to the Rockwell Automation documentation to interpret and correct the error.

3.6 Master Command Structure

[-] MBS.MASTERCMD[0]	{...}
[+] MBS.MASTERCMD[0].Enable	0
[+] MBS.MASTERCMD[0].Node	0
[+] MBS.MASTERCMD[0].Function	0
[+] MBS.MASTERCMD[0].DeviceAddress	0
[+] MBS.MASTERCMD[0].Count	0
[+] MBS.MASTERCMD[0].InternalAddress	0
[+] MBS.MASTERCMD[0].PollInterval	0
[+] MBS.MASTERCMD[0].Swap	0
[-] MBS.MASTERCMD[0].Trigger	0

Parameter	Description
Enable	0 = Disable 1 = Enable the Command: Polling and Trigger allowed. 2 = Enable the Command: Only Trigger allowed.
Node	Node address of the target device on the network (1 to 255).
Function	Function code for the command. 1, 2, 3, 4, 5, 6, 15 and 16 allowed for Master and Slave. 8 allowed for Slave only.
DeviceAddress	Address in remote device associated with the command (0 to 65535).
Count	Number of points associated with the command.
InternalAddress	PLC Tag Internal address associated with the command.
PollInterval	Minimum number of milliseconds between issuance of command (0 to 2,147,483,647).
Swap	0 = None. No change is made in byte ordering. 1 = Words – The words are swapped. 2 = Words & Bytes – The words are swapped, and then the bytes in each word are swapped. 3 = Bytes – The bytes in each word are swapped. The words should be swapped only when using an even number of words.
Trigger	1 = Trigger the message. Can be triggered anytime the command is enabled.

3.7 Data Handling

The following PLC data tags are used for the Master and Slave. For the Master, the tags represent the module's internal addresses. For the Slave, the tags represent the addresses accessed by a remote Master.

[-] MBS.DATA	{...}	{...}		ILX34MBSData
[+] MBS.DATA.InputBit	{...}	{...}	Decimal	BOOL[576]
[+] MBS.DATA.InputRegister	{...}	{...}	Decimal	INT[500]
[+] MBS.DATA.OutputBit	{...}	{...}	Decimal	BOOL[576]
[+] MBS.DATA.OutputRegister	{...}	{...}	Decimal	INT[500]

Parameter	Description
InputBit	Incoming discreet data for address ranges 0x and 1x from other devices. Functions 5 and 15 when device is configured as a Slave. Functions 1 and 2 when configured as a Master.
InputRegister	Incoming register data for address ranges 3x and 4x from other devices. Functions 6 and 16 when device is configured as a Slave. Functions 3 and 4 when configured as a Master.
OutputBit	Outgoing discreet data for address ranges 0x and 1x from other devices. Functions 1 and 2 when device is configured as a Slave. Functions 5 and 15 when configured as a Master.
OutputRegister	Outgoing register data for address ranges 3x and 4x from other devices. Functions 3 and 4 when device is configured as a Slave. Functions 6 and 16 when configured as a Master.

3.8 Module Status

[-] MBS.STATUS	{...}
[+] MBS.STATUS.Module	0
[+] MBS.STATUS.RXCnt	0
[+] MBS.STATUS.TXCnt	0
[+] MBS.STATUS.ErrorCnt	0
[-] MBS.STATUS.CmdError	{...}
[+] MBS.STATUS.CmdError[0]	0
[+] MBS.STATUS.CmdError[1]	0
[+] MBS.STATUS.CmdError[2]	0
[+] MBS.STATUS.CmdError[3]	0
[+] MBS.STATUS.CmdError[4]	0
[+] MBS.STATUS.CmdError[5]	0
[+] MBS.STATUS.CmdError[6]	0
[+] MBS.STATUS.CmdError[7]	0
[+] MBS.STATUS.CmdError[8]	0
[+] MBS.STATUS.CmdError[9]	0
[+] MBS.STATUS.CmdError[10]	0
[+] MBS.STATUS.CmdError[11]	0

Parameter	Description
Module	Module Status 1 = Ready for Command 2 = Processing Command 3 = Waiting for Response 4 = Processing Response
RXCnt	Number of messages received
TXCnt	Number of messages transmitted
ErrorCnt	Number of errors
CmdError [x]	The error represented for MBS.MASTERCMD[x]. 1 = Invalid Function 2 = Invalid Address 3 = Invalid Data 20 = Checksum Error 21 = Modbus Invalid Message 22 = Modbus Timeout 26 = Float Word Swap Uneven Word Count -47 = Parity Error

4 General Features & Specifications

- Add-On instruction creates UDTs, providing logical definitions for I/O, status, and control data
- Diagnostic data available in RSLogix 5000/Studio 5000 controller tags, allowing decisions to be made based upon node health
- Module configuration is backed up in the CompactLogix project (.ACD file)
- Serial port enable/disabled through ladder logic
- Supports up to 1000 words of data
- Supports up to 30 Modbus commands and up to 36 words per command
- The Serial Port can be configured as a Modbus Master or Modbus Slave device
- Suitable for SCADA and field device interface applications

4.1 General Specifications

Specification	Description
Configuration Environment	RSLogix 5000 / Studio 5000
Max Modbus Command Size	Modbus command sizes are limited to 8, 16, and 36 words per command, depending on AOI selected
Max Modbus Commands	30
Communication Parameters	Baud Rate: 2400, 4800, 9600, 19200, 38400 baud Stop Bits: 1 or 2 Data Size: 7 or 8 bits Parity: None, Even, Odd
Modbus Modes	RTU mode (8-bit data size only) ASCII mode with LRC error checking
Node Address	1 to 247
Supported Modbus Function Codes:	1: Read Coil Status 2: Read Input Status 3: Read Holding Registers 4: Read Input Registers 5: Force (Write) Single Coil 6: Preset (Write) Single Holding Register 8: Diagnostics (Slave Only. Responds to Sub-function 00) 15: Force (Write) Multiple Coils 16: Preset (Write) Multiple Holding Registers

4.2 Hardware Specifications

Specification	Description
Power Supply	10 to 28.8 VDC (Two 24V power supplies needed if using a Series A L16/L18 controller)
Pointbus Current	75 mA @ 5 VDC
Serial Line Voltages	RS-232: -15 to +15 VDC RS-422/485: -7 to +12 VDC
Number of Inputs	1 full duplex
Module Location	1734-TB or -TBS wiring base assembly (not included) 1734-TOP or -TOPS
LED Indicators	1 green/red module status indicator 1 green/red network status indicator 2 green TXD, RXD status indicators
Operating Temperature	32°F to +131°F (0°C to +55°C)
Storage Temperature	32°F to +131°F (0°C to +55°C)
Relative Humidity	5% to 95% RH with no condensation
Dimensions (H x W x L)	2.21 x 0.47 x 2.97 in 56 x 12 x 75.5 mm
Shock	30g Peak acceleration (operating) 50g Peak acceleration (non-operating)
Vibration	Tested 5g @ 10 to 500 Hz
ESD Immunity	6 kV contact discharges 8 kV air discharges

4.3 Agency Approvals

Please visit our website: www.prosoft-technology.com

5 Support, Service & Warranty

5.1 Contacting Technical Support

ProSoft Technology, Inc. is committed to providing the most efficient and effective support possible. Before calling, please gather the following information to assist in expediting this process:

- 1 Product Version Number
- 2 System architecture
- 3 Network details

If the issue is hardware related, we will also need information regarding:

- 1 Module configuration and associated ladder files, if any
- 2 Module operation and any unusual behavior
- 3 Configuration/Debug status information
- 4 LED patterns
- 5 Details about the interfaced serial, Ethernet or Fieldbus devices

Note: For technical support calls within the United States, ProSoft Technology's 24/7 after-hours phone support is available for urgent plant-down issues.

North America (Corporate Location) Phone: +1.661.716.5100 info@prosoft-technology.com Languages spoken: English, Spanish REGIONAL TECH SUPPORT support@prosoft-technology.com	Europe / Middle East / Africa Regional Office Phone: +33.(0)5.34.36.87.20 france@prosoft-technology.com Languages spoken: French, English REGIONAL TECH SUPPORT support.emea@prosoft-technology.com
Latin America Regional Office Phone: +52.222.264.1814 latinam@prosoft-technology.com Languages spoken: Spanish, English REGIONAL TECH SUPPORT support.la@prosoft-technology.com	Asia Pacific Regional Office Phone: +60.3.2247.1898 asiapc@prosoft-technology.com Languages spoken: Bahasa, Chinese, English, Japanese, Korean REGIONAL TECH SUPPORT support.ap@prosoft-technology.com

For additional ProSoft Technology contacts in your area, please visit:

www.prosoft-technology.com/About-Us/Contact-Us.

5.2 Warranty Information

For complete details regarding ProSoft Technology's TERMS & CONDITIONS OF SALE, WARRANTY, SUPPORT, SERVICE AND RETURN MATERIAL AUTHORIZATION INSTRUCTIONS, please see the documents at:

www.prosoft-technology/legal