



104C Version 3

ProLinX Gateway

IEC 60870-5-104 Client (Firmware v3.xx)

August 04, 2011

Your Feedback Please

We always want you to feel that you made the right decision to use our products. If you have suggestions, comments, compliments or complaints about our products, documentation, or support, please write or call us.

How to Contact Us

ProSoft Technology

5201 Truxtun Ave., 3rd Floor

Bakersfield, CA 93309

+1 (661) 716-5100

+1 (661) 716-5101 (Fax)

www.prosoft-technology.com

support@prosoft-technology.com

Copyright © 2011 ProSoft Technology, Inc., all rights reserved.

104C Version 3 Protocol Manual

August 04, 2011

ProSoft Technology[®], ProLinx[®], inRAx[®], ProTalk[®], and RadioLinx[®] are Registered Trademarks of ProSoft Technology, Inc. All other brand or product names are or may be trademarks of, and are used to identify products and services of, their respective owners.

ProSoft Technology[®] Product Documentation

In an effort to conserve paper, ProSoft Technology no longer includes printed manuals with our product shipments. User Manuals, Datasheets, Sample Ladder Files, and Configuration Files are provided on the enclosed CD-ROM in Adobe[®] Acrobat Reader file format (.PDFs). These product documentation files may also be freely downloaded from our web site: www.prosoft-technology.com

Important Installation Instructions

Power, Input, and Output (I/O) wiring must be in accordance with Class I, Division 2 wiring methods, Article 501-4 (b) of the National Electrical Code, NFPA 70 for installation in the U.S., or as specified in Section 18-1J2 of the Canadian Electrical Code for installations in Canada, and in accordance with the authority having jurisdiction. The following warnings must be heeded:

WARNING - EXPLOSION HAZARD - SUBSTITUTION OF COMPONENTS MAY IMPAIR SUITABILITY FOR CLASS I, DIV. 2;

WARNING - EXPLOSION HAZARD - WHEN IN HAZARDOUS LOCATIONS, TURN OFF POWER BEFORE REPLACING OR WIRING MODULES

WARNING - EXPLOSION HAZARD - DO NOT DISCONNECT EQUIPMENT UNLESS POWER HAS BEEN SWITCHED OFF OR THE AREA IS KNOWN TO BE NON-HAZARDOUS.
THIS DEVICE SHALL BE POWERED BY CLASS 2 OUTPUTS ONLY.

ProLinx® Products Warnings

WARNING – EXPLOSION HAZARD – DO NOT DISCONNECT EQUIPMENT UNLESS POWER HAS BEEN SWITCHED OFF OR THE AREA IS KNOWN TO BE NON-HAZARDOUS.

AVERTISSEMENT – RISQUE D'EXPLOSION – AVANT DE DÉCONNECTER L'EQUIPMENT, COUPER LE COURANT OU S'ASSURER QUE L'EMPLACEMENT EST DÉSIGNÉ NON DANGEREUX.

ProLinx Gateways with Ethernet Ports

Series C ProLinx™ Gateways with Ethernet ports do **NOT** include the HTML Web Server. The HTML Web Server must be ordered as an option. This option requires a factory-installed hardware addition. The HTML Web Server now supports:

- 8 MB file storage for HTML files and associated graphics files (previously limited to 384K)
- 32K maximum HTML page size (previously limited to 16K)

To upgrade a previously purchased Series C model

Contact your ProSoft Technology distributor to order the upgrade and obtain a Returned Merchandise Authorization (RMA) to return the unit to ProSoft Technology.

To order a ProLinx Plus gateway with the -WEB option

Add **-WEB** to the standard ProLinx part number. For example, **5201-MNET-MCM-WEB**.

Markings

Label Markings

<cULus>

E183151

Class I Div 2

Groups A,B,C,D T6

-30 °C ≤ Ta ≤ 60 °C

<Ex>

II 3 G

Ex nA IIC T4

-20 °C ≤ Ta ≤ 50 °C

II – Equipment intended for above ground use (not for use in mines).

3 – Category 3 equipment, investigated for normal operation only.

G – Equipment protected against explosive gasses.

Contents

Your Feedback Please	2
How to Contact Us	2
ProSoft Technology® Product Documentation	2
Important Installation Instructions	3
ProLinX® Products Warnings.....	3
ProLinX Gateways with Ethernet Ports	3
To upgrade a previously purchased Series C model.....	3
To order a ProLinX Plus gateway with the -WEB option.....	3
Markings.....	4

Guide to the 104C Module Protocol Manual 9

1 Start Here 11

1.1	ProLinX Reference Guide	12
1.2	Installing ProSoft Configuration Builder Software	13
1.2.1	Using the Online Help	13

2 Configuring the Gateway 15

2.1	IEC 60870-5-104 Client Section.....	16
2.1.1	[SNTP CLIENT]	17
2.1.2	[IEC-870-5-104].....	19
2.1.3	[IEC-60870-5-104 Client x].....	21
2.1.4	[IEC-60870-5-104 Client x Sector x] Parameters.....	24
2.1.5	[IEC-60870-5-104 Client x Sector y]	26
2.1.6	[IEC-60870-5-104 Client Commands]	28
2.2	Using the CommonNet Data Map	35
2.2.1	From Address	36
2.2.2	To Address	36
2.2.3	Register Count	36
2.2.4	Swap Code	37
2.2.5	Delay Preset	38
2.3	Downloading a File from PC to the Module.....	39
2.4	Creating Optional Comment Entries	40
2.5	Printing a Configuration File	41

3 IEC-60870-5-104 Protocol Implementation 43

3.1	Module Address	44
3.1.1	IP Address	44
3.2	Monitor Direction and Control Direction: Information Object Definition	46
3.3	Using Monitor Points	49
3.3.1	Monitor Information Objects Addressing	49
3.4	Using Control (Command) Information Objects	57
3.4.1	Control Information Objects Addressing	58
3.4.2	TESTFR Requests	64

4	Mailbox Feature (x201-DFNT-104C)	67
4.1	User Constructed Command Mailbox (9901)	70
4.2	Command Control Block Mailbox (9902)	72
4.3	Event Messages from Outstations Mailbox (9903)	73
4.4	General Gateway Status Mailbox (9250)	76
4.5	Client X Status Data Mailbox (9251)	78
4.6	Command List Error Data Mailbox (9950)	81
4.7	Get Gateway Time Mailbox (9970)	83
4.8	Set Gateway Time Mailbox (9971)	85
4.9	Reset Status Data Mailbox (9997)	87
4.10	Coldboot Mailbox (9998/9999)	88
5	Diagnostics and Troubleshooting	91
5.1	Ethernet LED Indicators	92
5.2	Using ProSoft Configuration Builder (PCB) for Diagnostics	93
5.2.1	Required Hardware	93
5.2.2	Using the Diagnostic Window in ProSoft Configuration Builder	93
5.2.3	Navigation	96
5.2.4	Main Menu	97
5.2.5	Database View Menu	99
5.2.6	IEC-870-5-104 Client Menu	101
5.2.7	Network Menu	104
6	Reference	105
6.1	Product Specifications	106
6.1.1	General Specifications	106
6.1.2	Internal Database	106
6.1.3	Hardware Specifications	108
6.1.4	Port Physical and Protocol Specifications	109
6.2	SNTP Support	110
6.2.1	SNTP Status Data	110
6.3	Server Error and Status Data	111
6.4	IEC 60870-5-104 Client Interoperability Statement	117
6.4.1	System or device	117
6.4.2	Application Layer	118
6.4.3	Selection of standard ASDUs	119
6.4.4	Type identifier and cause of transmission assignments	122
6.4.5	Basic Application Functions	122
7	Support, Service & Warranty	129
	Contacting Technical Support	129
7.1	Return Material Authorization (RMA) Policies and Conditions	131
7.1.1	Returning Any Product	131
7.1.2	Returning Units Under Warranty	132
7.1.3	Returning Units Out of Warranty	132
7.2	LIMITED WARRANTY	133
7.2.1	What Is Covered By This Warranty	133
7.2.2	What Is Not Covered By This Warranty	134
7.2.3	Disclaimer Regarding High Risk Activities	134

7.2.4	Intellectual Property Indemnity	135
7.2.5	Disclaimer of all Other Warranties	135
7.2.6	Limitation of Remedies **	136
7.2.7	Time Limit for Bringing Suit	136
7.2.8	No Other Warranties	136
7.2.9	Allocation of Risks	136
7.2.10	Controlling Law and Severability	136

Index	137
--------------	------------

Guide to the 104C Module Protocol Manual

Function		Section to Read	Details
Introduction (Must Do)	→	Start Here (page 10)	This section introduces the customer to the gateway. Included are: package contents, system requirements, hardware installation, and basic configuration.
Diagnostic and Troubleshooting	→	Diagnostics and Troubleshooting (page 91)	This section describes Diagnostic and Troubleshooting procedures.
Reference Product Specifications	→	Reference (page 105) Product Specifications (page 106)	These sections contain general references associated with this product and its Specifications..
Support, Service, and Warranty Index	→	Support, Service and Warranty (page 129) Index	This section contains Support, Service and Warranty information. Index of chapters.

1 Start Here

In This Chapter

- ❖ ProLinx Reference Guide 12
- ❖ Installing ProSoft Configuration Builder Software 13

For most applications, the installation and configuration steps described in this section will work without additional programming. ProSoft Technology strongly recommends that you complete the steps in this chapter before developing a custom application.

1.1 ProLinx Reference Guide

The *ProLinx Reference Guide* on the ProSoft Solutions CD-ROM provides detailed information on the entire range of ProLinx gateways. If you have any questions that are not answered in the 104C v3 Protocol Manual, please refer to the *ProLinx Reference Guide*.

1.2 Installing ProSoft Configuration Builder Software

You must install the *ProSoft Configuration Builder (PCB)* software to configure the gateway. You can always get the newest version of *ProSoft Configuration Builder* from the ProSoft Technology website.

To install ProSoft Configuration Builder from the ProSoft Technology website

- 1 Open your web browser and navigate to <http://www.prosoft-technology.com/pcb>
- 2 Click the link at the *Current Release Version* section to download the latest version of *ProSoft Configuration Builder*.
- 3 Choose **SAVE** or **SAVE FILE** when prompted.
- 4 Save the file to your *Windows Desktop*, so that you can find it easily when you have finished downloading.
- 5 When the download is complete, locate and open the file, and then follow the instructions on your screen to install the program.

If you do not have access to the Internet, you can install *ProSoft Configuration Builder* from the *ProSoft Solutions Product CD-ROM*, included in the package with your gateway.

To install ProSoft Configuration Builder from the Product CD-ROM

- 1 Insert the *ProSoft Solutions Product CD-ROM* into the CD-ROM drive of your PC. Wait for the startup screen to appear.
- 2 On the startup screen, click **PRODUCT DOCUMENTATION**. This action opens a *Windows Explorer* file tree window.
- 3 Click to open the **UTILITIES** folder. This folder contains all of the applications and files you will need to set up and configure your gateway.
- 4 Double-click the **SETUP CONFIGURATION TOOL** folder, double-click the **PCB_*.EXE** file and follow the instructions on your screen to install the software on your PC. The information represented by the "*" character in the file name is the *PCB* version number and, therefore, subject to change as new versions of *PCB* are released.

Note: Many of the configuration and maintenance procedures use files and other utilities on the CD-ROM. You may wish to copy the files from the *Utilities* folder on the CD-ROM to a convenient location on your hard drive.

1.2.1 Using the Online Help

Most of the information needed to help you use *ProSoft Configuration Builder* is provided in a Help System that is always available whenever you are running *ProSoft Configuration Builder*. The Help System does not require an Internet connection.

To view the help pages, start *ProSoft Configuration Builder*, open the **HELP** menu, and then choose **CONTENTS**.

2 Configuring the Gateway

In This Chapter

❖ IEC 60870-5-104 Client Section	16
❖ Using the CommonNet Data Map.....	35
❖ Downloading a File from PC to the Module	39
❖ Creating Optional Comment Entries.....	40
❖ Printing a Configuration File	41

2.1 IEC 60870-5-104 Client Section

The IEC-104 Client section allows the user to setup the following features:

- General Client driver parameters
- Client parameters to access each remote server (up to four)
- Monitored data configuration to receive data from remote servers
- Command (control) data configuration to send data to remote servers
- SNTP client parameters for clock update

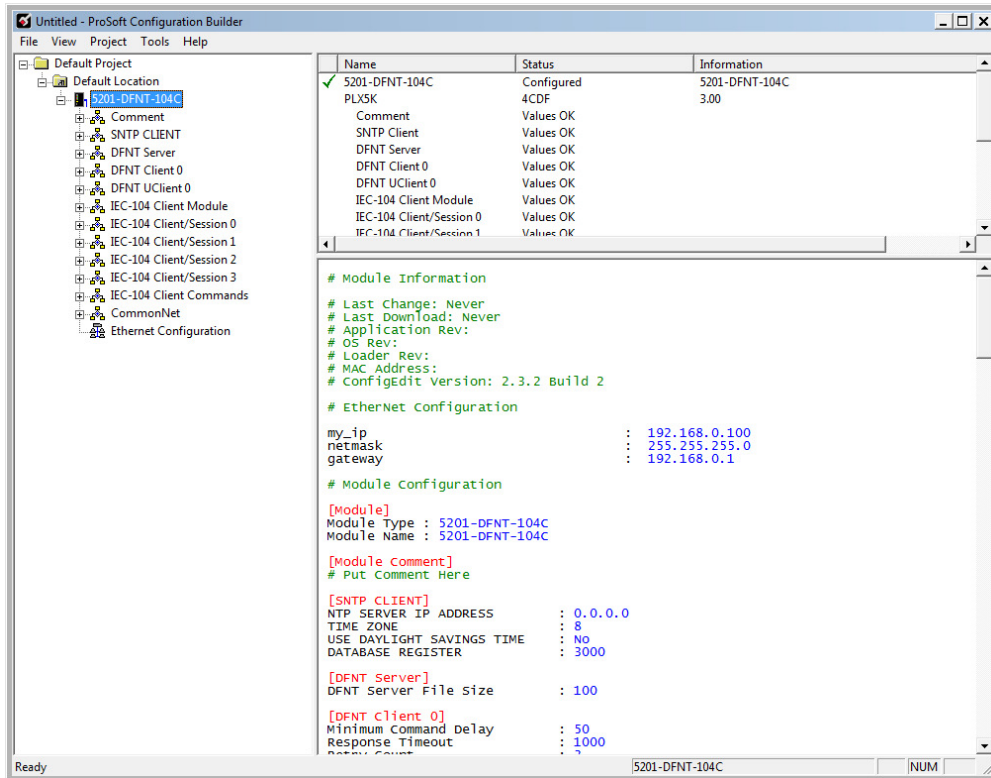

2.1.1 [SNTP CLIENT]

The [SNTP CLIENT] section of the configuration (.CFG) file or of the PCB configuration is used to specify the parameters for the Simple Network Time Protocol (SNTP) Client provided with the protocol driver. The Client is required in order to keep the driver's internal clock set correctly. This version of the driver supports SNTP Revision 3 and stratum between 1 and 14.

The updated time and date information is used when sending clock synchronization commands to remote IEC-60870-5-104 servers.

SNTP is used for time synchronization of produced and consumed commands. When an exchange occurs, the driver compares time stamps from the previous exchange. When the new exchange time is less than the previous exchange, the exchange is ignored. This can occur when the Ethernet packets are routed and delayed. Time synchronization provides for data integrity.

As Seen in the Configuration (.CFG) File

```
# This section used to define the parameters required for the Simple Network
Time
# Protocol (SNTP) client.
[SNTP CLIENT]
#SNTP SERVER IP ADDRESS      : 132.163.4.102  #IP address for NIST, Boulder,
Colorado
SNTP SERVER IP ADDRESS      : 0.0.0.0          #IP Address for SNTP Server
TIME ZONE                    : 8                #Number of hours from GMT (-11 to
+11)
USE DAYLIGHT SAVINGS TIME   : No              #Yes or No
DATABASE REGISTER            : 3000            #database word location to store
time

#(-1=ignore). This register value should
#be an even number.
```

As Seen in PCB

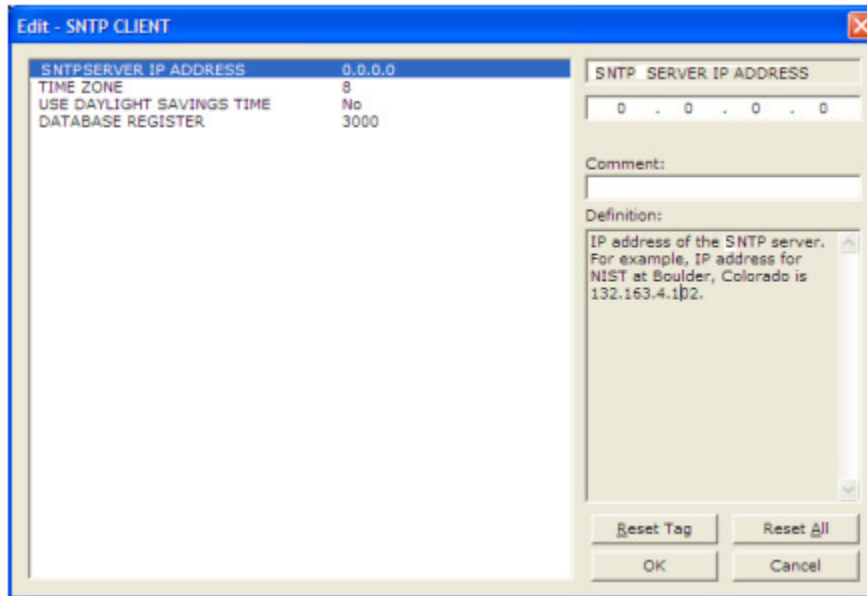

The SNTP driver will compute a new clock value every 5 minutes using the average value of 10 samples each collected over an approximate 6-second period. This new value will be used to adjust the clock maintained by the SNTP driver and used by the application. If a valid database register is specified, the driver will place the time value into the module's database. The first two registers will contain the number of seconds and the next two registers will contain the number of microseconds since January 1, 1970.

A list of some of the common SNTP servers can be obtained at <http://www.ntp.org/>

or, <http://support.ntp.org/bin/view/Servers/WebHome>

Other server lists can be found by searching the World Wide Web for *SNTP Servers*.

SNTP Server IP Address

Enter in dotted notation

This parameter sets the IP address of the SNTP server to utilize for time acquisition. Select an SNTP server with the greatest accuracy that can be accessed all the time from your network. Setting this IP address to 0.0.0.0 disables SNTP server requests.

Time Zone

-11 to 11

This parameter specifies the time zone offset to be used from the UTC time zone. A value of zero uses UTC time. If the value entered is positive, the time zone is west of the UTC time zone (for example, Eastern Standard Time is 5). If the value entered is negative, the time zone is east of the UTC time zone (for example, Continental Europe is -1).

Use Daylight Savings Time

YES or NO

This parameter specifies if daylight savings time will be used in the time computation.

Database Register

-1 or 0 to 3996 as an even value

This parameter specifies if the NTP time computed by the driver is to be placed into the module's database. If a value of -1 is specified, the time will not be placed into the database. If the value is between 0 and 3992, the time will be placed in the database. The first 4 bytes will represent the seconds since 1/1/1970, and the second 4 bytes will represent the number of microseconds. An even value should be used for the register value in order for the data to be stored correctly.

2.1.2 [IEC-870-5-104]

This section provides the parameters required for general driver configuration. Most entries contained within this section are self-explanatory.

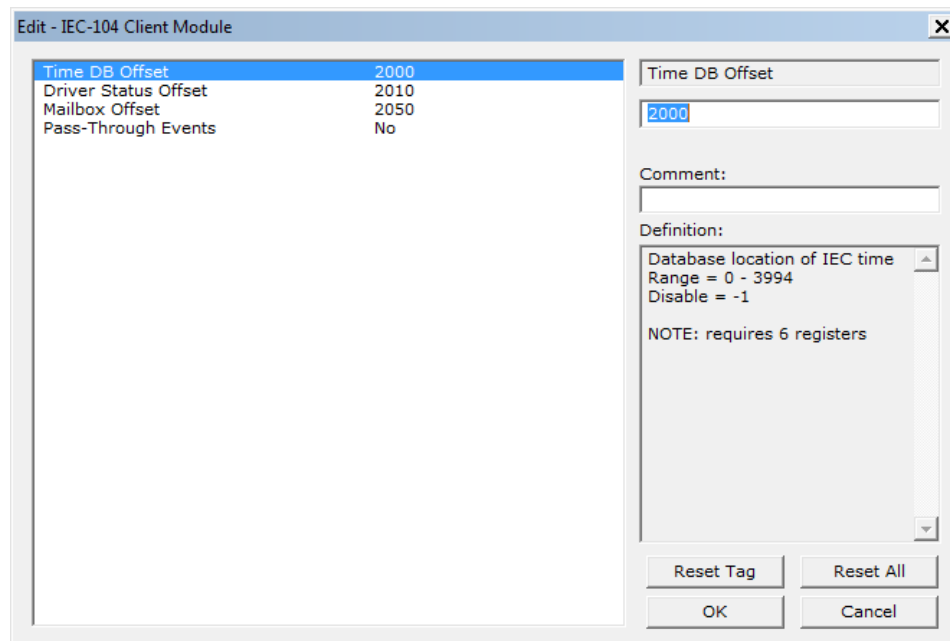

Time DB Offset

-1 or 0 to 3994

This parameter sets the location in the database where the gateway's 104C Client date and time will be copied to.

Note: The following table lists the 12-byte data area placed in the database if the *Time DB Offset* parameter is set to a value other than -1:

Byte	Length	Range	Description
0 to 1	2	0 to 59,999	Seconds and milliseconds
2	1	0 to 59	Minutes
3	1	0 to 23	Hour
4	1		Reserved
5	1	1 to 31	Day of the month
6	1	1 to 12	Month
7 to 8	2	0 to 65,535	Year (four-digit format, for example 2005)
9	1		Reserved
10	1	0 or 1	Invalid flag (0 = Valid, 1 = Invalid)
11	1		Reserved

Driver Status Offset

0-3982

Database location of general client driver status data

Disable = -1

Refer to section 6.3 (Server Error and Status Data) for the detailed contents of the status block.

NOTE: requires 18 registers

Mailbox Offset

0 - 3872

Database offset to the mailbox interface area. This feature is applicable to the 5201-DFNT-104C module. The mailbox allows the DFNT driver to request specific tasks from the 104 driver such as time update and dynamically sending commands

Disable = -1

Refer to section 4 (Mailbox feature) for further information about the mailbox functionality.

The mailbox interface requires 128 database registers.

Pass-Through Events

This parameter specifies if spontaneous event messages received from the servers will be passed to the mailbox interface. If the parameter is set to N, event messages will not be passed to the mailbox interface. If the parameter is set to Y, the driver will pass all events received to the mailbox interface using mailbox identifier 9903 & -9903. The Mailbox Interface should be enabled by setting a valid value for "Mailbox Offset" if this feature is utilized.

2.1.3 [IEC-60870-5-104 Client x]

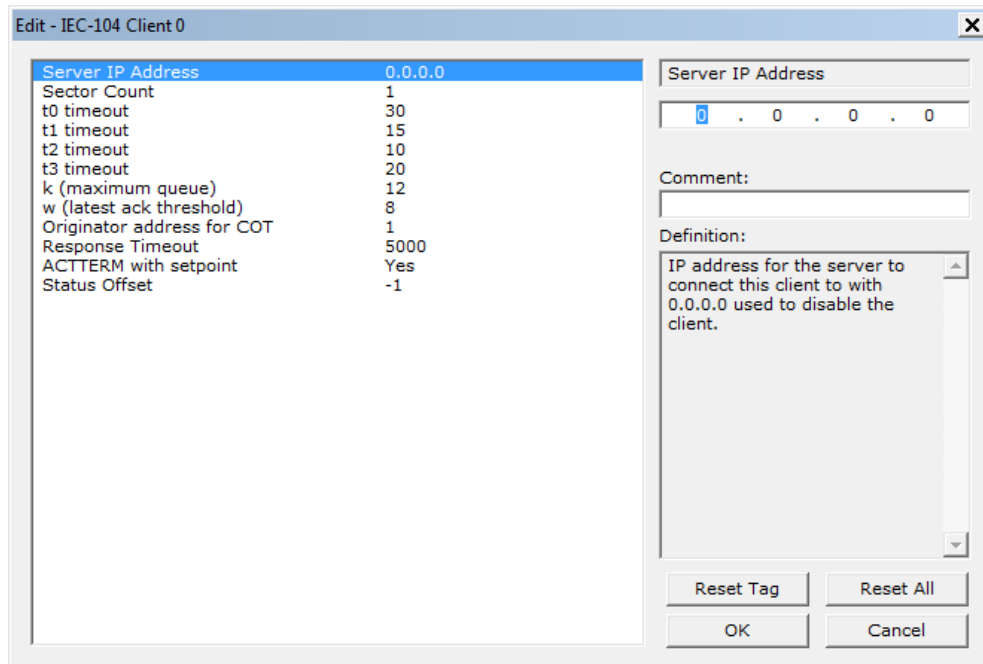

Server IP Address

IP address of the remote server that will be connected to this client

Sector Count - 1 to 2

1 to 2

This parameter sets the number of Sectors (separate databases or *Multiple Application Layer ASDU* addresses) contained in this Session (controlled device). This version of the application supports 1 to 2 sectors for each Client/session.

t0 Connection Timeout

1 to 30, default value = **30**

This is a timeout value, in seconds, to determine if a connection has been lost with the remote server. If no traffic from the remote server is received for the period of time specified by this parameter, the currently open IP socket connection will be closed. The connection can be re-established by the Client by opening a new connection.

t1 Timeout Set Value

1 to 255 DEFAULT VALUE = 15

This is the timeout of send or test ASDUs and is in units of seconds. After a packet is sent from the unit, the server must acknowledge the packet within this time interval or else the unit will close the connection.

t2 Timeout Set Value

1 to 255 DEFAULT VALUE = 10

This is a timeout of when to send an S-format message to the host to acknowledge outstanding messages received. This parameter is in units of seconds and must be less than the value set for *t1*.

t3 Timeout Set Value

1 to 255 DEFAULT VALUE = 20

This is the timeout to wait on an idle line before the unit will send a TestFr.Act message. This value is in units of seconds.

k (maximum queue)

1 to 20 DEFAULT VALUE = 6

This parameter specifies the number of unacknowledged messages the unit will buffer. This parameter must match that in the server. If the set number of buffers is filled in the unit, no other messages will be sent until the server unit acknowledges some or all the messages.

w (latest ack threshold)

1 to 20 DEFAULT VALUE = 4

This parameter must match that of the server unit and specifies the number of messages the gateway will receive before sending an S-format sequence acknowledge message when no I-format data is ready to send. It is recommended to set this value to 2/3 the value of *k*.

Originator address for COT

0 to 255 DEFAULT VALUE = 1

This parameter sets the address to be passed with each message when the COT Octet Count parameter is set to 2.

Response Timeout

0 to **5000** milliseconds DEFAULT VALUE = 5000

This parameter sets the maximum number of milliseconds to wait for a confirmation from the controlled station to a request from this module to application level messages.

ACTTERM with Set Point

Y - **YES** or **N** - **NO**

This parameter determines if an ACTTERM (Activation Termination) will be sent. If the parameter is set to **YES**, then Set point commands will issue an ACTTERM when the command is complete. If the parameter is set to **NO**, ACTCON (Activation Confirmation) is the last response to a Set point command.

Status Offset

Range -1 to 3956

Database location of client status data

Range = 0 - 3956

Disable = -1

(Refer to the status section for further information about the content of this section).

NOTE: requires 44 registers

2.1.4 [IEC-60870-5-104 Client x Sector x] Parameters

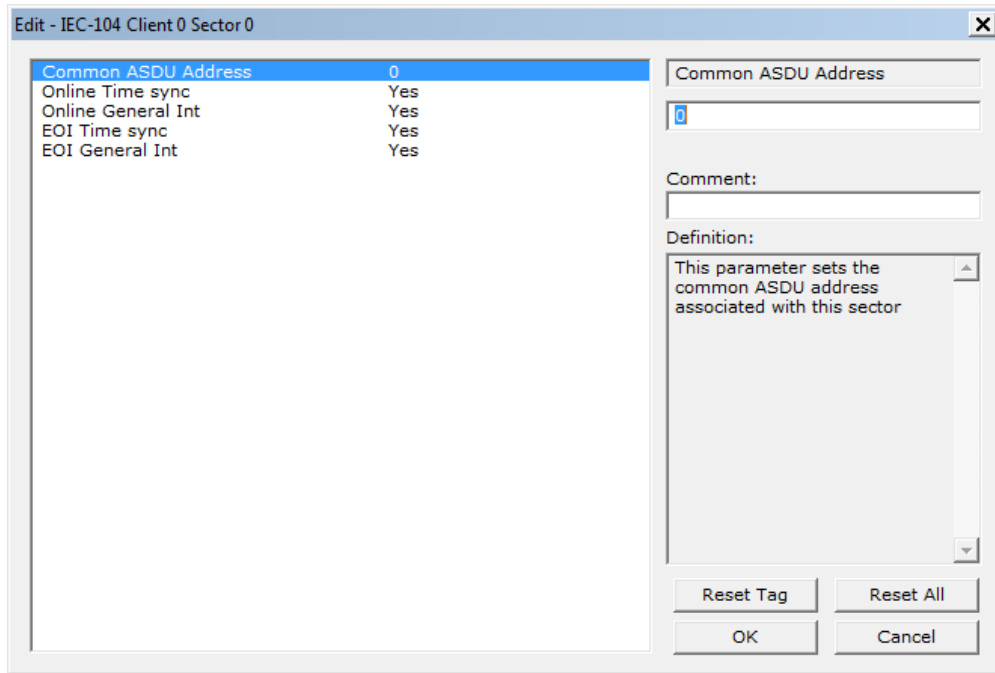

Common ASDU Address

At the application level, the gateway is identified by the *Common ASDU (Application Service Data Unit) Address*. This address must match the CASDU sent at the server unit. An ASDU is a data unit that transfers information objects between the Client and the server.

If the gateway sends a message to a different Common ASDU, the server should ignore the command.

Online Time Sync

Yes or No

This parameter specifies if the sector in the server device will be sent a time synchronization command when the server device is first recognized as being online. This should only be used for devices that do not send an *EOI* message after initializing.

Online General Int

Yes or No

This parameter specifies if the sector in the server will be sent a general interrogation command when the unit is first recognized as being online.

EOI Time Sync

Yes or No

This parameter specifies if the sector in the server device will be sent a time synchronization command after this module received an *EOI (End of Initialization)* message from the server device.

EOI General Int

Yes or No

This parameter specifies if the sector in the server will be sent a general interrogation command after this module receives an EOI message from the controlled unit.

2.1.5 [IEC-60870-5-104 Client x Sector y]

This section allows the user to associate the monitored data points to module database. These points are sent from the remote server to the module. There are 3 parameters for each point association that you create: Data Type, Point Index, Database Address.

The data type must be selected among one of the following supported types. The Point Index is the Information Object Address which identifies the point in the network. The Database Address defines the gateway database location on where the point value will be stored. The database address could be defined as bit-addressing, byte addressing, word addressing or double-word addressing depending on the data type.

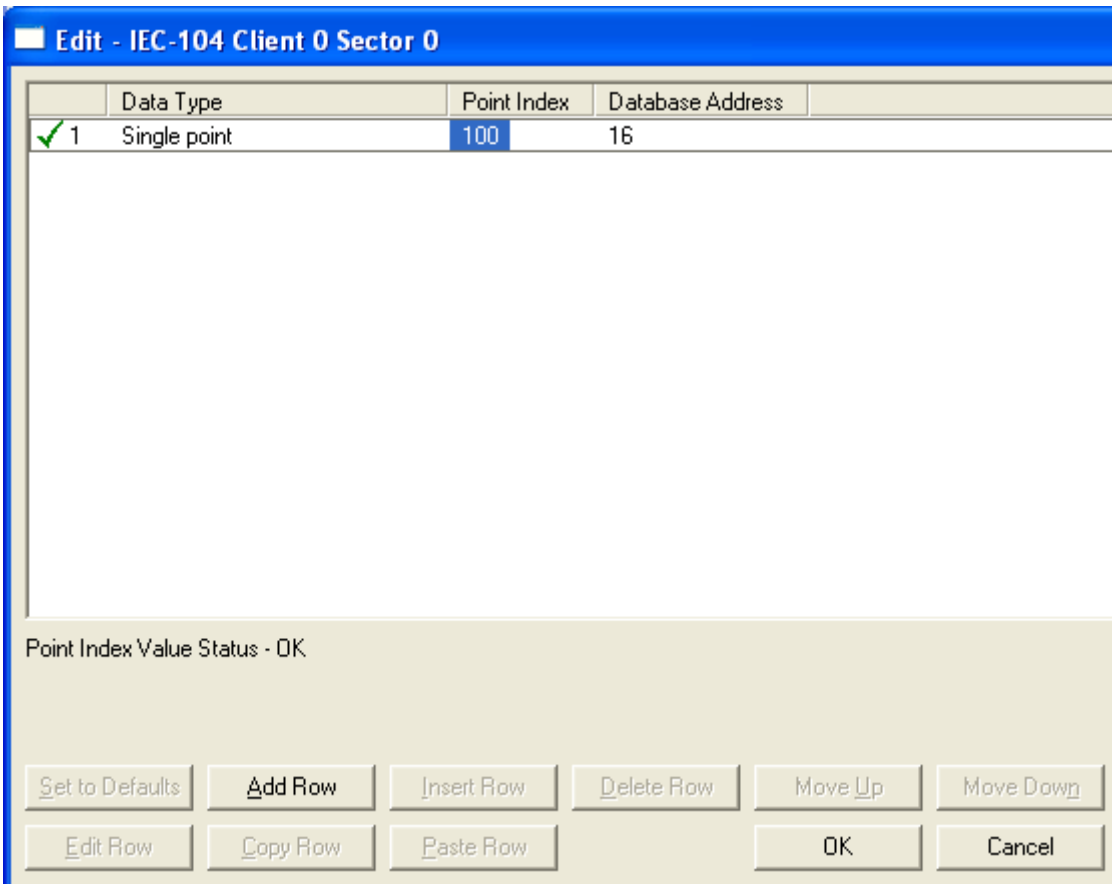

For additional information on how to set these parameters, see the Reference chapter of this manual. The following ASDU data types are supported:

Monitor Single Point [M SP NA]

This section defines the *Monitor Single-Point* information object database. Each information object (point) indicates one of two states, **1** = Bit On, **0** = Bit Off. Each information object is one bit and the *DB Address* value corresponds to the bit offset in the gateway memory database. For additional information on how to set these parameters, see the *Reference* chapter of this manual.

Monitor Double Point [M DP NA]

Each information object in the database can have one of four possible states, **00** = Intermediate, **01** = Off, **10** = On, and **11** = Intermediate. Each information object is two bits and the *DB Address* value corresponds to the bit offset in the gateway memory database.

Monitor Step Position [M ST NA]

Each information object is one 8-bit byte and the *DB Address* value corresponds to the byte offset in the gateway memory database.

[M BO NA 1 104]

Each information object is four 8-bit bytes (two 16-bit words) and the *DB Address* value corresponds to the double-word offset in the gateway memory database.

Monitor Normalized Measured [M ME NA]

Each information object is one 16-bit word and the *DB Address* value corresponds to the word offset in the gateway memory database.

Monitor Scaled Measured [M ME NB]

Each information object is one 16-bit word and the *DB Address* value corresponds to the word offset in the gateway memory database.

Monitor Short Floating-Point [M ME NC]

Each information object is two 16-bit words and the *DB Address* value corresponds to the double-word offset in the gateway memory database.

Monitor Integrated Totals (Counter) [M IT NA]

Each information object is two 16-bit words and the *DB Address* value corresponds to the double-word offset in the gateway memory database.

2.1.6 [IEC-60870-5-104 Client Commands]

Each row of this section allows the configuration of one command to be sent to the remote server. The command can be either a control point (single point, double-point, etc..) or a general command such as clock synchronization to a specific client.

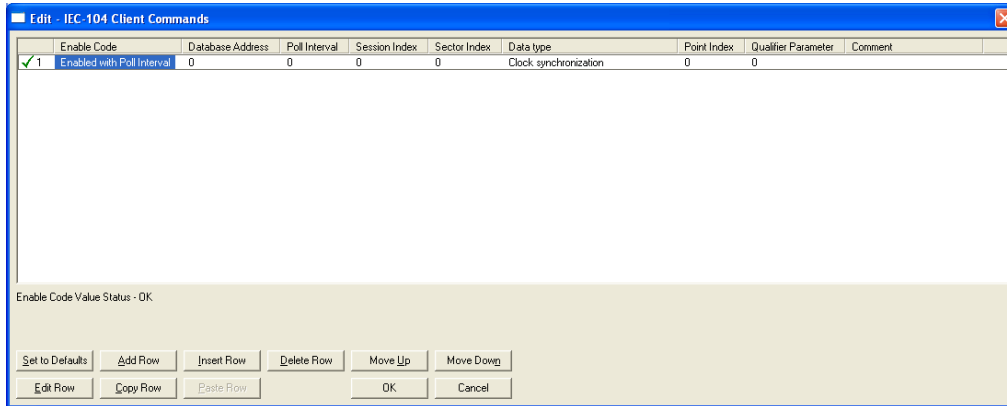

The following parameters must be configured for each command:

Enable Code

This field determines when the command will be executed according to the following codes:

Value	Description
Disabled	Command is disabled and will only execute if enabled from mailbox interface (see mailbox interface for further details)
Enabled with Poll Interval	Command will execute no more frequently than the time set in the Poll interval parameter
Conditional	Command will execute when the last value read in the database differs from the current value

Database Address

The interpretation for the database address parameter will depend on the selected data type. The database address value is only significant to the control data types (single point, double-point, etc...).

Examples:

If you select single point command type the database address is interpreted as a bit-address. For example, a value of 32 means bit 0 of database word 2.

If you select regulating step point command type the database address is interpreted as a byte-address. For example, a value of 32 means byte 0 of database word 16.

If you select measured scaled integer command type the database address is interpreted as a word-address. For example, a value of 32 means database word 32

If you select measured scaled integer command type the database address is interpreted as a double-word-address. For example, a value of 32 means database word 16, For the other command types (clock synchronization, read command, reset process command and test command) you can use the database address to trigger the command upon data change. However the value itself is not used within the command.

FIELD	DESCRIPTION																																																						
Database Index	This field specifies the location in the module's internal database to associate with the command. The data type used in the command determines addressing of the index as follows:																																																						
	<table border="0"> <thead> <tr> <th>Type</th> <th>Description</th> <th>DB Index type</th> </tr> </thead> <tbody> <tr> <td>45</td> <td>Single point Command</td> <td>Bit address</td> </tr> <tr> <td>46</td> <td>Double point Command</td> <td>Bit address</td> </tr> <tr> <td>47</td> <td>Regulating Step point Command</td> <td>Byte address</td> </tr> <tr> <td>48</td> <td>Setpoint, normalized point Command</td> <td>Word address</td> </tr> <tr> <td>49</td> <td>Setpoint, scaled point Command</td> <td>Word address</td> </tr> <tr> <td>50</td> <td>Setpoint, short float point Command</td> <td>Double-word address</td> </tr> <tr> <td>51</td> <td>Bitstring (32-bits) point Command</td> <td>Double-word address</td> </tr> <tr> <td>100</td> <td>Group interrogation command</td> <td>*Word address</td> </tr> <tr> <td>101</td> <td>Counter interrogation command</td> <td>*Word address</td> </tr> <tr> <td>102</td> <td>Read command</td> <td>*Word address</td> </tr> <tr> <td>103</td> <td>Clock synchronization command</td> <td>*Word address</td> </tr> <tr> <td>105</td> <td>Reset process command</td> <td>*Word address</td> </tr> <tr> <td>107</td> <td>Test command (IEC-870-5-104 type)</td> <td>*Word address</td> </tr> <tr> <td>110</td> <td>Parameter, normalized measured value</td> <td>Word address</td> </tr> <tr> <td>111</td> <td>Parameter, scaled measured value</td> <td>Word address</td> </tr> <tr> <td>112</td> <td>Parameter, short float value</td> <td>Float (double-word address)</td> </tr> <tr> <td>113</td> <td>Parameter activation command</td> <td>*Word address</td> </tr> </tbody> </table>	Type	Description	DB Index type	45	Single point Command	Bit address	46	Double point Command	Bit address	47	Regulating Step point Command	Byte address	48	Setpoint, normalized point Command	Word address	49	Setpoint, scaled point Command	Word address	50	Setpoint, short float point Command	Double-word address	51	Bitstring (32-bits) point Command	Double-word address	100	Group interrogation command	*Word address	101	Counter interrogation command	*Word address	102	Read command	*Word address	103	Clock synchronization command	*Word address	105	Reset process command	*Word address	107	Test command (IEC-870-5-104 type)	*Word address	110	Parameter, normalized measured value	Word address	111	Parameter, scaled measured value	Word address	112	Parameter, short float value	Float (double-word address)	113	Parameter activation command	*Word address
Type	Description	DB Index type																																																					
45	Single point Command	Bit address																																																					
46	Double point Command	Bit address																																																					
47	Regulating Step point Command	Byte address																																																					
48	Setpoint, normalized point Command	Word address																																																					
49	Setpoint, scaled point Command	Word address																																																					
50	Setpoint, short float point Command	Double-word address																																																					
51	Bitstring (32-bits) point Command	Double-word address																																																					
100	Group interrogation command	*Word address																																																					
101	Counter interrogation command	*Word address																																																					
102	Read command	*Word address																																																					
103	Clock synchronization command	*Word address																																																					
105	Reset process command	*Word address																																																					
107	Test command (IEC-870-5-104 type)	*Word address																																																					
110	Parameter, normalized measured value	Word address																																																					
111	Parameter, scaled measured value	Word address																																																					
112	Parameter, short float value	Float (double-word address)																																																					
113	Parameter activation command	*Word address																																																					
	*Word address = Value only used to signal when to send event (Enable Code = 2)																																																						

Poll Interval

This parameter is used if the Enable Code field is set as Enabled With Poll Interval. It sets the minimum number of seconds to delay between successive execution of the command.

Session

This parameter is utilized to associate the command with one of the sessions/clients defined for the module.

Sector

This parameter is used to associate the command with the proper sector of the selected session.

Data Type

This parameter is used to set the ASDU data type to be used with the message. The codes specified are those defined for the IEC-870-5-101 protocol. The following is a listing of command control data types supported in this module:

Type	Description
----	-----
45	Single point command
46	Double point command
47	Regulating step point command
48	Setpoint, normalized point command
49	Setpoint, scaled point command
50	Setpoint, short float point command
51	Bitstring (32-bits) point command
100	General or group interrogation command
101	Counter interrogation command
102	Read command
103	Clock synchronization command
105	Reset process command
107	Test command (IEC-870-5-104 type)
110	Parameter setting for normalized measured value
111	Parameter setting for scaled measured value
112	Parameter setting for short float value
113	Parameter activation command

Point Index

This parameter specifies the Information Object Address in the server device that corresponds to the command.

Qualifier Parameter

This parameter specifies qualifiers required by the command. This parameter is dependent on the ASDU data type associated with the command as follows:

SINGLE POINT (45), DOUBLE POINT (46) AND REGULATING STEP (47):
Value:
Single Point Value:
0=Off
1=On
Double Point Value:
0=Not permitted
1=Off
2=On
3=Not Permitted
Regulating Point Value:
0=Not permitted
1=Next step lower if database point is set to -1
2=Next step high if database point set to +1
3=Not Permitted
Qualifier used:
Qualifier Code:
0=No additional definition (slave dependent)
4=Short pulse duration
8=Long pulse duration
12=Persistent output
Select/Execute:
0=Direct execution without select
128=Select executed followed by execute
256=Deselect command
Use Override Flag:
0=Use value in database for value
512=Use override value for state
NORMALIZED (48), SCALED (49) AND SHORT FLOAT (50) SETPOINTS:
Value:
Value read from database for point specified

Qualifier used:
0=Direct execution without select
1=Select executed followed by execute
2=Deselect command
32-BITSTRING SETPOINT (51):
Value:
Value read from database for point specified
Qualifier used:
None used
INTERROGATION GROUP COMMAND (100):
Value:
None used for this command with Database Index parameter ignored.
Qualifier used:
0=Not used
1 to 19 = Reserved by standard
20=Station interrogation (global)
21=Interrogation group 1
22=Interrogation group 2
23=Interrogation group 3
24=Interrogation group 4
25=Interrogation group 5
26=Interrogation group 6
27=Interrogation group 7
28=Interrogation group 8
29=Interrogation group 9
30=Interrogation group 10
31=Interrogation group 11
32=Interrogation group 12
33=Interrogation group 13
34=Interrogation group 14
35=Interrogation group 15
36=Interrogation group 16
37 to 63 = Reserved by standard
64 to 255 = Reserved for special use (private range)
COUNTER INTERROGATION GROUP COMMAND (101):
Value:
None used for this command with Database Index parameter ignored.
Qualifier Used:
Counter Interrogation Group:
0=No counter requested
1=Request counter group 1

2=Request counter group 2
3=Request counter group 3
4=Request counter group 4
5=Request general counter group
6 to 31 = Reserved by standard
32 to 63 = Reserved for special use (private range)
Freeze/Reset Qualifier:
0=No freeze or reset
64=Counter freeze without reset
128=Counter freeze with reset
192=No freeze with counter reset
READ COMMAND (102):
Value:
No value in database utilized. Data for the Point Index in the slave is requested.
Qualifier used:
None used
CLOCK SYNCHRONIZATION COMMAND (103):
Value:
No value in database utilized.
Qualifier used:
0=Clock synchronization
TEST COMMAND (107=104 STANDARDS):
Value:
No value in database utilized.
Qualifier used:
None used
RESET COMMAND (105):
Value:
No value in database utilized.
Qualifier used:
0=Not used
1=General reset of process
2=Reset pending information with time tag of the event buffer
3 to 127 = Reserved by standard
128 to 255 = Reserved for special use (private range)

PARAMETER SETTING FOR NORMALIZED (110), SCALED (111), SHORT FLOAT (112):
Value:
Value from module's database utilized for the parameter
Qualifier used:
Kind of parameter:
0=Not used
1=Threshold value
2=Smoothing factor (filter time constant)
3=Low limit for transmission of measured values
3=High limit for transmission of measured values
5 to 31 = Reserved by standard
32 to 63 = Reserved for special use (private range)
Local parameter change:
0=No change
64=Change
Parameter in operation:
0=Operation
128=Not in operation
PARAMETER ACTIVATION COMMAND (113):
Value:
No database value used with this command
Qualifier used:
Parameter Qualifier:
0=Not used
1=Act/Deact of previously loaded parameters (point index = 0)
2=Act/Deact of the parameter of the point index specified
3=Act/Deact of persistent cyclic or periodic transmission of the addressed object
4 to 127 = Reserved by standard
128 to 255 = Reserved for special use (private range)
Activation Qualifier:
0=Deactivate
256=Activate

2.2 Using the CommonNet Data Map

The *Data Map* section allows you to copy data between areas in the gateway's internal database.

You can copy a maximum of 100 registers per *Data Map* command, and you can configure a maximum of 200 separate copy commands.

You can copy data from the error or status tables in upper memory to internal database registers in the *User Data memory* area.

You can rearrange the byte and/or word order during the copy process. For example, by rearranging byte or word order, you can convert floating-point values to the correct format for a different protocol.

You can also use the *Data Map* to condense widely dispersed data into one contiguous data block, making it easier to access.

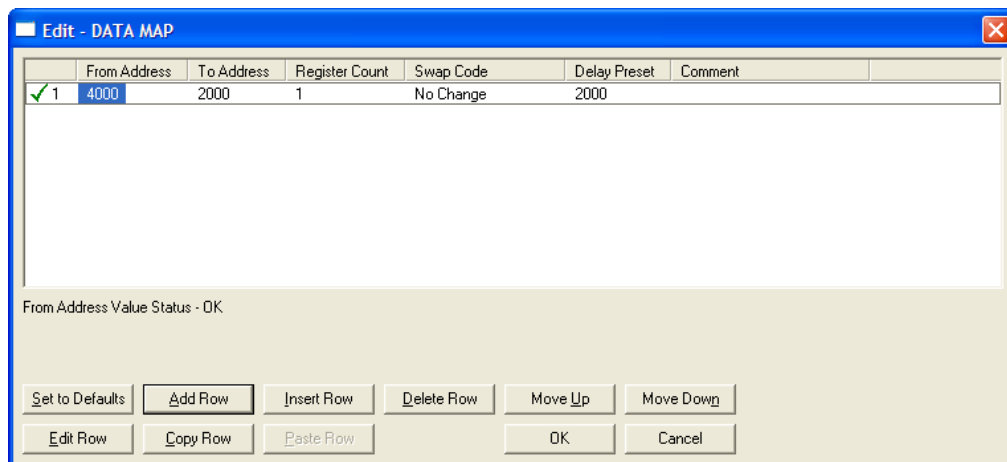
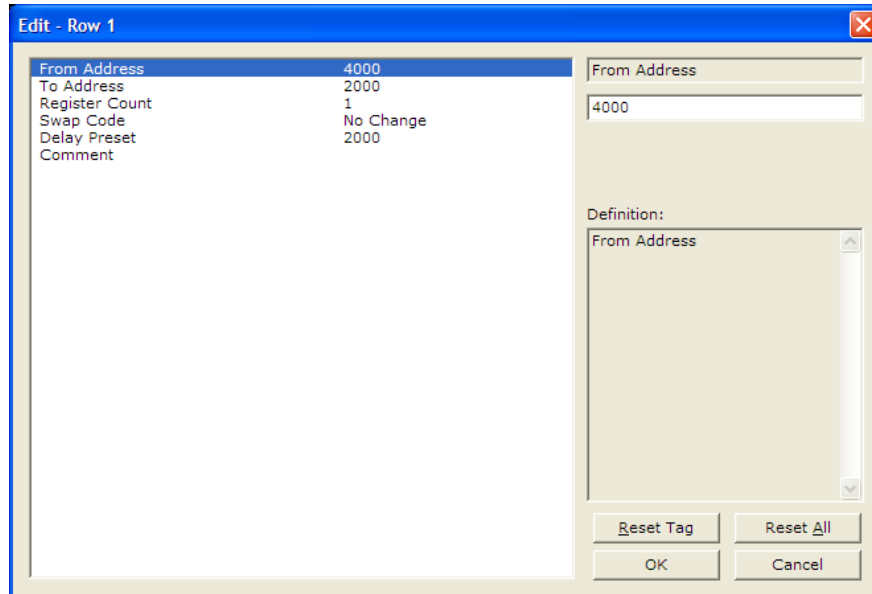

2.2.1 From Address

0 to highest *Status Data* address

This field specifies the beginning internal database register address for the copy operation. This address can be any valid address in the *User Data Area* or the *Status Data Area* of the gateway.

2.2.2 To Address

0 to **3999**

This parameter specifies the beginning destination register address for the copy operation. This address must always be within the *User Data registers* area. Take care to specify a destination address that will not overwrite data that has been stored in memory by one of the communication protocols running on the gateway.

2.2.3 Register Count

1 to **100**

This parameter specifies the number of registers to copy.

2.2.4 Swap Code

NO CHANGE, WORD SWAP, WORD AND BYTE SWAP, BYTE SWAP

You may need to swap the order of the bytes in the registers during the copy process in order to change the alignment of bytes between dissimilar protocols. This parameter is helpful when dealing with floating-point or other multi-register values, as there is no standard method of storage of these data types in slave devices.

The following table defines the values and their associated operations:

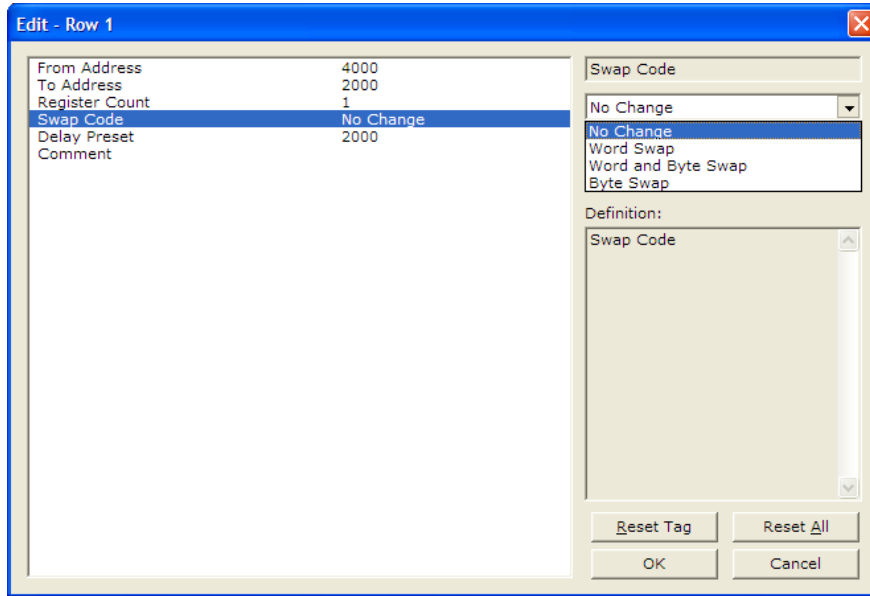

Swap Code	Description
No Swap	No change is made in the byte ordering (1234 = 1234)
Word Swap	The words are swapped (1234=3412)
Word and Byte Swap	The words are swapped, then the bytes in each word are swapped (1234=4321)
Bytes	The bytes in each word are swapped (1234=2143)

2.2.5 Delay Preset

This parameter sets an interval for each *Data Map* copy operation. The value you put for the *Delay Preset* is not a fixed amount of time. It is the number of firmware scans that must transpire between copy operations.

The firmware scan cycle can take a variable amount of time, depending on the level of activity of the protocol drivers running on the ProLinx gateway and the level of activity on the gateway's communication ports. Each firmware scan can take from 1 to several milliseconds to complete. Therefore, *Data Map* copy operations cannot be expected to happen at regular intervals.

If multiple copy operations (several rows in the *Data map* section) happen too frequently or all happen in the same update interval, they could delay the process scan of the gateway protocols, which could result in slow data updates or missed data on communication ports. To avoid these potential problems, you should set the *Delay Preset* to different values for each row in the *Data Map* section and set them to higher, rather than lower, numbers.

For example, *Delay Preset* values below 1000 could begin to cause a noticeable delay in data updates through the communication ports. And you should not set all *Delay Presets* to the same value. Instead, use different values for each row in the *Data Map* such as 1000, 1001, and 1002 or any other different *Delay Preset* values you like. This will prevent the copies from happening concurrently and prevent possible process scan delays.

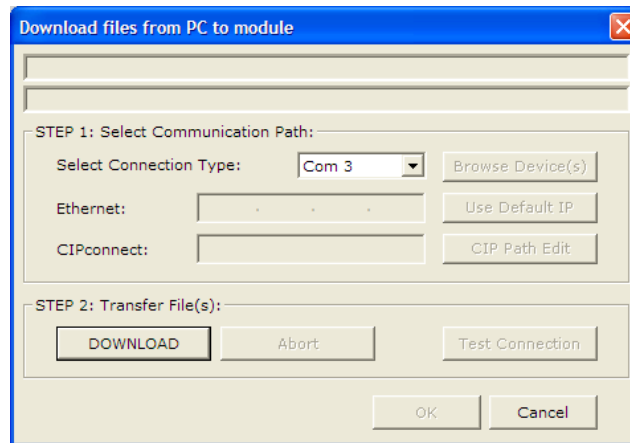

2.3 Downloading a File from PC to the Module

- 1 Use a null-modem serial cable to connected the serial COM port on your PC and the Debug/Configuration serial port on the gateway.
- 2 Open the **PROJECT** menu, and then choose **MODULE**.
- 3 On the **MODULE** menu, choose **DOWNLOAD**. Wait while ProSoft Configuration scans for communication ports on your PC. When the scan is complete, the *Download* dialog box opens.



- 4 Select the **PORT** to use for the download.
- 5 Click the **DOWNLOAD** button.

2.4 Creating Optional Comment Entries

- 1 Click the **[+]** to the left of the  **Comment** icon to expand the module comments.
- 2 Double-click the  **Module Comment** icon. The *Edit - Module Comment* dialog box appears.

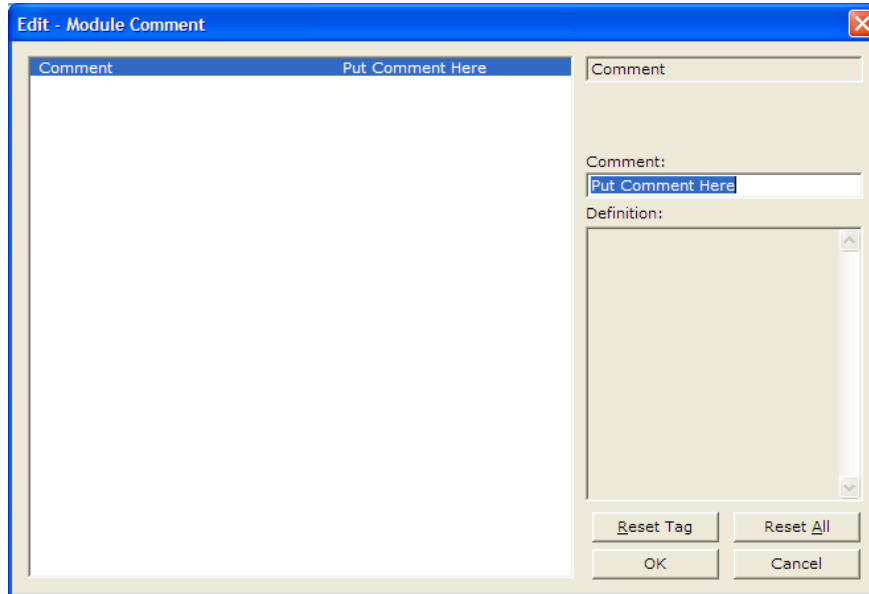

- 3 Enter your comment and click **OK** to save your changes.

2.5 Printing a Configuration File

- 1 Select the module icon, and then click the right mouse button to open a shortcut menu.
- 2 On the shortcut menu, choose **VIEW CONFIGURATION**. This action opens the *View Configuration* window.
- 3 In the *View Configuration* window, open the **FILE** menu, and choose **PRINT**. This action opens the *Print* dialog box.
- 4 In the *Print* dialog box, choose the printer to use from the drop-down list, select printing options, and then click **OK**.

3 IEC-60870-5-104 Protocol Implementation

In This Chapter

- ❖ Module Address 44
- ❖ Monitor Direction and Control Direction: Information Object Definition.. 46
- ❖ Using Monitor Points 49
- ❖ Using Control (Command) Information Objects..... 57

The intent of this section is to provide a quick understanding of how the 104 gateway implements the IEC-60870-5-104 protocol, without going into complex details of the specification.

The IEC-60870-5-104 protocol applies to telecontrol equipment and data transmission systems for monitoring and controlling geographically widespread processes. This protocol is similar to the IEC-60870-5-101 protocol, with the addition of TCP/IP as the transport mechanism.

Any application with the IEC-60870-5-104 protocol consists of a Client (Controlling Station) and one or more servers (Controlled Stations). The Client constantly monitors and controls the data from each server in the TCP/IP network.

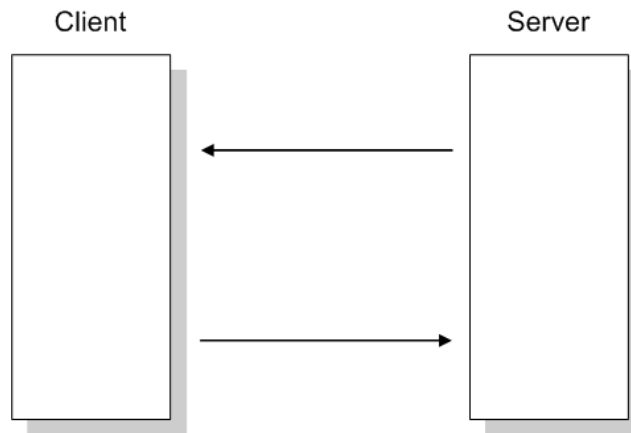

3.1 Module Address

The 104C Module gateway is identified at transport level using the IP Address.

3.1.1 IP Address

The 104C Module gateway is identified by a unique IP address on the TCP/IP network. You must edit the WATTCP.CFG configuration file (or use the configuration tool) to enter a valid IP address. The following example lists the default contents of the WATTCP.CFG file:

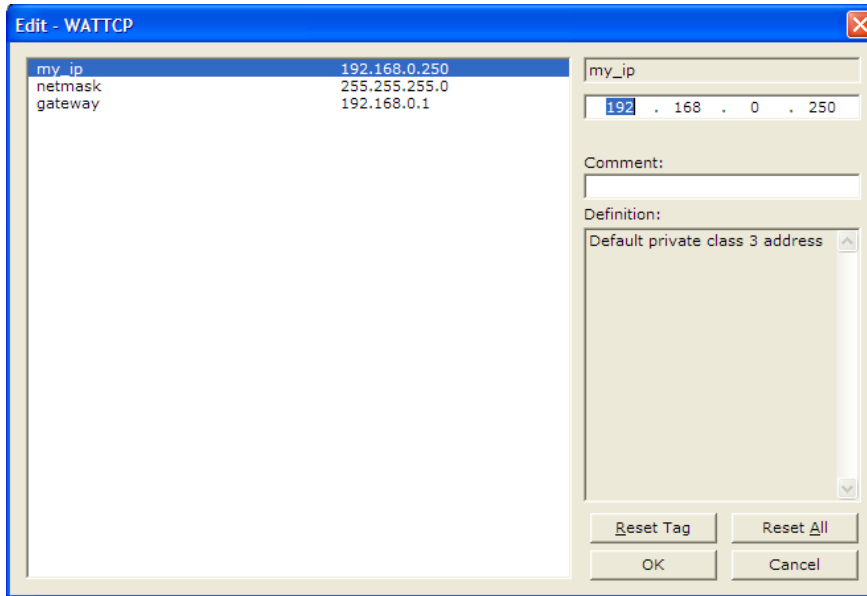

In this example, the 104C Module gateway is identified by *IP address* 192.168.0.250 in the IEC-60870-5-104 network, with a *netmask* (subnet mask) of 255.255.255.0 and a default *gateway* address of 192.168.0.1.

Remote Server Identification

The remote server is identified first by its IP address which you can enter through the Client X section:

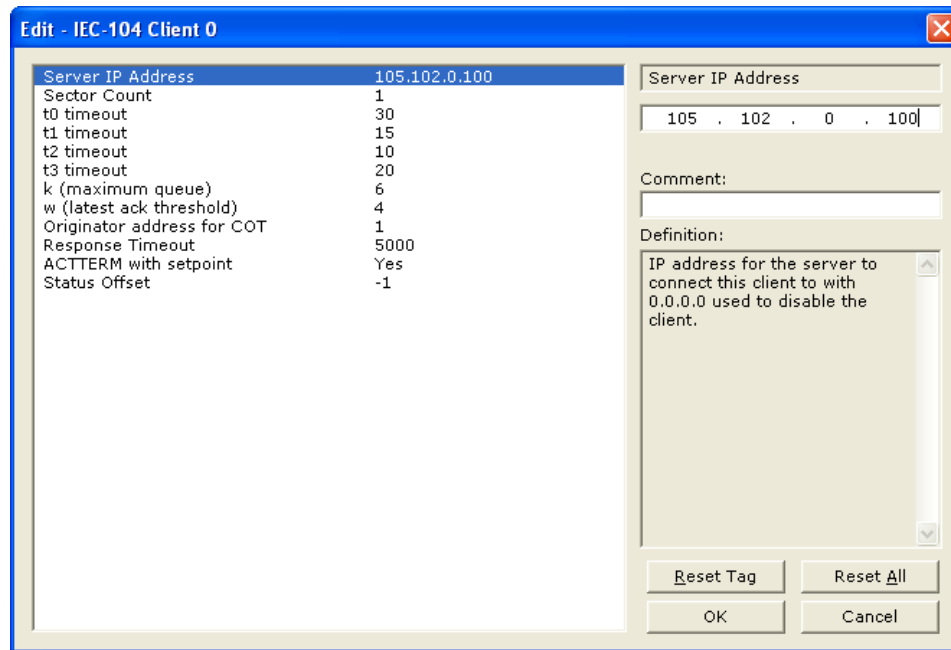

You may configure up to four remote servers to be communicating simultaneously with the module.

You must also identify the Common ASDU Address in the server. This value is identified through the Client X Sector Y section. Each server can be associated with up to two sectors with distinct Common ASDU Addresses. The Commons ASDU address must be greater than 0.

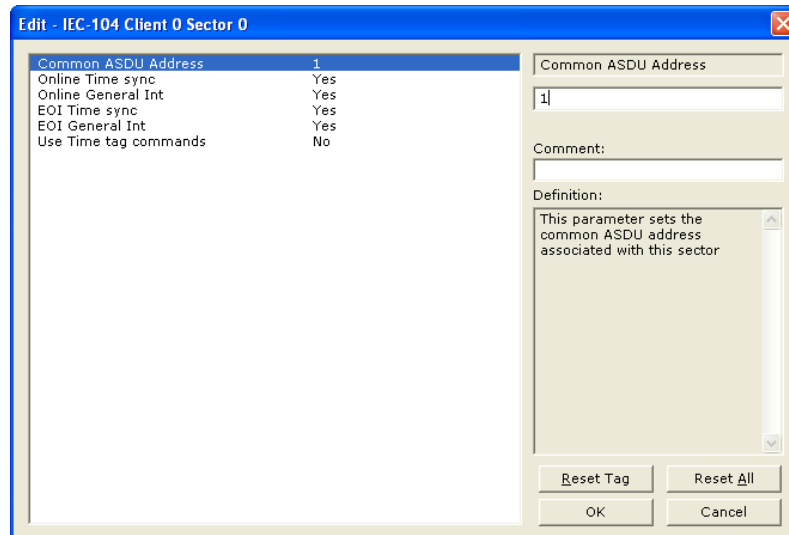

3.2 Monitor Direction and Control Direction: Information Object Definition

The protocol specification defines two directions of data transmission: Monitor direction and Control direction.

Monitor Direction: The direction of transmission from a server to the Client (gateway)

Control Direction: The direction of transmission from the Client (gateway) to a server

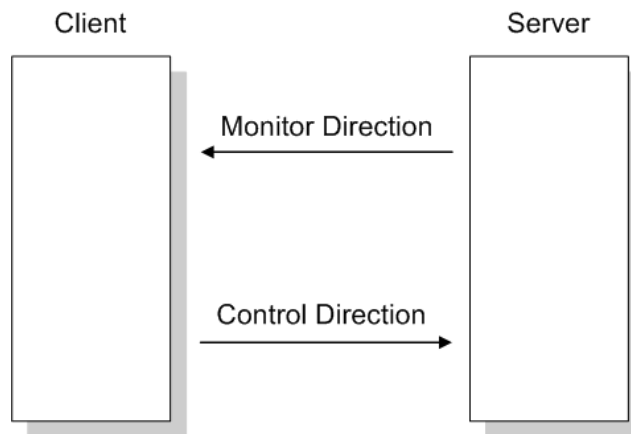

The data that is transferred from a server to a Client is known as Monitor information objects (or Monitor points). The data that is transferred from a Client to a server is known as Control information objects (or Control points).

The 104C Module contains an internal database of 4000 16-bit words. You must associate the Monitor and Control information objects to database addresses in the 104C Module. To configure the information objects for the 104C Module, follow these steps:

- 1 Calculate the number of Monitor and Control information objects for the application. The total number of monitor points must be equal or less than 1000. The total number of control points (commands) must be equal or less than 500 points.
- 2 Calculate the 104C Module database regions that are required for the application, based on the number of Monitor and Control information objects. Define two separate regions. Remember that each data type stores a different quantity of data (for example, *M_SP_NA* uses one bit, *M_ST_NA* uses one byte, and so on).
- 3 Configure each information object within its 104C Module database region.

- 4 Make sure that the other parts of your application correctly update the gateway database regions associated with the configured 104C data types, as shown in the following illustration.

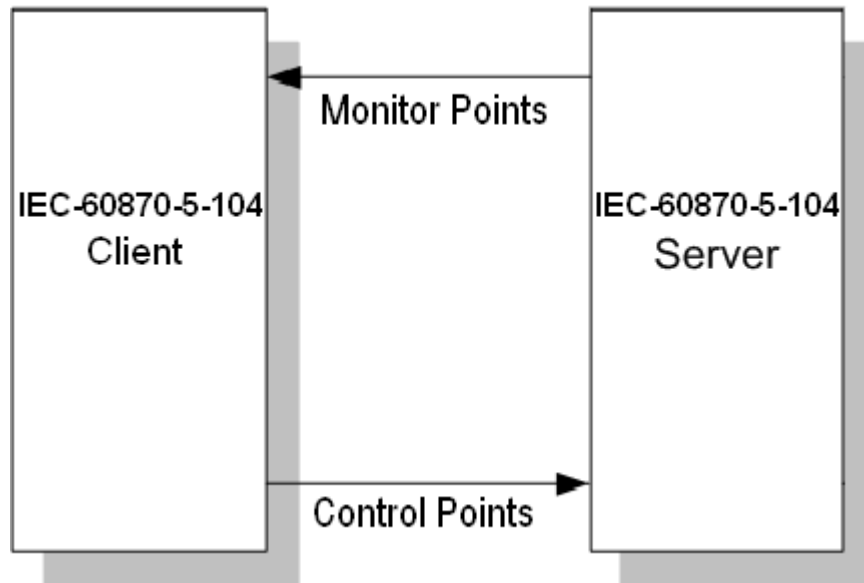

All information objects must be configured in the correct location in the 104C Module database in order to be properly updated by other parts of the application. Keep the data types separated by configuring the Control information objects and Monitor information objects in separate areas of the 104C Module database. The following illustration shows an example configuration:

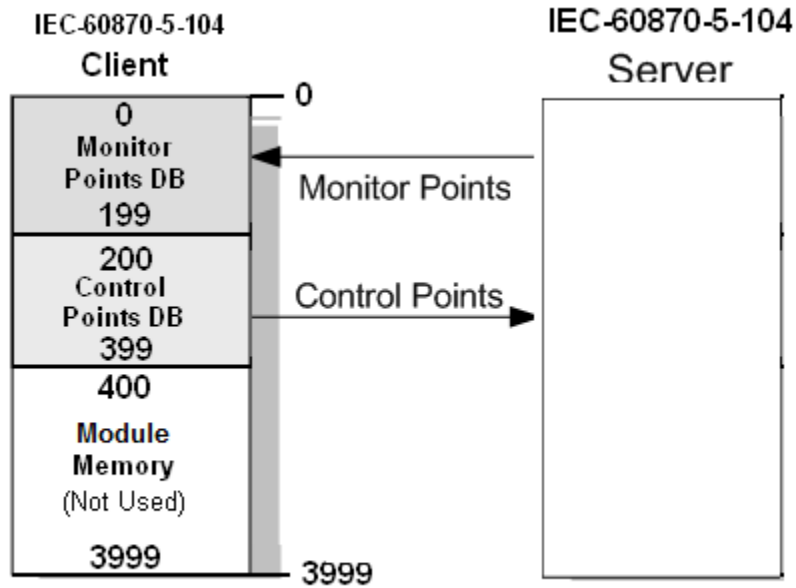

In this example, all Monitor information objects are located between database addresses 0 and 199, and all Control information objects are located between address 200 and 399.

3.3 Using Monitor Points

The following monitor points are supported by the 104C Module gateway:

Symbol	Description	Data Size in Database	Addressing Type
M_SP_NA	Monitored Single-Points	1 bit	Bit
M_DP_NA	Monitored Double-Points	2 bits	Bit
M_ST_NA	Monitored Step Position Points	1 byte	Byte
M_BO_NA	Monitored 32-Bit Bitstring Points	2 words	Double word
M_ME_NA	Monitored Normalized Measured Points	1 word	Word
M_ME_NB	Monitored Scaled Measured Points	1 word	Word
M_ME_NC	Monitored Short Floating-Point Measured Points	2 words	Double word
M_IT_NA	Monitored Integrated Totals	2 words	Double word

Each monitor point is identified by its Information Object Address or Point # Index (it should be unique for each Common ASDU Address in the network). For each monitor point, configure the following parameters:

Point # - The information object address of the point. It identifies the point in the network.

DB Address - The database location in the 104C Module gateway associated with the point. You must associate each point to a database address in the 104C Module gateway. The interpretation of this parameter depends on the point type configured. For example, for an M_SP_NA point, this value represents the bit address. For a M_ME_NA point, this value represents the word address.

3.3.1 Monitor Information Objects Addressing

As discussed before, the Monitor information objects must be configured in a database area in the 104C Module gateway.

The Monitor ASDUs are described in the following table.

ASDU Type	Data Size	Addressing Type
M_SP_NA	1 bit	Bit
M_DP_NA	2 bits	Bit
M_ST_NA	1 byte	Byte
M_BO_NA	2 words	Double word
M_ME_NA	1 word	Word
M_ME_NB	1 word	Word
M_ME_NC	2 words	Double word
M_IT_NA	2 words	Double word

M SP NA

A *Monitor Single-Point* information object occupies one binary bit and uses bit addressing. For example, if you configured the following information objects as shown:

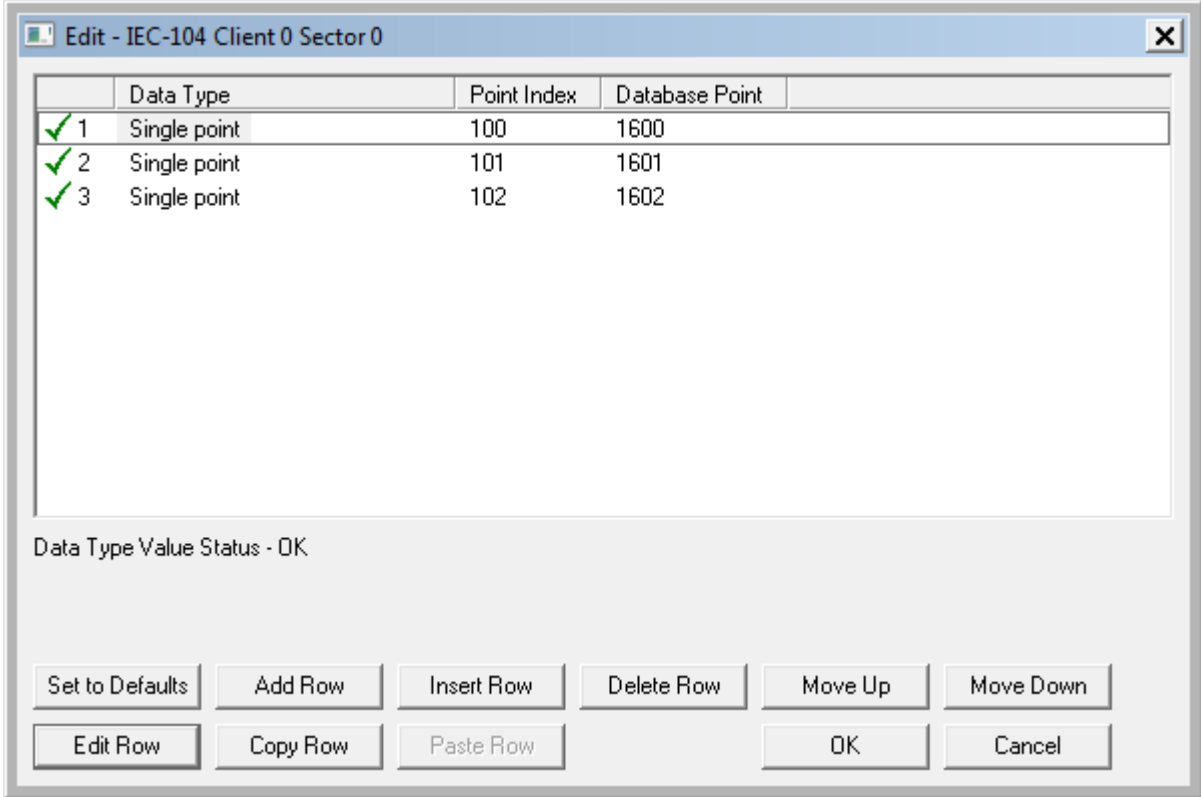

The following table describes how these information objects would be stored in the gateway:

Inf. Object Address	Module Database Address
100	Bit 0 of word 100 (Bit address 1600)
101	Bit 1 of word 100 (Bit address 1601)
102	Bit 2 of word 100 (Bit address 1602)

M DP NA

A *Monitor Double-Point* information object occupies two bits and uses bit addressing. It typically represents the ON/OFF states where:

00 = Undefined or invalid

01 = OFF

10 = ON

11 = Undefined or invalid

If you configured the following information objects as shown:

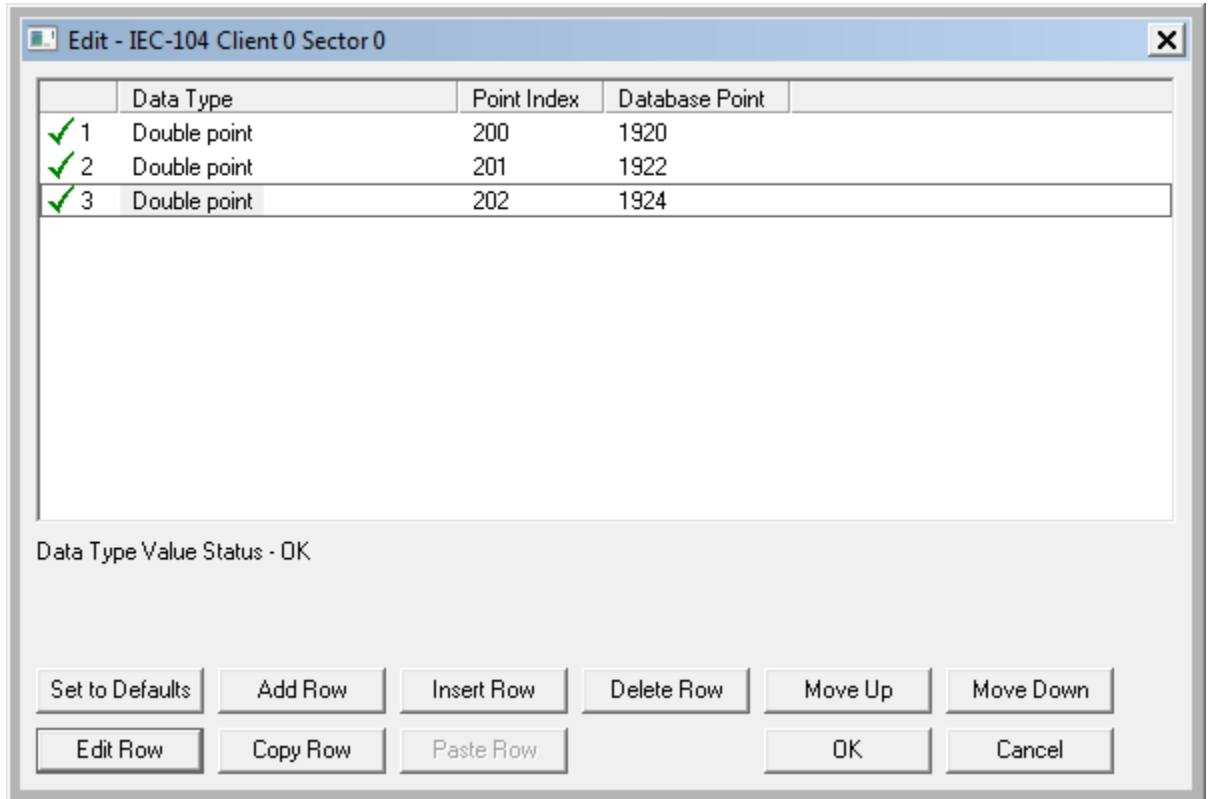

The following table describes how these information objects would be stored in the gateway memory database.

Inf. Object Address	Module Database Address
200	Bit 0 & 1 of word 120 (Bit address 1920 & 1921)
201	Bit 2 & 3 of word 120 (Bit address 1922 & 1923)
202	Bit 4 & 5 of word 120 (Bit address 1924 & 1925)

M ST NA

A *Monitor Step Position* information object occupies one byte and uses byte addressing.

For example, if you configured the following information objects:

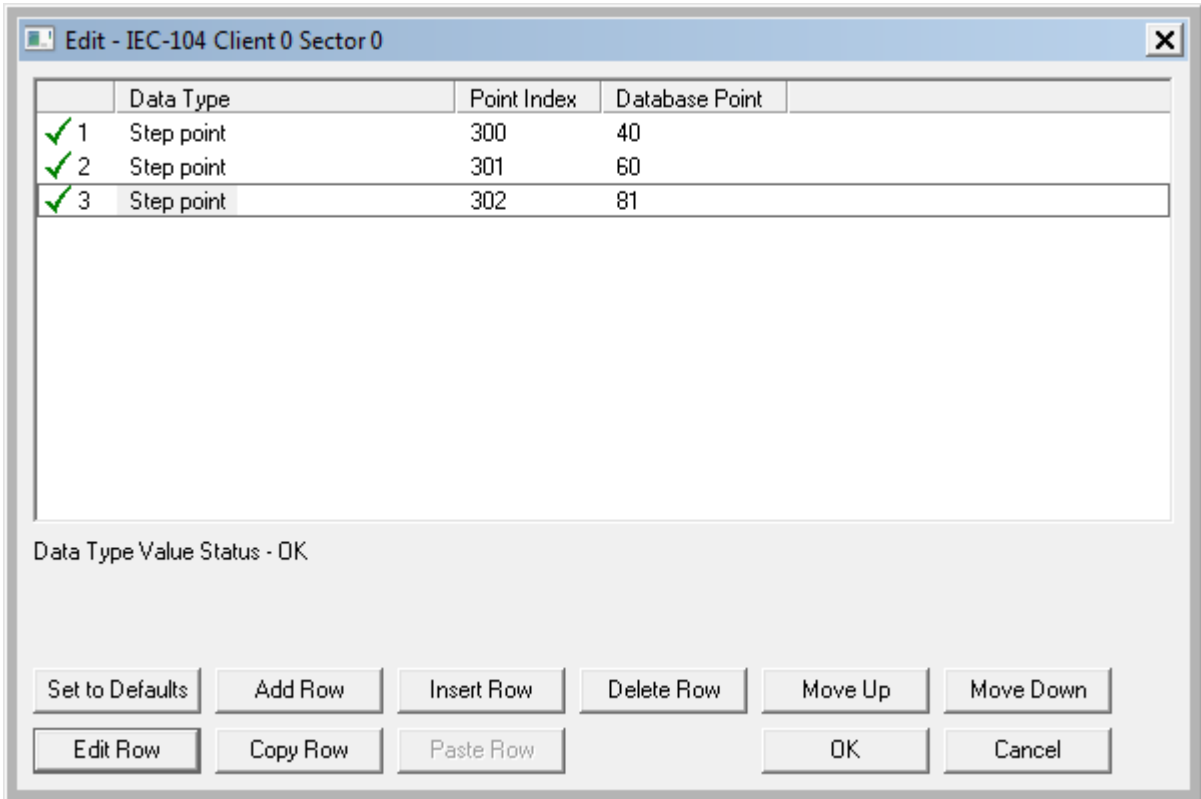

The following table describes how these information objects would be stored in the gateway.

Inf. Object Address	Module Database Address
300	Low byte of word 20 (Byte address 40)
301	Low byte of word 30 (Byte address 60)
302	High byte of word 40 (Byte address 81)

M BO NA

A *Monitor 32-Bit Bitstring* information object occupies two words and uses double-word addressing.

For example, if you configured the following information objects:

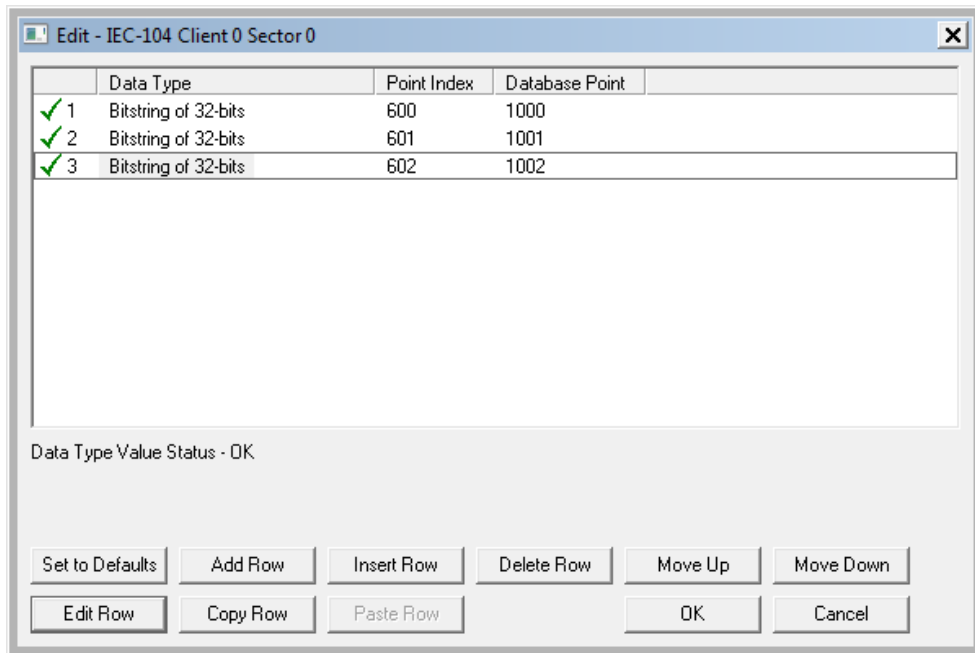

The following table describes how these information objects would be stored in the gateway memory database.

Inf. Object Address	Module Database Address
600	Words 2000 and 2001 (Double-word address 1000)
601	Words 2002 and 2003 (Double-word address 1001)
602	Words 2004 and 2005 (Double-word address 1002)

M ME NA and M ME NB

A *Monitor Normalized Measured* information object or *Monitor Scaled Measured* information object occupies one word and uses word addressing.

For example, if you configured the following information objects:

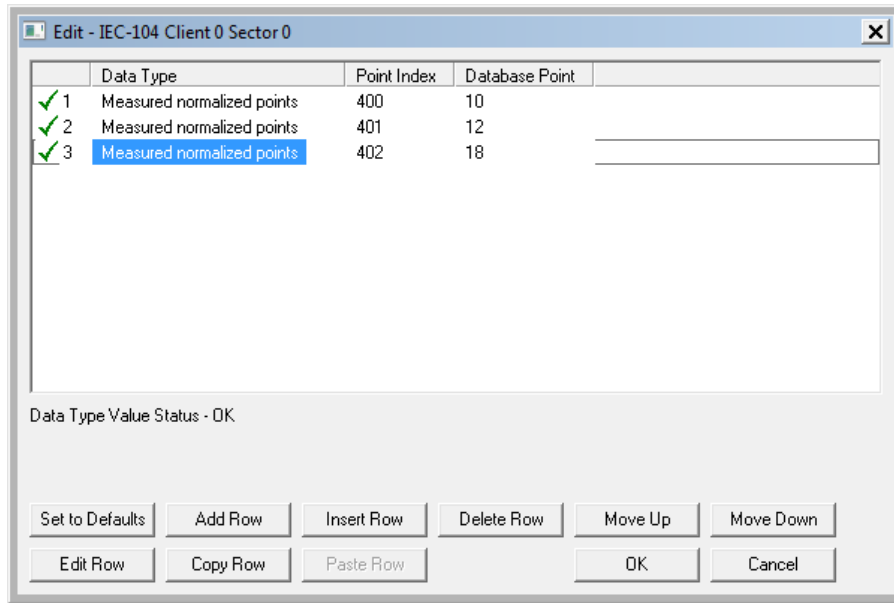

The following table describes how these information objects would be stored in the gateway.

Inf. Object Address	Module Database Address
400	Word 10 (Word address 10)
401	Word 12 (Word address 12)
402	Word 18 (Word address 18)

Monitor Normalized Measured information objects use a data representation defined by the protocol specification to represent fractional decimal values. The following table describes the value for each bit as a reciprocal power of two (2), that is two (2) raised to the power of a negative exponent (-1 through -15). Bit 15 is the Sign Bit.

Bit	15	14	13	12	11	10	9	8	7	6	5	4	3	2	1	0
Value																
Hex(h)	Sign	4000h	2000h	1000h	800h	400h	200h	100h	80h	40h	20h	10h	8h	4h	2h	1h
Decimal		2^{-1}	2^{-2}	2^{-3}	2^{-4}	2^{-5}	2^{-6}	2^{-7}	2^{-8}	2^{-9}	2^{-10}	2^{-11}	2^{-12}	2^{-13}	2^{-14}	2^{-15}
4000h 0.5	0	1	0	0	0	0	0	0	0	0	0	0	0	0	0	0
2000h 0.25	0	0	1	0	0	0	0	0	0	0	0	0	0	0	0	0
1000h 0.125	0	0	0	1	0	0	0	0	0	0	0	0	0	0	0	0
6000h 0.75	0	1	1	0	0	0	0	0	0	0	0	0	0	0	0	0
3210h 0.395751953125	0	0	1	1	0	0	1	0	0	0	0	1	0	0	0	0

Examples:

A value of 4000hex (only Bit 14 set, all others clear) is interpreted as 0.5 decimal

A value of 2000hex (only Bit 13 set, all others clear) is interpreted as 0.25 decimal

A value of 1000hex (only Bit 12 set, all others clear) is interpreted as 0.125 decimal

... and so on until...

A value of 0001hex (Only Bit 0 set, all others clear) is interpreted as 0.000030517578125

Therefore, the actual data values transmitted may be any combination of the decimal values for any given bit pattern.

M ME NC and M IT NA

The *Monitor Short Floating-Point Measured Value* and *Monitor Integrated Totals* information objects occupy two words with double-word addressing.

For example, if you configured the following information objects:

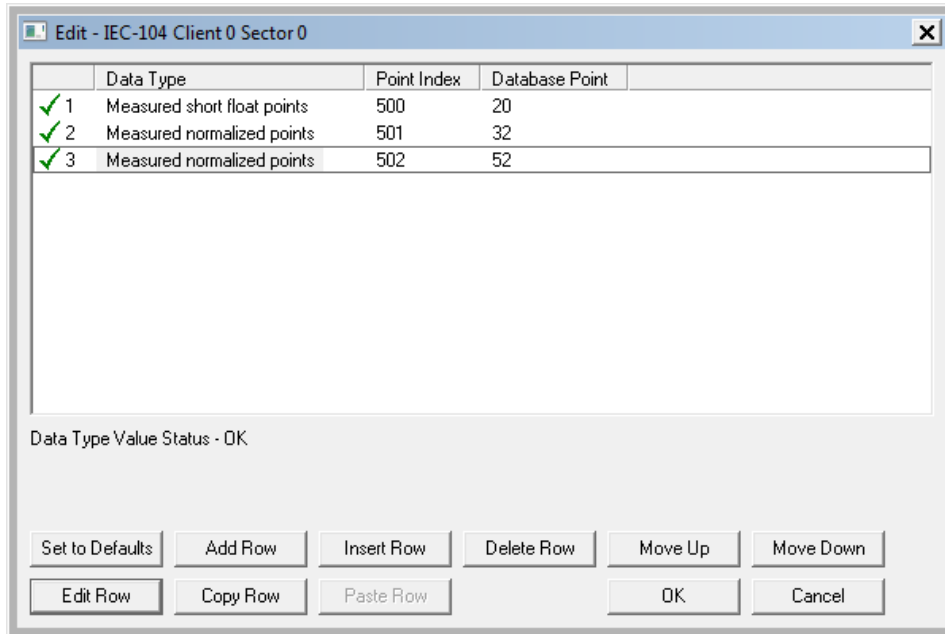

The following table describes how these information objects would be stored in the gateway.

Inf. Object Address	Module Database Address
500	Words 40 and 41 (Double-word address 20)
501	Words 64 and 65 (Double-word address 32)
502	Word 104 and 105 (Double-word address 52)

3.4 Using Control (Command) Information Objects

In order to configure the control points please refer to the Client Command section. Refer to section 2.1.6 for further information about each command field.

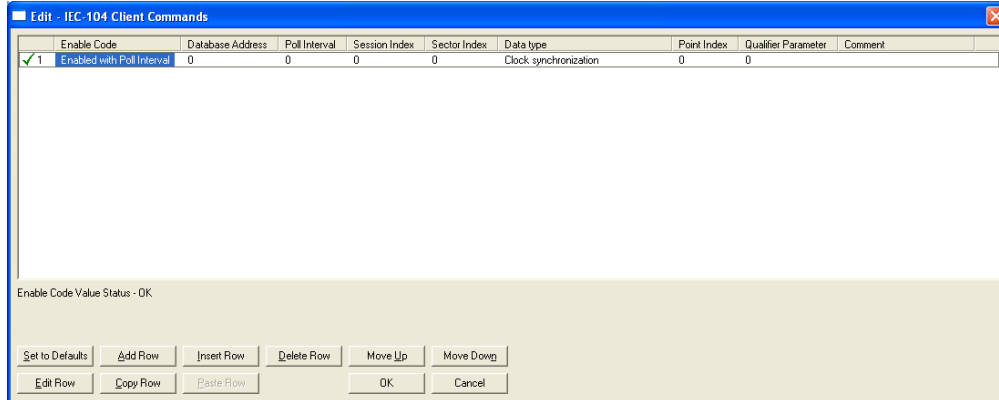

The 104C gateway supports the following Control information objects for data transfer:

ASDU Type	Information Object Description
C_SC_NA	Control Single Command
C_DC_NA	Control Double Command
C_RC_NA	Control Regulating Step Command
C_BO_NA	Control 32-Bit Bitstring Command
C_SE_NA	Control Normalized Value Set Point Command
C_SE_NB	Control Scaled Value Set Point Command
C_SE_NC	Control Short Floating-Point Value Set Point Command

In addition to these the module also supports generic commands to request specific tasks from the remote server such as clock synchronization.

Each Control information object is identified by its Information Object Address. For each Control information object, configure the following parameters:

Point Index - This is the Information Object Address of the information object. It identifies the information object in the network. This address must be unique for each sector (Common ASDU Address) in the network.

DB Address - This is the database location in the 104C v3 gateway associated with the information object. The database address interpretation may be bit-address, byte-address, word-address, double-word-address depending on the ASDU type. Refer to the following section for further information:

3.4.1 Control Information Objects Addressing

You must associate each control information object to a database address in the gateway. The interpretation of the DB Address parameter in the configuration tables depends on the ASDU configured and the type of addressing associated with that ASDU.

ASDU Type	Data Size	Addressing Type
C_SC_NA	1 bit	Bit
C_DC_NA	2 bits	Bit
C_RC_NA	1 byte	Byte
C_BO_NA	2 words	Double word
C_SE_NA	1 word	Word
C_SE_NB	1 word	Word
C_SE_NC	2 words	Double word

C SC NA

A *Control Single Command* information object occupies one bit and uses bit addressing. For example, if you configure the following information objects:

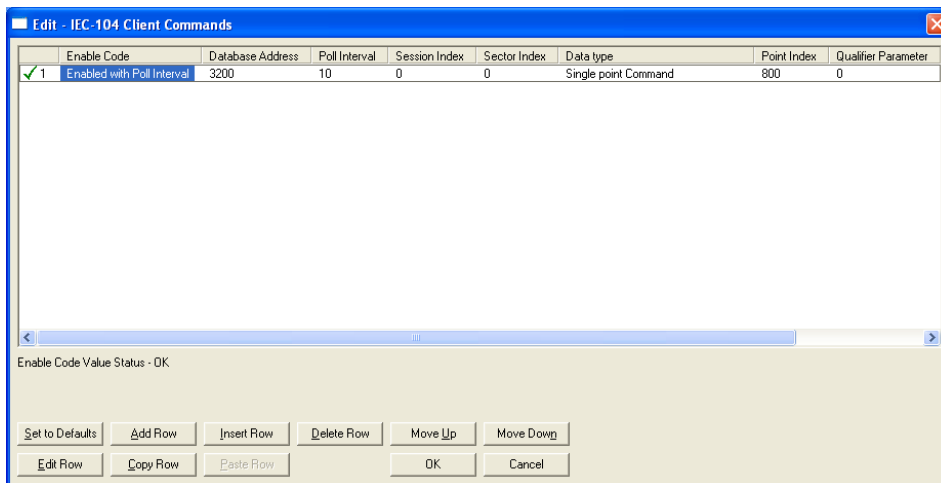

These information objects would be used as follows:

Inf. Object Address	Module Database Address
800	Bit 0 of word 200 to hold the Control bit (Bit address 3200)

C DC NA

A *Control Double Command* information object occupies two bits and uses bit addressing. For example, if you configure the following information objects:

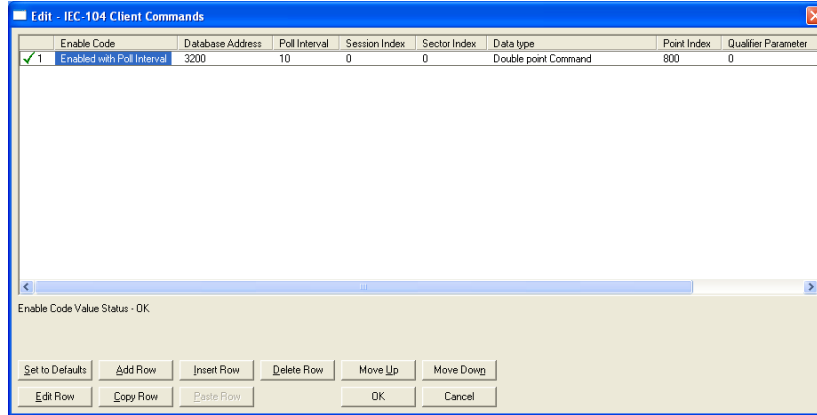

These information objects would be used as follows:

Inf. Object Address	Module Database Address
800	Bits 0 and 1 of word 200 to hold the Control bits (Bit addresses 3200 and 3201)

C RC NA

A *Control Regulating Step Command* information object occupies one byte and uses byte addressing.

For example, if you configured the following information objects:

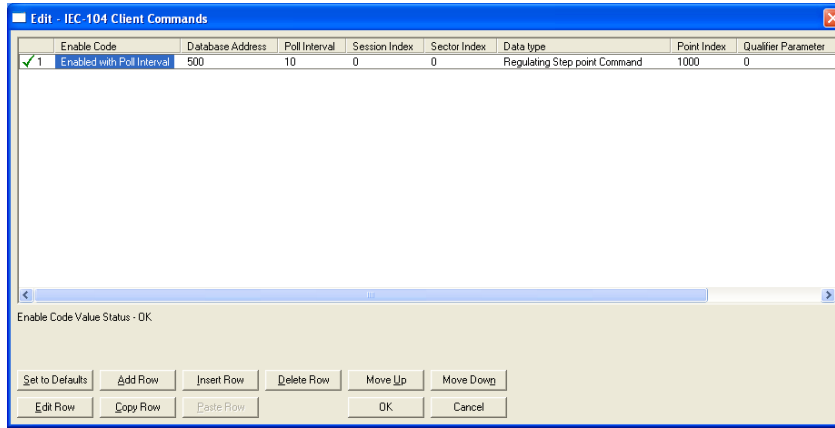

The following table describes how these information objects would be stored in the module database.

Inf. Object Address	Module Database Address
1000	Low Byte of word 250 (Byte address 500)

C BO NA

A *Control 32-Bit Bitstring Command* information object occupies two words and uses double-word addressing.

For example, if you configured the following information objects:

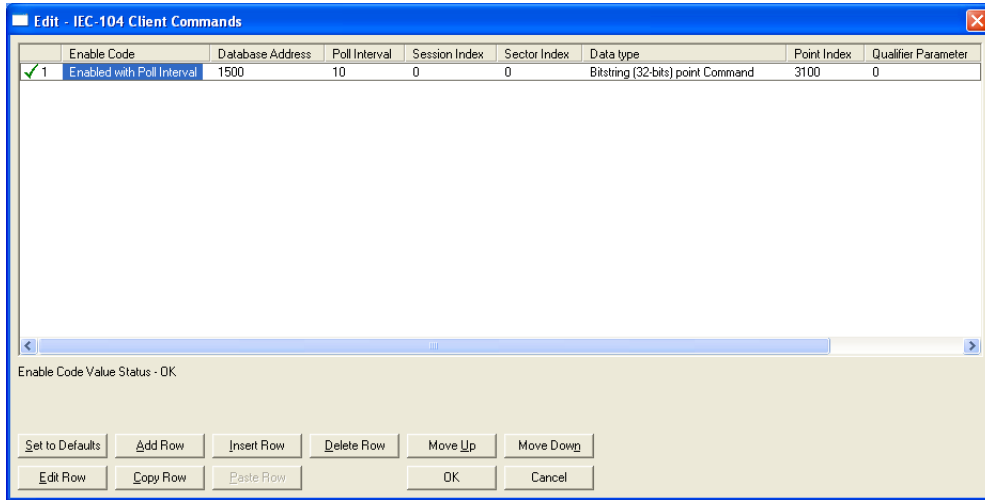

These information objects would be used as follows:

Inf. Object Address	Module Database Address
3100	Words 3000 and 3001 (Double-word address 1500)

C SE NA and C SE NB

The *Control Normalized Value Set Point Command* information object and the *Control Scaled Value Set Point Command* information object use one word with word addressing. For example, if you configured the following information objects:

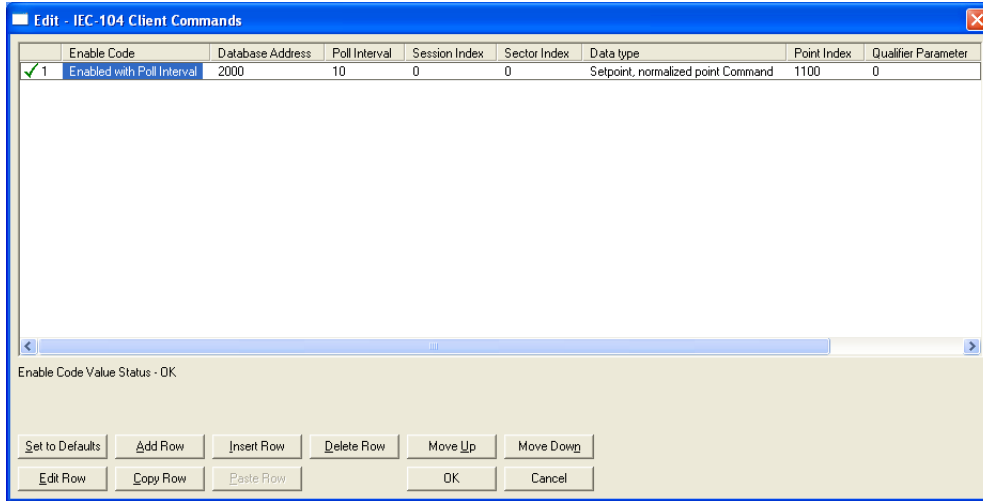

The following table describes how these information objects would be used.

Inf. Object Address	Module Database Address
1100	Word 2000 (Word address 2000)

The *Control Normalized Measured* information objects use a data representation defined by the protocol specification to represent fractional decimal values. The following table describes the value for each bit as a reciprocal power of two (2), that is two (2) raised to the power of a negative exponent (-1 through -15). Bit 15 is the Sign Bit.

Bit	15	14	13	12	11	10	9	8	7	6	5	4	3	2	1	0
Value	Sign	4000h	2000h	1000h	800h	400h	200h	100h	80h	40h	20h	10h	8h	4h	2h	1h
Hex(h)		2 ⁻¹	2 ⁻²	2 ⁻³	2 ⁻⁴	2 ⁻⁵	2 ⁻⁶	2 ⁻⁷	2 ⁻⁸	2 ⁻⁹	2 ⁻¹⁰	2 ⁻¹¹	2 ⁻¹²	2 ⁻¹³	2 ⁻¹⁴	2 ⁻¹⁵
Decimal																
4000h 0.5	0	1	0	0	0	0	0	0	0	0	0	0	0	0	0	0
2000h 0.25	0	0	1	0	0	0	0	0	0	0	0	0	0	0	0	0
1000h 0.125	0	0	0	1	0	0	0	0	0	0	0	0	0	0	0	0
6000h 0.75	0	1	1	0	0	0	0	0	0	0	0	0	0	0	0	0
3210h 0.395751953125	0	0	1	1	0	0	1	0	0	0	0	1	0	0	0	0

Examples:

A value of 4000hex (only Bit 14 set, all others clear) is interpreted as 0.5 decimal

A value of 2000hex (only Bit 13 set, all others clear) is interpreted as 0.25 decimal

A value of 1000hex (only Bit 12 set, all others clear) is interpreted as 0.125 decimal

... and so on until...

A value of 0001hex (Only Bit 0 set, all others clear) is interpreted as 0.000030517578125

Therefore, the actual data values transmitted may be any combination of the decimal values for any given bit pattern.

C SE NC

A *Control Short Floating-Point Value Set Point Command* information object occupies two words and uses double-word addressing.

For example, if you configured the following information objects:

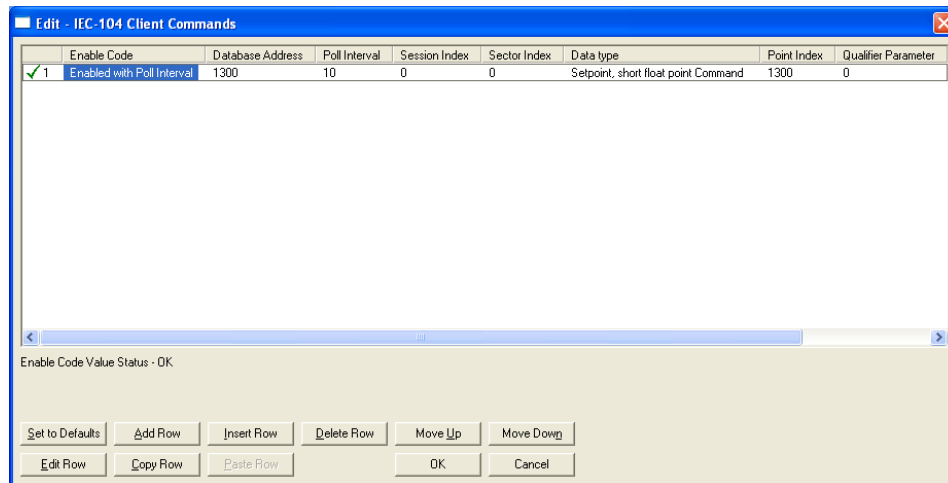

The following table describes how these information objects would be stored in the gateway:

Inf. Object Address	Module Database Address
1300	Words 2600 and 2601 (Double-word address 1300)

3.4.2 TESTFR Requests

Connections that are unused (but opened) may be periodically tested in both directions by sending test messages (TESTFR=act), which are confirmed by the receiving station sending TESTFR=con messages. The gateway can be configured to periodically send this message using the following parameter:

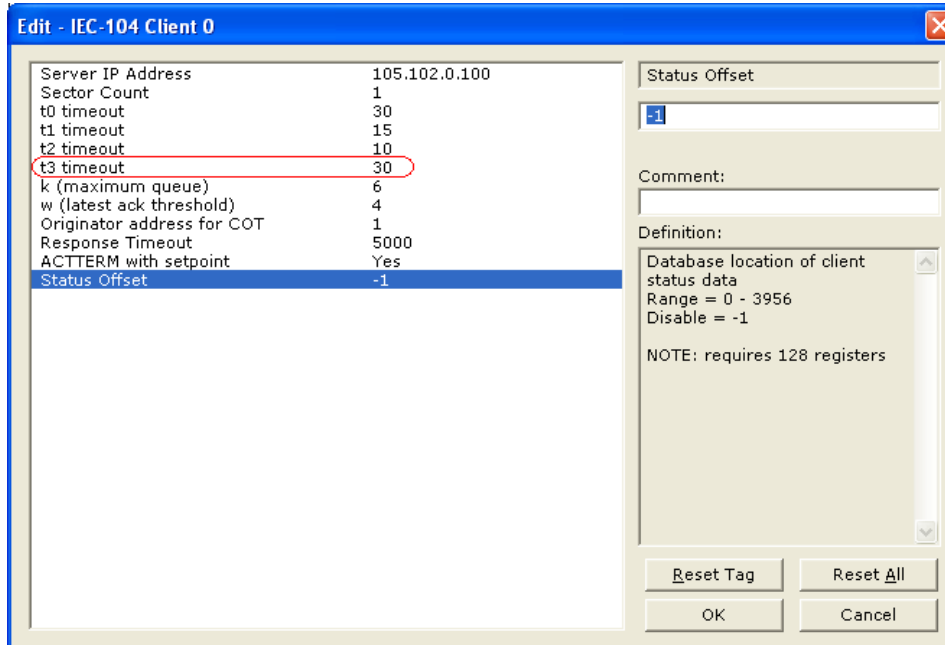

In the example above, the gateway would send a TESTFR.ACT message 30 seconds after receiving the last message:

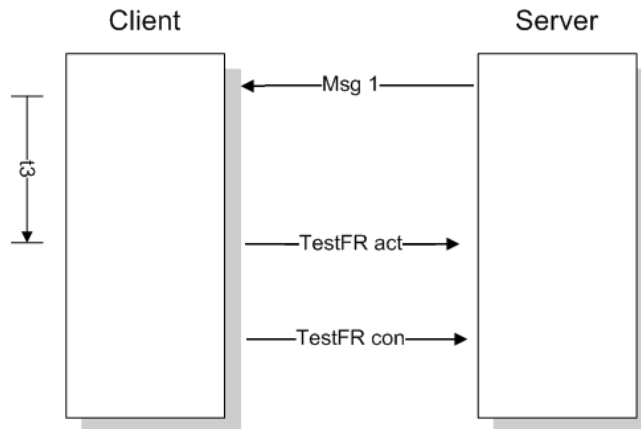

If the gateway does not receive the TESTFR.con message within a certain amount of time, it will time out and close the connection. You can configure the timeout period using the following parameter:

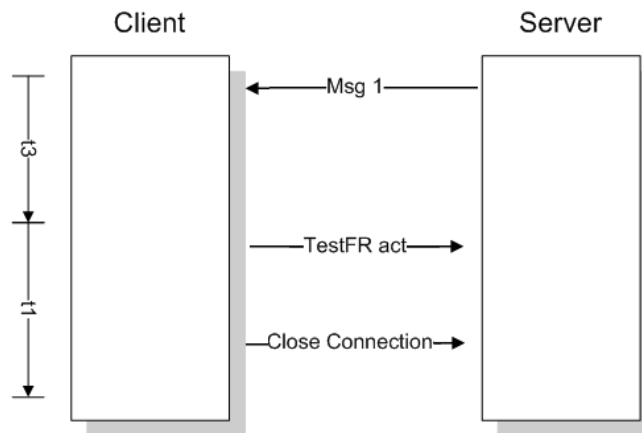
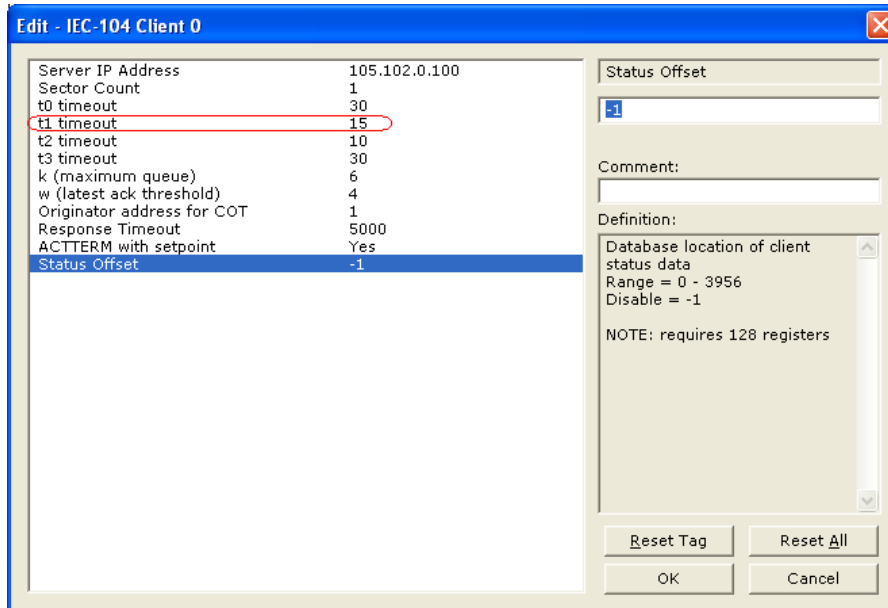

4 Mailbox Feature (x201-DFNT-104C)

In This Chapter

❖ User Constructed Command Mailbox (9901)	70
❖ Command Control Block Mailbox (9902)	72
❖ Event Messages from Outstations Mailbox (9903)	73
❖ General Gateway Status Mailbox (9250)	76
❖ Client X Status Data Mailbox (9251)	78
❖ Command List Error Data Mailbox (9950)	81
❖ Get Gateway Time Mailbox (9970)	83
❖ Set Gateway Time Mailbox (9971)	85
❖ Reset Status Data Mailbox (9997)	87
❖ Coldboot Mailbox (9998/9999)	88

The 5201-DFNT-104C module supports the mailbox feature. It allows the Ethernet/IP (DFNT) remote device to request specific tasks from the module by writing a data block request to the module database. The module will perform the request and then update the mailbox response area in the database.

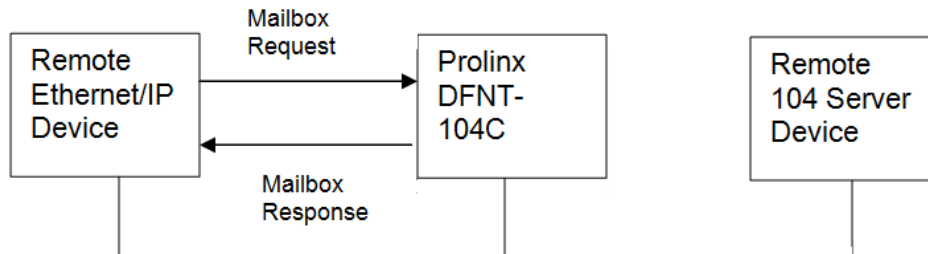

The start of the mailbox area is configured through the Mailbox Offset parameter in the IEC-104 Client Module section as follows:

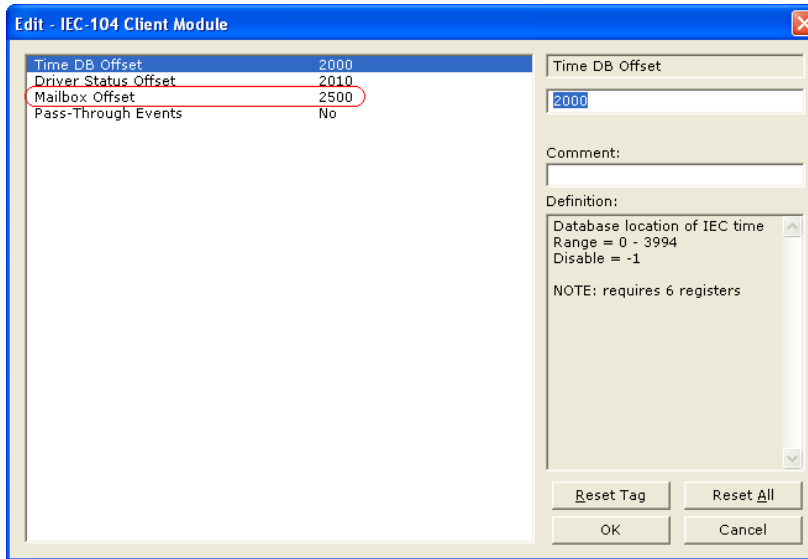

The mailbox area requires a 128-word database area. The first 64 words are used for the mailbox request area received from the remote Ethernet/IP device. The last 64 words are reserved for the mailbox response built by the gateway module. So for the example above:

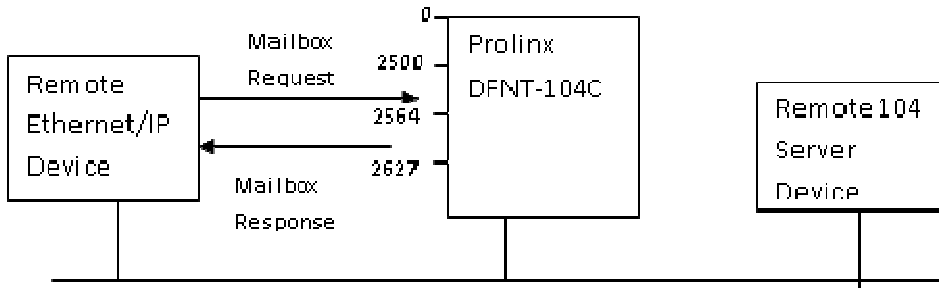

In the mailbox request area the first and last words are reserved for the mailbox ID. Once the module recognizes a new mailbox ID (same mailbox ID) into these registers it will process the mailbox request starting from the second register:

Offset	Description
0	Mailbox ID
1	Start of mailbox request
...	...
62	End of mailbox request
63	Mailbox ID

The same applies for the mailbox response. The module builds the mailbox response and updates the mailbox ID according to the originating request:

Offset	Description
0	Mailbox ID
1	Start of mailbox response
...	...
62	End of mailbox response
63	Mailbox ID

The following mailboxes are supported by the module:

Block Range	Descriptions
±9901	User Constructed Command to add to command queue
±9902	Command Control Block (Add command to Command Queue)
±9903	Event Messages from Outstations
±9250	General Module Status
±9251	Client X Status Data
±9950	Command List Error data
±9970	Get 104 client driver's time
±9971	Set 104 client driver's time
±9997	Reset status data
9998	Cold boot Confirmation
9999	Cold Boot Request

The purpose for the mailbox supporting a positive and negative value is so the remote device can trigger consecutive requests for the same mailbox by switching the value between positive and negative. For example, to request 3 consecutive Get Module time the block ID could be switched as +9970, -9970, +9970.

4.1 User Constructed Command Mailbox (9901)

This mailbox allows the remote Ethernet/IP device to dynamically build commands to be sent to the remote 104 server for one time. Up to 10 commands can be built for one block.

Mailbox Request

Word Offset in Block	Data Field(s)	Description
0	Mailbox ID	This field contains the identification code of -9901 or 9901 for the block.
1	Command Count	This field defines the number of user commands contained in the block. The valid range for the field is 1 to 10.
2 to 7	Command #1	Data required to build the user defined command in the command queue.
8 to 13	Command #2	Data required to build the user defined command in the command queue.
14 to 19	Command #3	Data required to build the user defined command in the command queue.
20 to 25	Command #4	Data required to build the user defined command in the command queue.
26 to 31	Command #5	Data required to build the user defined command in the command queue.
32 to 37	Command #6	Data required to build the user defined command in the command queue.
38 to 43	Command #7	Data required to build the user defined command in the command queue.
44 to 49	Command #8	Data required to build the user defined command in the command queue.
50 to 55	Command #9	Data required to build the user defined command in the command queue.
56 to 61	Command #10	Data required to build the user defined command in the command queue.
62	Spare	Not Used
63	Mailbox ID	This field contains the identification code of -9901 or 9901 for the block.

The following fields are used for each word record in the command list:

Word Offset	Definitions	Description
0	Database Index	Address in module to associate with the command
1	Session Index	Session index defined in the module to associate with the command (0 to 3).
2	Sector Index	Sector index for session as defined in the module (0 or 1).
3	Data Type	ASDU data type associated with the command.
4	Point Index	Information object address for the point on which command operates.
5	Qualifier	Qualifier as defined for the command list. This parameter is data type dependent.

Mailbox Response

Word Offset in Block	Data Field(s)	Description
0	Mailbox ID	This field contains the identification code of -9901 or 9901 for the block.
1	Command Count	This field defines the number of user commands added to the command queue
2 to 62	Spare	Not Used
63	Mailbox ID	This field contains the identification code of -9901 or 9901 for the block.

4.2 Command Control Block Mailbox (9902)

This mailbox allows the remote Ethernet /IP device to dynamically enable for one time a 104C configured command that is disabled. Up to 60 commands can be enabled simultaneously in one block.

Mailbox Request

Word Offset in Block	Data Field(s)	Description
0	Mailbox ID	This field contains the value of -9902 or 9902 identifying the enable command to the module.
1	Command count	This field contains the number of commands to enable in the command list. Valid values for this field are 1 to 60.
2 to 61	Command Numbers to enable	These 60 words of data contain the command numbers in the command list to enable. The commands in the list will be placed in the command queue for immediate processing by the module. The first command in the list has an index of 0.
62	Spare	Not Used
63	Mailbox ID	This field contains the value of -9902 or 9902 identifying the enable command to the module.

Mailbox Response

Word Offset in Block	Data Field(s)	Description
0	Mailbox ID	This field contains the value of -9902 or 9902 identifying the enable command to the module.
1	Command count	This field contains the number of commands added to the command queue.
2 to 62	Spare	Not Used
63	Mailbox ID	This field contains the value of -9902 or 9902 identifying the enable command to the module.

4.3 Event Messages from Outstations Mailbox (9903)

Mailbox ±9903 is used to request event messages received by the client driver from outstations. In order to use this feature you must enable Pass-Through Events parameter in the IEC-104 Client Gateway section.

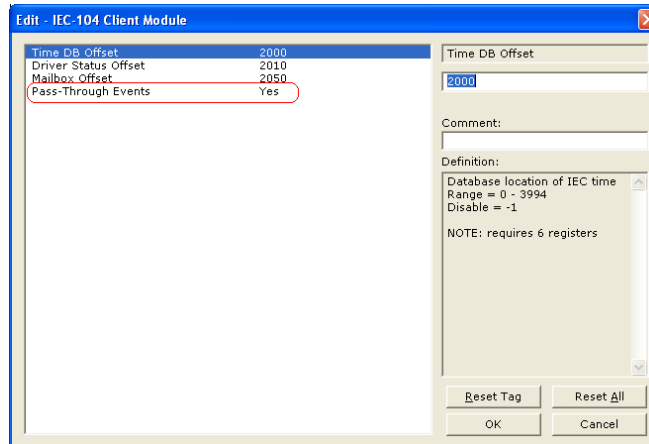

Mailbox Request

Word Offset in Block	Data Field(s)	Description
0	Mailbox ID	This field contains the value of -9903 or 9903 identifying the block type to the module.
1 to 62	Not Used	Not Used
63	Mailbox ID	This field contains the value of -9903 or 9903 identifying the block type to the module.

Mailbox Response

Word Offset in Block	Data Field(s)	Description
0	Mailbox ID	This field contains the value of -9903 or 9903 identifying the block type to the module.
1	Event Count	This field contains the number of events present in the block. Values of 0 to 4 are valid.
2 to 15	Event 1	Event message
16 to 29	Event 2	Event message
30 to 43	Event 3	Event message
44 to 57	Event 4	Event message
58 to 60	Spare	Not Used
61	Event Count Remaining	Number of events still present in the event queue after removing these events.
62	Event Overflow	This flag will be set if the event buffer overflowed since last reported.
63	Mailbox ID	This field contains the value of -9903 or 9903 identifying the block type to the module.

The format of each 14 word data region in the block is as follows:

Word Offset	Definitions	Description
0	Session Index	This field contains the session index used to define the controlled unit in the module from which the event was generated.
1	Sector Index	This field contains the sector index used to define the database within the controlled unit from which the event was generated.
2	COT	This field contains the COT for the event message received from the IED. If the size of the COT is a single byte, the originator address will always be zero. The COT is in the LSB and the originator address is in the MSB.

3	Reserved	This field is reserved for future use and is added here to keep the structure double-word aligned for all platforms.
4 to 5	Point Index	This field contains the point index in the remote device that generated the event.
6	ASDU Type	This field contains the ASDU type code for the data contained in the message.
7	Milliseconds and Seconds	This word contains the seconds and milliseconds when the event occurred.
8	Minutes and Hours	This field contains the minutes and hours the event occurred.
9	Month and Day	This field contains the month and day of the month the event occurred.
10	Year	This field contains the year the event occurred.
11	Qualifier	This field contains the point qualifier, quality or sequence value as described in the protocol specification.
12 to 13	Value	This field contains the a double word value for the point associated with the event message.

4.4 General Gateway Status Mailbox (9250)

This mailbox requests the general gateway status

Mailbox Request

Word Offset in Block	Data Field(s)	Description
0	Mailbox ID	This field contains the value of -9250 or 9250 identifying the block type to the module.
1 to 62	Not Used	Not Used
63	Mailbox ID	This field contains the value of -9250 or 9250 identifying the block type to the module.

Mailbox Response

Word Offset in Block	Data Field(s)	Description
0	Mailbox ID	This field contains the value of -9250 or 9250 identifying the block type to the module.
1 to 62	General status data	General status data
63	Mailbox ID	This field contains the value of -9250 or 9250 identifying the block type to the module.

The general status data has the following format:

OFFSET	PARAMETER
0	Event Msg Cnt
1	Event Msg Overflow
2	Session Count
3	Current Cmd
4	Cmd Busy Flag
5	Cmd Count
6	Cmd Delay
7	Cmd Queue
8	Cmd Queue Count
9 to 10	Online Status
11	Spare
12	SNTP Valid
13	NTP Request
14	NTP Response
15	SNTP Computation
16	SNTP Set
17	NTP Timeout

4.5 Client X Status Data Mailbox (9251)

This mailbox allows the Ethernet/IP remote device to request a 104 Client status data from the module.

Mailbox Request

Word Offset in Block	Data Field(s)	Description
0	Mailbox ID	This field contains the value of -9251 or 9251 identifying the block type to the module.
1 to 62	Client ID	Client number (0-3)
2 to 62	Not Used	Not Used
63	Mailbox ID	This field contains the value of -9251 or 9251 identifying the block type to the module.

Mailbox Response

Word Offset in Block	Data Field(s)	Description
0	Mailbox ID	This field contains the value of -9251 or 9251 identifying the block type to the module.
1 to 62	Client X status data	General status data
63	Mailbox ID	This field contains the value of -9251 or 9251 identifying the block type to the module.

Mailbox 9251 – Client X Status Area

OFFSET	PARAMETER	DESCRIPTION
0	Active	Active status of client 0 = not active 1 = waiting on StartDT con 2 = Online (StartDT con received)
1	State	State of Client Socket: -255 = Idle until processor in run -1 = Ready for socket open 0 = Waiting for socket establish 1 = Read and write data to socket (process data) 70 = Sending StartDT act 80 = Sending StopDT act 100 = End program/close socket 1000 = Close socket (start 2-second timeout) 1001 = Wait for close & abort if timeout 2000 = ARP request/response 2001 = Open Socket
2	Open Count	Number of times socket open attempted
3	Close Count	Number of times socket closed
4	Connect Count	Number of times socket established
5-14	Host IP	ASCII string of remote server IP address (10 words)
15	t0 Timeouts	Number of t0 timeouts
16	t1 Timeouts	Number of t1 timeouts
17	t2 Timeouts	Number of t2 timeouts
18	t3 Timeouts	Number of t3 timeouts
19	Sequence Errors	Number of sequence errors
20	Bad Address Errors	Number of bad address errors
21	Length Errors	Number of length errors
22	Rx Frame Count	Number of frames received on socket
23	Tx Frame Count	Number of frames transmitted on socket
24	Cmd Requests	Number of commands issued from command list and queue
25	Cmd Responses	Number of responses to commands issued from command list and queue.
26	Cmd Error Count	Number of errors recognized when issued from command list or queue
27	Requests	Number of requests from command driver
28	Responses	Number of messages received by command driver
29	Errors Sent	Number of errors sent by command driver (not used)
30	Errors Received	Number of errors received by command driver
31	Configuration Error	Configuration error word for client
32	Current Error	Current error recognized
33	Last Error	Last error recognized

34	Send Number	Send sequence number
35	Rec Number	Received sequence number
36	Ack Number	Last acknowledged sequence number
37	Queue Max	Maximum number of queue (k)
38	Queue Threshold	Queue threshold before S-Frame sent (w)
39	Rec Packets	Number of I-frames received but not acknowledged
40	Queue Now	Number of messages in queue
41	Queue First	First index of message in queue
42	Queue Index	Current index of message in queue
43	Spare	Reserved for future use

4.6 Command List Error Data Mailbox (9950)

Mailbox ± 9950 identification code is used to request the Command List Error Table from the module. The format for the block is shown below:

Mailbox Request

Word Offset in Block	Data Field(s)	Description
0	Mailbox ID	This field contains the value of -9950 or 9950 identifying the block type to the module.
1	Number of Commands to report	This field contains the number of commands to report in the response message. The value has a range of 1 to 60.
2	Start Index of First Command	This parameter sets the index in the command list where to start. The first command in the list has a value of 0. The last index in the list has a value of MaxCommands - 1.
3 to 62	Spare	Not Used
63	Mailbox ID	This field contains the value of -9950 or 9950 identifying the block type to the module.

Mailbox Response

Word Offset in Block	Data Field(s)	Description
0	Mailbox ID	This field contains the value of -9950 or 9950 identifying the block type to the module.
1	Number of Commands reported	This field contains the number of commands contained in the block that need to be processed by the PLC. This field will have a value of 1 to 60.
2	Start Index of First Command	This field contains the index in the command list for the first value in the file. This field will have a value of 0 to MaxCommands-1.
3 to 62	Command List Errors	Each word of this area contains the last error value recorded for the command. The command index of the first value (offset 4) is specified in word 3 of the block. The number of valid command errors in the block is set in word 2 of the block. Refer to the command error list to interpret the error codes reported.
63	Mailbox ID	This field contains the value of -9950 or 9950 identifying the block type to the module.

4.7 Get Gateway Time Mailbox (9970)

Mailbox ± 9970 identification code is used to request the IEC 104 client driver date and time.

Mailbox Request

Word Offset in Block	Data Field(s)	Description
0	Mailbox ID	This field contains the value of -9970 or 9970 identifying the block type to the module.
1 to 62	Not Used	Not Used
63	Mailbox ID	This field contains the value of -9970 or 9970 identifying the block type to the module.

Response to a block 9970 request -- The module will respond to a valid block 9970 request with a block containing the requested date and time. The format for the block is shown below:

Mailbox Response

Word Offset in Block	Data Field(s)	Description
0	Mailbox ID	This field contains the value of -9970 or 9970 identifying the block type to the module.
1	Year	This field contains the four-digit year to be used with the new time value.
2	Month	This field contains the month value for the new time. Valid entry for this field is in the range of 1 to 12.
3	Day	This field contains the day value for the new time. Valid entry for this field is in the range of 1 to 31.
4	Hour	This field contains the hour value for the new time. Valid entry for this field is in the range of 0 to 23.
5	Minute	This field contains the minute value for the new time. Valid entry for this field is in the range of 0 to 59.
6	Seconds	This field contains the second value for the new time. Valid entry for this field is in the range of 0 to 59.
7	Milliseconds	This field contains the millisecond value for the new time. Valid entry for this field is in the range of 0 to 999.
8 to 62	Not Used	Not Used
63	Mailbox ID	This field contains the value of -9970 or 9970 identifying the block type to the module.

4.8 Set Gateway Time Mailbox (9971)

Mailbox identification code ±9971 is used to pass the date and time to the module. The date and time provided will be used to set the 104 client drivers clock.

Mailbox Request

Word Offset in Block	Data Field(s)	Description
0	Mailbox ID	This field contains the block identification code of -9971 or 9971 for the block.
1	Year	This field contains the four-digit year to be used with the new time value.
2	Month	This field contains the month value for the new time. Valid entry for this field is in the range of 1 to 12.
3	Day	This field contains the day value for the new time. Valid entry for this field is in the range of 1 to 31.
4	Hour	This field contains the hour value for the new time. Valid entry for this field is in the range of 0 to 23.
5	Minute	This field contains the minute value for the new time. Valid entry for this field is in the range of 0 to 59.
6	Seconds	This field contains the second value for the new time. Valid entry for this field is in the range of 0 to 59.
7	Milliseconds	This field contains the millisecond value for the new time. Valid entry for this field is in the range of 0 to 999.
8 to 62	Not Used	Not Used
63	Mailbox ID	This field contains the block identification code of -9971 or 9971 for the block.

Mailbox Response

Word Offset in Block	Data Field(s)	Description
0	Mailbox ID	This field contains the block identification code of -9971 or 9971 for the block.
1	Year	This field contains the four-digit year to be used with the new time value.
2	Month	This field contains the month value for the new time. Valid entry for this field is in the range of 1 to 12.
3	Day	This field contains the day value for the new time. Valid entry for this field is in the range of 1 to 31.
4	Hour	This field contains the hour value for the new time. Valid entry for this field is in the range of 0 to 23.
5	Minute	This field contains the minute value for the new time. Valid entry for this field is in the range of 0 to 59.
6	Seconds	This field contains the second value for the new time. Valid entry for this field is in the range of 0 to 59.
7	Milliseconds	This field contains the millisecond value for the new time. Valid entry for this field is in the range of 0 to 999.
8 to 62	Not Used	Not Used
63	Mailbox ID	This field contains the block identification code of -9971 or 9971 for the block.

4.9 Reset Status Data Mailbox (9997)

This mailbox requests the module to reset all status counters

Mailbox Request

Word Offset in Block	Data Field(s)	Description
0	Mailbox ID	This field contains the value of -9997 or 9997 identifying the block type to the module.
1	Reset Module Status	Set a value of 1 to reset the module status
2	Reset Client 1 Status	Set a value of 1 to reset client 1 status
3	Reset Client 2 Status	Set a value of 1 to reset client 2 status
4	Reset Client 3 Status	Set a value of 1 to reset client 3 status
5	Reset Client 4 Status	Set a value of 1 to reset client 4 status
1 to 62	Not Used	Not Used
63	Mailbox ID	This field contains the value of -9997 or 9997 identifying the block type to the module.

Mailbox Response

Word Offset in Block	Data Field(s)	Description
0	Mailbox ID	This field contains the value of -9997 or 9997 identifying the block type to the module.
1 to 62	Reserved	Reserved
63	Mailbox ID	This field contains the value of -9997 or 9997 identifying the block type to the module.

4.10 Coldboot Mailbox (9998/9999)

This mailbox allows the remote device to request a coldboot operation from the module. The request block should contain block ID 9999. Once the module builds the mailbox response block ID 9999 then the remote device should write a block ID 9998 to confirm the acknowledgment.

Coldboot request:

Mailbox Request

Word Offset in Block	Data Field(s)	Description
0	Mailbox ID	This field contains the value of -9999 or 9999 identifying the block type to the module.
1 to 62	Not Used	Not Used
63	Mailbox ID	This field contains the value of -9999 or 9999 identifying the block type to the module.

Mailbox Response

Word Offset in Block	Data Field(s)	Description
0	Mailbox ID	This field contains the value of -9999 or 9999 identifying the block type to the module.
1 to 62	Reserved	Reserved
63	Mailbox ID	This field contains the value of -9999 or 9999 identifying the block type to the module.

Coldboot confirmation:

Mailbox Request

Word Offset in Block	Data Field(s)	Description
0	Mailbox ID	This field contains the value of -9998 or 9998 identifying the block type to the module.
1 to 62	Not Used	Not Used
63	Mailbox ID	This field contains the value of -9998 or 9998 identifying the block type to the module.

Mailbox Response

Word Offset in Block	Data Field(s)	Description
0	Mailbox ID	This field contains the value of -9998 or 9998 identifying the block type to the module.
1 to 62	Reserved	Reserved
63	Mailbox ID	This field contains the value of -9998 or 9998 identifying the block type to the module.

5 Diagnostics and Troubleshooting

In This Chapter

- ❖ Ethernet LED Indicators 92
- ❖ Using ProSoft Configuration Builder (PCB) for Diagnostics..... 93

There are two ways to troubleshoot ProLinx gateways:

- Using the LEDs located on the front of the gateway
- Using the Debug port, which provides a view into the gateway's internal database.

5.1 Ethernet LED Indicators

LED	State	Description
Data	OFF	No activity on the Ethernet port.
	GREEN Flash	The Ethernet port is actively transmitting or receiving data.
Link	OFF	No physical network connection is detected. No Ethernet communication is possible. Check wiring and cables.
	GREEN Solid	Physical network connection detected. This LED must be ON solid for Ethernet communication to be possible.

5.2 Using ProSoft Configuration Builder (PCB) for Diagnostics

The *Configuration and Debug* menu for this gateway is arranged as a tree structure, with the *Main* menu at the top of the tree, and one or more sub-menus for each menu command. The first menu you see when you connect to the gateway is the *Main* menu.

Because this is a text-based menu system, you enter commands by typing the [command letter] from your computer keyboard in the *Diagnostic* window in *ProSoft Configuration Builder (PCB)*. The gateway does not respond to mouse movements or clicks. The command executes as soon as you press the **[COMMAND LETTER]** — you do not need to press **[ENTER]**. When you type a **[COMMAND LETTER]**, a new screen will be displayed in your terminal application.

5.2.1 Required Hardware

You can connect directly from your PC's serial port to the serial port on the gateway to view configuration information, perform maintenance, and send or receive configuration files.

ProSoft Technology recommends the following minimum hardware to connect your PC to the gateway:

- 80486 based processor (Pentium preferred)
- 1 megabyte of memory
- At least one UART hardware-based serial communications port available. USB-based virtual UART systems (USB to serial port adapters) often do not function reliably, especially during binary file transfers, such as when uploading/downloading configuration files or gateway firmware upgrades.

5.2.2 Using the Diagnostic Window in ProSoft Configuration Builder

Tip: You can have a ProSoft Configuration Builder Diagnostics window open for more than one module at a time.

To connect to the gateway's Configuration/Debug serial port

- 1 Start *PCB*, and then select the gateway to test. Click the right mouse button to open a shortcut menu.

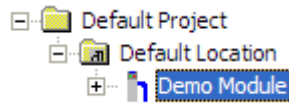

- 2 On the shortcut menu, choose **DIAGNOSTICS**.

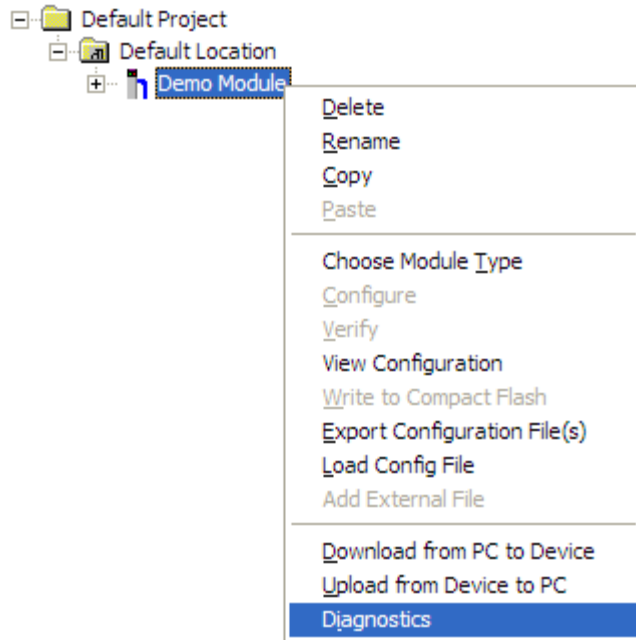

This action opens the *Diagnostics* dialog box.

- 3 Press [?] to open the *Main* menu.

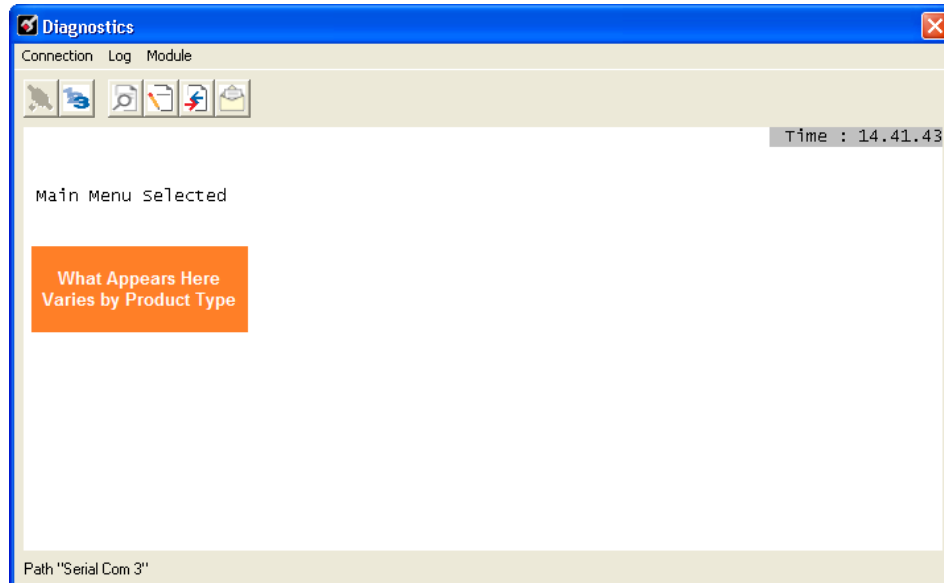

If there is no response from the gateway, follow these steps:

- 1 Click to configure the connection. On the *Connection Setup* dialog box, select a valid com port or other connection type supported by the gateway.

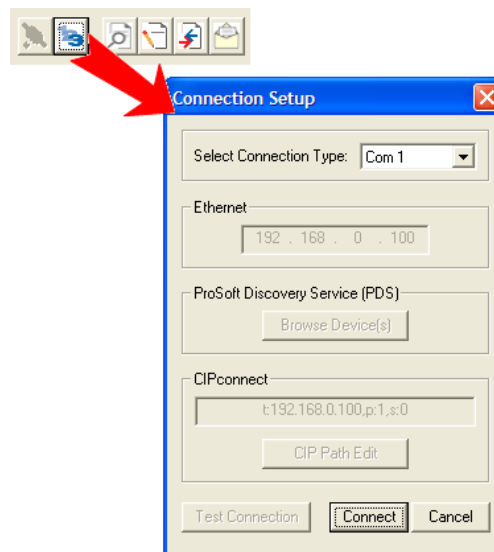

- 2 Verify that the null modem cable is connected properly between your computer's serial port and the gateway. A regular serial cable will not work.
 - 3 On computers with more than one serial port, verify that your communication program is connected to the same port that is connected to the gateway.
- If you are still not able to establish a connection, contact ProSoft Technology for assistance.

5.2.3 Navigation

All of the submenus for this gateway contain commands to redisplay the menu or return to the previous menu. You can always return from a submenu to the next higher menu by pressing **[M]** on your keyboard.

The organization of the menu structure is represented in simplified form in the following illustration:

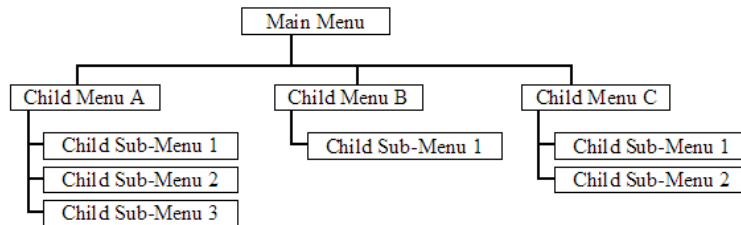

The remainder of this section shows the menus available for this gateway, and briefly discusses the commands available to you.

Keystrokes

The keyboard commands on these menus are usually not case sensitive. You can enter most commands in lowercase or uppercase letters.

The menus use a few special characters (**?**, **-**, **+**, **@**) that must be entered exactly as shown. Some of these characters will require you to use the **SHIFT**, **CTRL**, or **ALT** keys to enter them correctly. For example, on US English keyboards, enter the **?** command as **SHIFT** and **/**.

Also, take care to distinguish the different uses for uppercase letter "eye" (**I**), lowercase letter "el" (**L**), and the number one (**1**). Likewise, uppercase letter "oh" (**O**) and the number zero (**0**) are not interchangeable. Although these characters look alike on the screen, they perform different actions on the gateway and may not be used interchangeably.

Redisplaying the Menu

Press **[?]** to display the current menu. Use this command when you are looking at a screen of data, and want to view the menu choices available to you.

5.2.4 Main Menu

When you first connect to the module from your computer, your terminal screen will be blank. To activate the *Main* menu, press the **[?]** key on your computer's keyboard. If the module is connected properly, the following menu will appear.

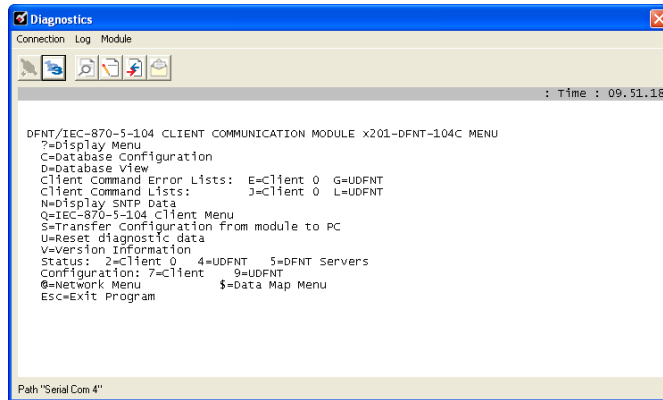
A screenshot of a terminal window titled "Diagnostics". The window has a menu bar with "Connection", "Log", and "Module". Below the menu bar are several icons. The main area of the window displays a list of menu options: "?=Display Menu", "C=Database Configuration", "D=Database View", "Client Command Error Lists: E=Client 0 G=UDFNT", "Client Command Lists: J=Client 0 L=UDFNT", "N=Display SNMP Data", "Q=IEC-870-5-104 Client Menu", "S=Transfer Configuration From module to PC", "U=Reset diagnostic data", "V=Version Information", "Status: 2=Client 0 4=UDFNT 5=DFNT Servers", "Configuration: 7=Client 9=UDFNT", "@=Network Menu", "\$=Data Map Menu", and "Esc=Exit Program". The status bar at the bottom of the window shows "Path: 'Serial Com 4'" and "Time : 09.51.18".

```
Diagnostics
Connection Log Module
: Time : 09.51.18

DFNT/IEC-870-5-104 CLIENT COMMUNICATION MODULE x201-DFNT-104C MENU
?=Display Menu
C=Database Configuration
D=Database View
Client Command Error Lists: E=Client 0 G=UDFNT
Client Command Lists: J=Client 0 L=UDFNT
N=Display SNMP Data
Q=IEC-870-5-104 Client Menu
S=Transfer Configuration From module to PC
U=Reset diagnostic data
V=Version Information
Status: 2=Client 0 4=UDFNT 5=DFNT Servers
Configuration: 7=Client 9=UDFNT
@=Network Menu
$=Data Map Menu
Esc=Exit Program

Path: "Serial Com 4"
```

Caution: Some of the commands available to you from this menu are designed for advanced debugging and system testing only, and can cause the gateway to stop communicating with the processor or with other devices, resulting in potential data loss or other communication failures. Use these commands only if you fully understand their potential effects, or if you are specifically directed to do so by ProSoft Technology Technical Support Engineers. There may be some special command keys that are not listed on the menu but that may activate additional diagnostic or debugging features. If you need these functions, you will be advised how to use them by Technical Support. Please be careful when pressing keys so that you do not accidentally execute an unwanted command.

Database Configuration

Press **[C]** to view the *Module Configuration* screen.

Use this command to display the current configuration and statistics for the gateway.

Opening the Database View Menu

Press **[D]** to open the *Database View* menu.

Use this menu command to view the current contents of the gateway's database. For more information about this submenu, see Database View Menu (page 99).

Viewing SNTP Status

Press **[N]** to view configuration information about the SNTP Client.

```
SNTP CLIENT CONFIGURATION:
NTP SERVER IP : 0.0.0.0
DB REGISTER   : -1
TIME ZONE     : 0           USE DST       : No
TIME VALID    : No
REQUESTS     : 0           RESPONSES  : 0
COMPUTATIONS  : 0           TIME SET CNT : 0
TIMEOUT ERRS : 0
```

For more information on configuring and using this function, see SNTP Client (page 17).

Sending the Configuration File

Press **[S]** to upload (send) a configuration file from the gateway to your PC.

Resetting Diagnostic Data

Press **[U]** to reset the status counters for the Client and/or server(s) in the gateway.

Viewing Version Information

Press **[V]** to view version information for the gateway.

Use this command to view the current version of the software for the gateway, as well as other important values. You may be asked to provide this information when calling for technical support on the product.

Values at the bottom of the display are important in determining gateway operation. The *Program Scan Counter* value is incremented each time a gateway's program cycle is complete.

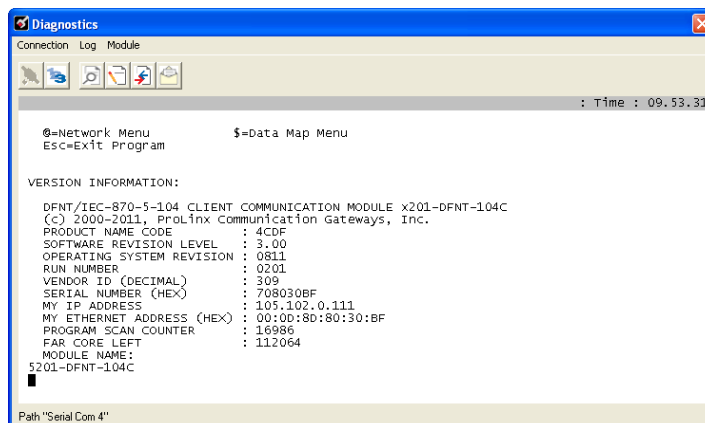

Tip: Repeat this command at one-second intervals to determine the frequency of program execution.

Opening the IEC 870-5-104 Client Menu

Press [**Q**] to view all data associated with the IEC 60870-5-104 Client driver.

Opening the Network Menu

Press [**@**] to open the *Network* menu.

The *Network* menu allows you to send, receive and view the WATTCP.CFG file that contains the IP, gateway and other network specification information. For more information about this submenu, see Network Menu (page 104).

Exiting the Program

Press [**ESC**] to restart the gateway and force all drivers to be loaded. The gateway will use the configuration stored in the gateway's flash memory to configure the gateway.

5.2.5 Database View Menu

Press [**D**] from the *Main* menu to open the *Database View* menu. Use this menu command to view the current contents of the gateway database. Press [**?**] to view a list of commands available on this menu.

```
DB Menu Selected
DATABASE VIEW MENU
?=Display Menu
0-3=Display data page 0-3000
S=Show Again
-=Back 5 Pages
P=Previous Page
+=Skip 5 Pages
N=Next Page
D=Decimal Display
H=Hexadecimal Display
F=Float Display
A=ASCII Display
M=Main Menu
```

Viewing Register Pages

To view sets of register pages, use the keys described below:

Command	Description
[0]	Display registers 0 to 99
[1]	Display registers 1000 to 1099
[2]	Display registers 2000 to 2099

And so on. The total number of register pages available to view depends on your gateway's configuration.

Displaying the Current Page of Registers Again

Press **[S]** from the *Database View* menu to show the current page of registers again.

DATABASE DISPLAY 0 TO 99 <DECIMAL>										
100	101	102	4	5	6	7	8	9	10	
11	12	13	14	15	16	0	0	0	0	0
0	0	0	0	0	0	0	0	0	0	0
0	0	0	0	0	0	0	0	0	0	0
0	0	0	0	0	0	0	0	0	0	0
0	0	0	0	0	0	0	0	0	0	0
0	0	0	0	0	0	0	0	0	0	0
0	0	0	0	0	0	0	0	0	0	0
0	0	0	0	0	0	0	0	0	0	0
0	0	0	0	0	0	0	0	0	0	0

This screen displays the current page of 100 registers in the database.

Moving Back Through 5 Pages of Registers

Press **[-]** from the *Database View* menu to skip five pages back in the database to see the 100 registers of data starting 500 registers before the currently displayed page.

Moving Forward (Skipping) Through 5 Pages of Registers

Press **[+]** from the *Database View* menu to skip five pages ahead in the database to see the 100 registers of data starting 500 registers after the currently displayed page.

Viewing the Previous Page of Registers

Press **[P]** from the *Database View* menu to display the previous page of data.

Viewing the Next Page of Registers

Press **[N]** from the *Database View* menu to display the next page of data.

Viewing Data in Decimal Format

Press **[D]** from the *Database View* menu to display the data on the current page in decimal format.

Viewing Data in Hexadecimal Format

Press **[H]** from the *Database View* menu to display the data on the current page in hexadecimal format.

Viewing Data in Floating-Point Format

Press **[F]** from the *Database View* menu to display the data on the current page in floating-point format. The program assumes that the values are aligned on even register boundaries. If floating-point values are not aligned as such, they are not displayed properly.

Viewing Data in ASCII (Text) Format

Press **[A]** from the *Database View* menu to display the data on the current page in ASCII format. This is useful for regions of the database that contain ASCII data.

Returning to the Main Menu

Press **[M]** to return to the *Main* menu.

5.2.6 IEC-870-5-104 Client Menu

Press **[Q]** from the main menu to open the IEC-870-5-104 Client Menu.

```
IEC-104 Client Menu selected
IEC-870-5-104 CLIENT DRIVER MENU
?=Display Menu
C=General Configuration
I=Command List Menu
P=Client Configuration Menu
Q=Client Status Menu
S=Session Menu
V=Version
M=Previous Menu
```

Viewing Command Lists

Press **[I]** to view the Command List Menu.

```
Command List Menu Selected

IEC-870-5-104 COMMAND LIST MENU
?=Display Menu
S=Show Again
-=Back 5 Pages
P=Previous Page
+=Skip 5 Pages
N=Next Page
M=Main Menu
```

IEC-870-5-104 Configuration Menu

From the *IEC-870-5-104 Client* menu, press **[P]** to open the *IEC-870-5-104 Configuration* menu. This menu shows the gateway parameters in the configuration file.

```
MODULE CONFIGURATION
Time DB Offset = 2000
Status Offset = 2010
Mailbox Offset = 3000
Online States = 0x00000000 (bit mapped in hex format)
Command Count = 10 (of maximum 500)
Current Command = 0
Current Busy = 0
Command Queue = 0
App Rec Mem Cnt = 0
App Trn Mem Cnt = 0
App Any Mem Cnt = 0
Pass-Through Events = YES
Event Msg Count = 0
Event Msg Overflow = NO
```

IEC-870-5-104 Status Data

From the *IEC-870-5-104 Client* menu press **[Q]** to display the *IEC-870-5-104 Status Data* screen.

```
IEC-870-5-104 CLIENT 0 STATUS
Send Seq= 0          Rec Seq #= 0          Last Ack #= 0          Rec UnAcked= 0
In Queue= 0         First Id = 0          Current Id= 0
TX Count= 0         RX Count = 0
ERRS: t0= 0         t1 tmouts= 0          t2 tmouts = 0          t3 timeouts= 0
   Seq #= 0         Bad Adrss= 0         Bad length= 0
SOCKET DATA:      Act State= 0          State = 2000
  Opens = 124      Close Cnt= 0         Conn Cnt = 0
  Host IP= 192.168.9.20
  Pending Session # = 65535  Tx state = Idle
COMMAND DATA:
  Commands Executed = 0      Command Responses = 0
  Command Err Count = 123   Request Count = 0
  Response Count = 0        Error Sent Count = 0
  Error Rec Count = 0       Cfg Error word = 0x0000
  Current Error Code = 0x0387 Last Error Code = 0x0387
```

For more information about these values, please refer to the 104C Module Status Data Definition section.

Viewing Command Lists

Press **[S]** to view the Sessions Menu.

```
IEC-870-5-104 SESSION 0 CONFIGURATION
Online State = 1
Sector Count = 1
Common ASDU Length = 2
IOA Length = 3
COT Octet Count = 2
COT Originator Address = 0
Response Timeout = 2000
ACTTERM with setpoint = 1█
```

5.2.7 Network Menu

From the *IEC-870-5-104 Client Main* menu press [**@**] to display the *IEC-870-5-104 Network* menu screen. The *Network* menu allows you to send, receive, and view the WATTCP.CFG file that contains the IP and gateway addresses, and other network information.

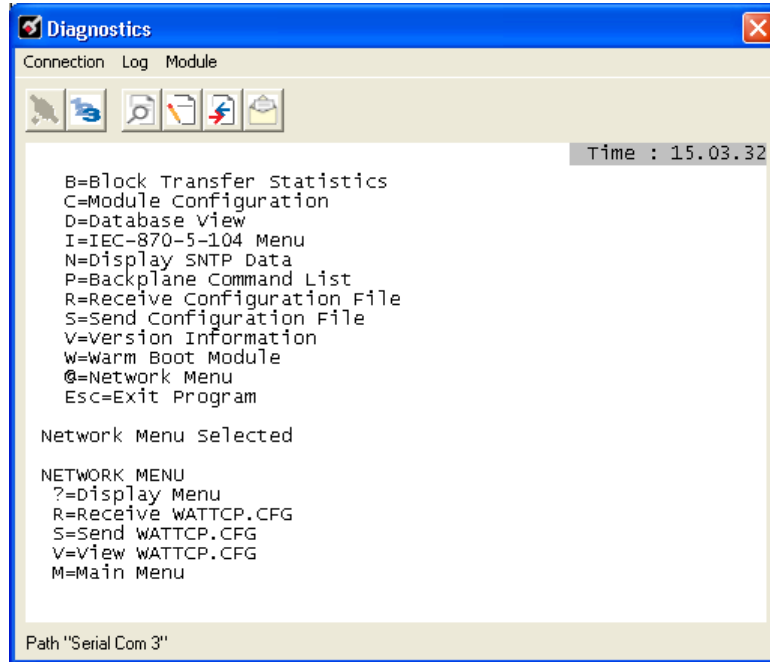

Viewing the WATTCP.CFG File on the gateway

Press [**V**] to view the gateway's WATTCP.CFG file. Use this command to confirm the gateway's current network settings.

```
WATTCP.CFG FILE:
# ProLinX Communication Gateways, Inc.
# Default private class 3 address
my_ip=192.168.0.75
# Default class 3 network mask
netmask=255.255.255.0
# name server 1 up to 9 may be included
# nameserver=xxx.xxx.xxx.xxx
# name server 2
# nameserver=xxx.xxx.xxx.xxx
# The gateway I wish to use
gateway=192.168.0.1
# some networks (class 2) require all three parameters
# gateway,network,subnetmask
# gateway 192.168.0.1,192.168.0.0,255.255.255.0
# The name of my network
# domainlist="mynetwork.name"
```

Returning to the Main Menu

Press [**M**] to return to the *Main* menu.

6 Reference

In This Chapter

- ❖ Product Specifications 106
- ❖ SNTP Support 110
- ❖ Server Error and Status Data 111
- ❖ IEC 60870-5-104 Client Interoperability Statement 117

6.1 Product Specifications

6.1.1 General Specifications

ProLinx® Communication Gateways provide connectivity for two or more dissimilar network types. The gateways, encased in sturdy extruded aluminum, are stand-alone, DIN-rail-mounted solutions that provide data transfer between many of today's most widely used industrial automation protocols.

6.1.2 Internal Database

The ProLinx gateway contains an internal database that consists of areas for application data, status information, and configuration information.

The internal database is shared between all ports on the gateway and is used as a conduit to pass information from a device on one network to one or more devices on another network.

Application Data Area

The protocol drivers exchange data by storing and retrieving data from a shared application memory data area. The database is used as a source for data to be sent to remote devices and holds data received from the remote devices. For protocol drivers that act as Masters or Clients, commands defined in the configuration file (stored in the configuration data area) control how the data is to be handled in the database. For protocol drivers that act as slaves or servers, the remote Master or Client must be properly programmed to send data to or request data from the correct memory addresses in the gateway application data area.

Status Data Area

This area stores error codes, counters, and other status information.

Optional Web Server for Ethernet Solutions

An HTML server is available for Ethernet ProLinx gateways. With this option, HTML pages can be created to:

- Display gateway internal register and status values
- Accept user data input values via POST commands for setpoint, on/off control, and so on.
- Provide limited graphic file support

Type	Specifications
HTML Server (See note below)	Key features of the HTML server include: Max HTML page size: 1MB Max File Storage: 32MB Supported context types: jpeg, bmp, css Supported data types: bit, ASCII, integer, float Sockets: Up to five connections. Note that this limits the number of simultaneous graphic file and frame references per HTML page
FTP Server	Permits remote HTML file transfer between the gateway and remote host. Capabilities of the FTP Server include: Single socket connection Non-passive transfers only WS_FTP or Command Line FTP recommended CuteFTP, Internet Explorer, Netscape, or NCFTP all support multiple socket connections and therefore are not supported by the ProLinx gateway

Important Note: The Web Server is not designed to act like, or replace, the powerful web servers available in the marketplace today. Please check application specifics with Technical Support if you are unsure if your application will work with the ProLinx Web Server.

6.1.3 Hardware Specifications

Specification	Description
Power Supply	24 Vdc nominal 18 Vdc to 32 Vdc allowed Positive, Negative, GND Terminals 2.5 mm screwdriver blade
Current Load	500 mA maximum @ 32 Vdc maximum
Operating Temperature	-4°F to 122°F (-20°C to 50°C)
Storage Temperature	-40°F to 185°F (-40°C to 85°C)
Relative Humidity	5% to 95% RH with no condensation
Dimensions (Height x Width x Depth)	Standard: 5.20 in x 2.07 in x 4.52 in (13.2 cm x 5.25 cm x 11.48 cm) Extended: 5.20 in x 2.73 in x 4.52 in (13.2 cm x 6.934 cm x 11.48 cm)
LED Indicators (On all gateways)	Power and Hardware Fault Configuration and Application Communication Status Serial Configuration Port Activity and Error
Configuration Serial Port	DB-9M RS-232 only No hardware handshaking
Ethernet Port (Ethernet protocol gateways only)	10 Base-T half-duplex RJ45 Connector Link LED and Activity LED indicators Electrical Isolation 1500 Vrms at 50 Hz to 60 Hz for 60 seconds, applied as specified in section 5.3.2 of IEC 60950: 1991 Ethernet Broadcast Storm Resiliency = less than or equal to 5000 [ARP] frames-per-second and less than or equal to 5 minutes duration
Application Serial Port(s) (Serial protocol gateways only)	RS-232/422/485 RS-232 handshaking configurable RS-422/485 DB-9 to Screw Terminal Adapter Note: The number of serial application ports depends on the gateway type, and the combination of protocols.
Serial Port Isolation	2500 Vrms port signal isolation per UL 1577 3000 Vdc min. isolation port to ground and port to logic
Shipped with Each Unit	Mini-DIN to DB-9M serial cables 4-foot RS-232 configuration cable 2.5 mm screwdriver CD (docs and configuration utility) RS-422/485 DB-9 to Screw Terminal Adapter for each serial application port (serial protocols only)

6.1.4 Port Physical and Protocol Specifications

104 Server Specifications

The gateway acts as a link between the IEC-870-5-104, other protocols and networks, as well as several proprietary interfaces. A 4000-word register space in the gateway exchanges data between the two protocols.

General specifications include:

- Supports storage and transfer of up to 4000 registers between protocols
- User-definable gateway memory usage
- IEC time used by the gateway can be stored in the memory database
- Configures via a user-generated text file download to the gateway
- Protocol implementation conforms to the IEC-870-5-104 specification with fully configurable parameters

Driver Protocol Specifications

General Parameters

Internal Database	4000 registers (words) available
Communication parameters	10Base-T half duplex RJ45 Connector Link and Activity LED indicators
Status Data	Status data is returned in a block of counter values allowing communications to be effectively debugged.
Conformance Specifications	See IEC 60870-5-104 Server Interoperability Document

Server Functional Specifications

The 104C gateway sends commands to one or more remote server units on the Ethernet network. It also accepts monitor data sent by remote servers. Data transferred to the server comes from the gateway's internal database. Remote server devices use the IEC-870-5-104 protocol to receive control outputs and send monitor inputs using the fully-configurable gateway application database. The remote server devices can overwrite data in the database and, thereby, pass control data to devices connected to the gateway using standard control messages supported by the other gateway protocol.

6.2 SNTP Support

SNTP is used for time synchronization of produced and consumed commands. When an exchange occurs the driver compares time stamps from the previous exchange. When the new exchange time is less than the previous exchange, the exchange is ignored. This can occur when the Ethernet packets are routed and delayed. Time synchronization provides for data integrity. The following table lists the parameters defined in this section:

The SNTP driver will compute a new clock value every 5 minutes using the average value of 10 samples each collected over an approximate 6-second period. This new value will be used to adjust the clock maintained by the SNTP driver and used by the application. If a valid database register is specified, the driver will place the time value into the gateway's database. The first two registers will contain the number of seconds and the next two registers will contain the number of microseconds since January 1, 1970.

A list of some of the common NTP servers can be obtained at <http://www.ntp.org/>, <http://www.eecis.udel.edu/~mills/ntp/servers.html>, along with the appropriate IP address. Other server lists can be found on the Internet by searching on "NTP Servers" with your browser.

6.2.1 SNTP Status Data

The status data for the SNTP driver is located at the virtual database addresses shown in the following table. The data area is initialized with zeros whenever the gateway is initialized. This occurs during a cold-start (power-on), reset (reset push-button pressed) or warm-boot operation (commanded or loading of new configuration).

SNTP Client Status	
4030	Time is valid
4031	Request count
4032	Response count
4033	Computation count
4034	Clock set count
4035	Timeout error count

The gateway's data mapping feature can be utilized to move this data into the gateway's database area. This way the data can be made available to all drivers on the gateway for use on any of the connected networks. If it is not mapped into the gateway's database, the data will only be available through the Configuration/Debug Port.

The *Time is Valid* status register will be set to 1 if the SNTP time is valid. If the time is not valid, the register will be set to 0. All the other registers are counters used to determine the functionality of the driver.

This version of the driver supports SNTP Revision 3 and stratum between 1 and 14.

6.3 Server Error and Status Data

The Driver Error and Status Data areas represent a collection of status, diagnostic and troubleshooting registers which may prove helpful in troubleshooting the 104C network and port operation. The data map functionality of the gateway must be utilized to map this data into the application gateway database area (memory word addresses 0 to 3999). All or any portion of the data can be moved using the Data Map.

The data area is initialized with zeros whenever the gateway is initialized. This occurs during a cold-start (power-on), reset (reset push-button pressed) or a warm-boot operation (commanded or loading of new configuration).

The command errors can be copied from the virtual database area into the 4000-word database using the map feature with the following data source:

Status Register	Description
COMMAND ERRORS	
22000 to 22499	Each register contains the last error code for a command. This data area holds the error code list for the 500 potential commands for the driver.

Source Data	Description
22000	Command #1 Error Code
22001	Command #2 Error Code
...	...
22499	Command #500 Error Code

The following error codes are valid to the module:

IEC870-5-104 CLIENT DRIVER ERROR CODES

ERROR	DESCRIPTION
0	No Error
201	Application layer error - Length mismatch
202	Application layer error - Address unknown
203	Application layer error - Response late
251	RBE error - Clock event buffer overflow
252	RBE error - Event buffer overflow
271	Data error - Address unknown
281	Control error - Illegal operation
282	Control error - Illegal value
283	Control error - Not selected
301	Initialization error - Database

302	Initialization error - Out of memory
401	Channel open error
501	Session error - Database
502	Session error - Configuration
601	No memory to receive message
602	Session not reserved
603	Illegal session
604	Session is reserved
605	Session is not available
701	No memory to transmit message
702	ASDU not supported
703	Duplicate request
704	Illegal sector
705	Control mode is illegal
801	Partial stop request
802	Stop request failed
901	Response timeout
902	Negative COT in response
903	Session is offline
904	Session is disabled
905	Select confirmation received, waiting to execute
906	Execute confirmation has not be received
0xffd0 (-48)	Error ARP'ing server
0xffd1 (-47)	ARP timeout to server
0xffdb (-37)	Connection timeout (t0) when establishing connection to server
0xffdf (-33)	SYN not accepted by server

You can use the following parameter to map the general driver status data to the module database:

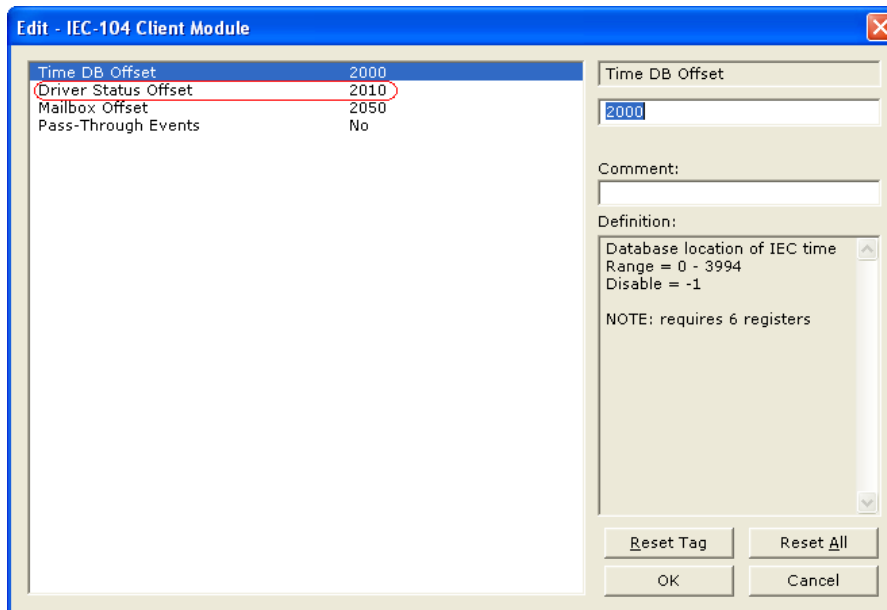

GENERAL DRIVER STATUS

OFFSET	PARAMETER	DESCRIPTION
0	Event Msg Cnt	This word contains the number of event messages waiting to send from the driver.
1	Event Msg Overflow	This word contains a value of 0 if the event message buffer has not overflowed. If the event buffer overflows, this word will be set to a value of 1.
2	Session Count	This word contains the number of sessions supported by the driver (4).
3	Current Cmd	This word contains the index of the current command being executed in the command list.
4	Cmd Busy Flag	This word is set to zero if no command is currently being executed and waiting on a response. If the word is set to 1, a command is currently executing.
5	Cmd Count	This word contains the count of the number of commands configured for the driver.
6	Cmd Delay	This word contains the command delay counter preset. There is a fixed delay between each command to permit the module to perform other operations.
7	Cmd Queue	This word is set to zero if the command executing is from the command list. If the executing command is from the command queue, the word will be set to 1.

8	Cmd Queue Count	This word contains the number of active commands in the command queue for the driver. Up to 100 commands can be buffered in this queue. These commands are transferred to the driver from the mailbox interface.
9 to 10	Online Status	This double word value contains a bit for each of the 4 potential sessions in the module. If the bit is set for a session in the double word, the station is online. If the bit is clear, the station is offline. Use this value to determine if commands sent to the driver will have a chance of succeeding.
11	Spare	Reserved
12	SNTP Valid	NTP time is valid (0=No, 1=Yes)
13	NTP Request	Number of requests to NTP server
14	NTP Response	Number of responses from NTP server
15	SNTP Computation	Number of times SNTP time computed
16	SNTP Set	Number of times SNTP time set
17	NTP Timeout	Number of NTP response timeouts

You can also copy the client status data to the module database through the following parameter:

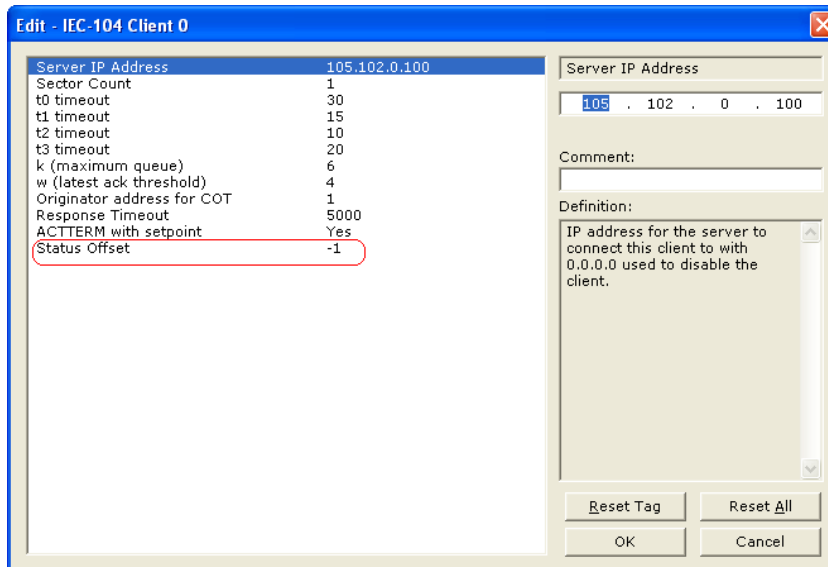

Follows below the contents of the status offset data block:

OFFSET	PARAMETER	DESCRIPTION
0	Active	Active status of client 0 = not active 1 = waiting on StartDT con 2 = Online (StartDT con received)
1	State	State of Client Socket: -255 = Idle until processor in run -1 = Ready for socket open 0 = Waiting for socket establish 1 = Read and write data to socket (process data) 70 = Sending StartDT act 80 = Sending StopDT act 100 = End program/close socket 1000 = Close socket (start 2-second timeout) 1001 = Wait for close & abort if timeout 2000 = ARP request/response 2001 = Open Socket
2	Open Count	Number of times socket open attempted
3	Close Count	Number of times socket closed
4	Connect Count	Number of times socket established
5-14	Host IP	ASCII string of remote server IP address (10 words)
15	t0 Timeouts	Number of t0 timeouts
16	t1 Timeouts	Number of t1 timeouts
17	t2 Timeouts	Number of t2 timeouts
18	t3 Timeouts	Number of t3 timeouts
19	Sequence Errors	Number of sequence errors
20	Bad Address Errors	Number of bad address errors
21	Length Errors	Number of length errors
22	Rx Frame Count	Number of frames received on socket
23	Tx Frame Count	Number of frames transmitted on socket
24	Cmd Requests	Number of commands issued from command list and queue
25	Cmd Responses	Number of responses to commands issued from command list and queue.
26	Cmd Error Count	Number of errors recognized when issued from command list or queue
27	Requests	Number of requests from command driver
28	Responses	Number of messages received by command driver
29	Errors Sent	Number of errors sent by command driver (not used)
30	Errors Received	Number of errors received by command driver
31	Configuration Error	Configuration error word for client
32	Current Error	Current error recognized
33	Last Error	Last error recognized
34	Send Number	Send sequence number

35	Rec Number	Received sequence number
36	Ack Number	Last acknowledged sequence number
37	Queue Max	Maximum number of queue (k)
38	Queue Threshold	Queue threshold before S-Frame sent (w)
39	Rec Packets	Number of I-frames received but not acknowledged
40	Queue Now	Number of messages in queue
41	Queue First	First index of message in queue
42	Queue Index	Current index of message in queue
43	Spare	Reserved for future use

6.4 IEC 60870-5-104 Client Interoperability Statement

This companion standard presents sets of parameters and alternatives from which subsets have to be selected to implement particular telecontrol systems. Certain parameter values, such as the number of octets in the COMMON ADDRESS of ASDUs represent mutually exclusive alternatives. This means that only one value of the defined parameters is admitted per system. Other parameters, such as the listed set of different process information in command and in monitor direction allow the specification of the complete set or subsets, as appropriate for given applications. This clause summarizes the parameters of the previous clauses to facilitate a suitable selection for a specific application. If a system is composed of equipment stemming from different manufacturers it is necessary that all partners agree on the selected parameters.

Note: In addition, the full specification of a system may require individual selection of certain parameters for certain parts of the system, such as the individual selection of scaling factors for individually addressable measured values.

The selected parameters should be marked in the white boxes as follows:

- Function or ASDU is not used
- Function or ASDU is used as standardized (default)
- R Function or ASDU is used in reverse mode
- B Function or ASDU is used in standard and reverse mode

The possible selection (blank, X, R, B) is specified for each specific clause or parameter.

A black check box indicates that the option cannot be selected in this companion standard.

6.4.1 System or device

- System definition
- Controlling station definition (Master)
- Controlled station definition (Slave)

6.4.2 Application Layer

Transmission mode for application data

Mode 1 (Least significant octet first), as defined in clause 4.10 of IEC 60870-5-4, is used exclusively in this companion standard.

Common Address of ASDU

(System-specific parameter)

One octet Two octets

Information object address

(System-specific parameter)

One octet Structured
 Two octets Unstructured
 Three octets

Cause of transmission

(System-specific parameter)

One octet Two octets (with originator address)

Length of APDU

(System-specific parameter, specify the maximum length of the APDU per system)

The Maximum length of the APDU is 253 (default). The maximum length may be reduced by the system.

253 Maximum length of APDU per system

6.4.3 Selection of standard ASDUs

Process information in monitor direction

(Station-specific parameter, mark each Type ID 'X' if it is only used in the standard direction, "R" if only used in the reverse direction, and "B" if used in both directions)

- | | | | |
|-------------------------------------|------|---|-----------|
| <input checked="" type="checkbox"/> | <1> | := Single-point information | M_SP_NA_1 |
| <input checked="" type="checkbox"/> | <3> | := Double-point information | M_DP_NA_1 |
| <input checked="" type="checkbox"/> | <5> | := Step position information | M_ST_NA_1 |
| <input checked="" type="checkbox"/> | <7> | := Bitstring of 32 bit | M_BO_NA_1 |
| <input checked="" type="checkbox"/> | <9> | := Measured value, normalized value | M_ME_NA_1 |
| <input checked="" type="checkbox"/> | <11> | := Measured value, scaled value | M_ME_NB_1 |
| <input checked="" type="checkbox"/> | <13> | := Measured value, short floating point value | M_ME_NC_I |
| <input checked="" type="checkbox"/> | <15> | := Integrated totals | M_IT_NA_1 |
| <input type="checkbox"/> | <20> | := Packed single-point information with status change detection | M_PS_NA_1 |
| <input type="checkbox"/> | <21> | := Measured value, normalized value without quality descriptor | M_ME_ND_1 |
| <input checked="" type="checkbox"/> | <30> | := Single-point information with time tag CP56Time2a | M_SP_TB_1 |
| <input checked="" type="checkbox"/> | <31> | := Double-point information with time tag CP56Time2A | M_DP_TB_1 |
| <input checked="" type="checkbox"/> | <32> | := Step position information with time tag CP56Time2A | M_ST_TB_1 |
| <input checked="" type="checkbox"/> | <33> | := Bitstring of 32 bit with time tag CP56Time2A | M_BO_TB_1 |
| <input checked="" type="checkbox"/> | <34> | := Measured value, normalized value with time tag CP56Time2A | M_ME_TD_1 |
| <input checked="" type="checkbox"/> | <35> | := Measured value, scaled value with time tag CP56Time2A | M_ME_TE_1 |
| <input checked="" type="checkbox"/> | <36> | := Measured value, short floating point value with time tag CP56Time2A | M_ME_TF_1 |
| <input checked="" type="checkbox"/> | <37> | := Integrated totals with time tag CP56Time2A | M_IT_TB_1 |
| <input type="checkbox"/> | <38> | := Event of protection equipment with time tag CP56Time2A | M_EP_TD_1 |
| <input type="checkbox"/> | <39> | := Packed start events of protection equipment with time tag CP56time2A | M_EP_TE_1 |
| <input type="checkbox"/> | <40> | := Packed output circuit information of protection equipment with time tag CP56Time2a | M_EP_TF_1 |

Process information in control direction

(Station-specific parameter, mark each Type ID 'X' if it is only used in the standard direction, "R" if only used in the reverse direction, and "B" if used in both directions)

- ☒ <45> := Single command C_SC_NA_1
- ☒ <46> := Double command C_DC_NA_1
- ☒ <47> := Regulating step command C_RC_NA_1
- ☒ <48> := Set point command, normalized value C_SE_NA_1
- ☒ <49> := Set point command, scaled value C_SE_NB_1
- ☒ <50> := Set point command, short floating point value C_SE_NC_1
- ☒ <51> := Bitstring of 32 bit C_BO_NA_1
- ☒ <58> := Single command with time tag CP56Time2a C_SC_TA_1
- ☒ <59> := Double command with time tag CP56Time2A C_DC_TA_1
- ☒ <60> := Regulating step command with time tag CP56Time2A
C_RC_TA_1
- ☒ <61> := Set point command, normalized value with time tag
CP56Time2A C_SE_TA_1
- ☒ <62> := Set point command, scaled value with time tag CP56Time2A
C_SE_TB_1
- ☒ <63> := Set point command, short float value with time tag
CP56Time2A C_SE_TC_1
- ☒ <64> := Bitstring of 32 bit with time tag CP56Time2A C_BO_TA_1

Either the ASDUs of the set <45>-<51> or of the set <58>-<64> are used.

System information in monitor direction

(Station-specific parameter, mark "X" if used)

- ☒ <70> := End of initialization M_EI_NA_1

System information in control direction

(Station-specific parameter, mark each Type ID 'X' if it is only used in the standard direction, "R" if only used in the reverse direction, and "B" if used in both directions)

- ☒ <100> := Interrogation command C_IC_NA_1
- ☒ <101> := Counter interrogation command C_CI_NA_1
- ☒ <102> := Read command C_RD_NA_1
- ☒ <103> := Clock synchronization command C_CS_NA_1
- ☒ <105> := Reset process command C_RP_NC_1
- ☒ <107> := Test command with time tag CP56Time2a C_TS_TA_1

Parameter in control direction

(Station-specific parameter, mark each Type ID 'X' if it is only used in the standard direction, 'R' if only used in the reverse direction, and 'B' if used in both directions)

- <110> := Parameter of measured value, normalized value P_ME_NA_1
- <111> := Parameter of measured value, scaled value P_ME_NB_1
- <112> := Parameter of measured value, short floating point value P_ME_NC_1
- <113> := Parameter activation P_AC_NA_1

File transfer

(Station-specific parameter, mark "X" if function is used)

File transfer in monitor direction

- Transparent file
- Transmission of disturbance data of protection equipment
- Transmission of sequence of events
- Transmission of sequence of recorded analogue values

File transfer in control direction

- Transparent file

6.4.4 Type identifier and cause of transmission assignments

(Station-specific parameters)

Shaded boxes: option not required

Black boxes: option not permitted in this companion standard

Blank boxes: functions or ASDU not used

Mark Type Identification/Cause of Transmission combinations: 'X' if only used in standard direction, 'R' if only used in reverse direction, and 'B' if used in both directions

Type Identification	Cause of transmission																
	1	2	3	4	5	6	7	8	9	10	11	12	13	20 to 26	37 to 38	44 to 45	46 to 47
<1> M EP NA 1		X	X	X								X	X	X			
<2> M OP NA 1		X	X	X								X	X	X			
<3> M ST NA 1		X	X	X								X	X	X			
<4> M BO NA 1		X	X	X										X			
<5> M ME NA 1		X	X	X	X									X			
<11> M ME NB 1		X	X	X	X									X			
<13> M ME NC 1		X	X	X	X									X			
<15> M IT NA 1		X													X		
<20> M PS NA 1																	
<21> M ME NG 1																	
<30> M SP TB 1		X	X									X	X				
<31> M OP TB 1		X	X									X	X				
<32> M ST TB 1		X	X									X	X				
<33> M BO TB 1		X	X														
<34> M ME TD 1		X	X														
<35> M ME TE 1		X	X														
<36> M ME TF 1		X	X														
<37> M IT TB 1		X													X		
<38> M EP TB 1																	
<39> M EP TE 1																	
<40> M EP TF 1																	
<45> C SC NA 1				X	X	X	X	X						X	X	X	X
<46> C DC NA 1				X	X	X	X	X						X	X	X	X
<47> C RC NA 1				X	X	X	X	X						X	X	X	X
<48> C BE NA 1				X	X	X	X	X						X	X	X	X
<49> C BE NB 1				X	X	X	X	X						X	X	X	X
<50> C BE NC 1				X	X	X	X	X						X	X	X	X
<51> C BO NA 1				X	X									X	X	X	X
<56> C DC TA 1				X	X	X	X	X						X	X	X	X
<58> C DC TA 1				X	X	X	X	X						X	X	X	X
<60> C RC TA 1				X	X	X	X	X						X	X	X	X
<61> C BE TA 1				X	X	X	X	X						X	X	X	X
<62> C BE TB 1				X	X	X	X	X						X	X	X	X
<63> C BE TC 1				X	X	X	X	X						X	X	X	X
<64> C BO TA 1				X	X			X						X	X	X	X
<70> M EI NA 1			X														
<100> C AC NA 1				X	X	X	X	X						X	X	X	X
<101> C CI NA 1				X	X			X						X	X	X	X
<102> C RD NA 1				X										X	X	X	X
<103> C CS NA 1				X	X									X	X	X	X
<106> C RP NA 1				X	X									X	X	X	X
<107> C TS TA 1				X	X									X	X	X	X
<110> P ME NA 1				X	X									X	X	X	X
<111> P ME NB 1				X	X									X	X	X	X
<112> P ME NC 1				X	X									X	X	X	X
<113> P AC NA 1				X	X	X	X							X	X	X	X
<120> F FR NA 1																	
<121> F BR NA 1																	
<122> F SC NA 1																	
<123> F LS NA 1																	
<1124> F AF NA 1																	
<125> F SG NA 1																	
<126> F DR TA 1																	
<127> F SC NB 1																	

6.4.5 Basic Application Functions

Station initialization

(Station-specific parameter, mark "X" if function is used)

- Remote initialization

Cyclic data transmission

(Station-specific parameter, mark "X" if function is only used in the standard direction, "R" if only used in the reverse direction, and "B" if used in both directions)

- Cyclic data transmission

Read procedure

(Station-specific parameter, mark "X" if function is only used in the standard direction, "R" if only used in the reverse direction, and "B" if used in both directions)

Read procedure

Spontaneous transmission

(Station-specific parameter, mark "X" if function is only used in the standard direction, "R" if only used in the reverse direction, and "B" if used in both directions)

Spontaneous transmission

Double transmission of information objects with cause of transmission spontaneous

(Station-specific parameter, mark each information type "X" where both a Type ID without time and corresponding Type ID with time are issued in response to a single spontaneous change of a monitored object)

The following type identifications may be transmitted in succession caused by a single status change of an information object. The particular information object addresses for which double transmission is enabled are defined in a project-specific list.

Single-point information M_SP_NA_1, M_SP_TA_1, M_SP_TB_1 and M_PS_NA_1

Double-point information M_DP_NA_1, MDP_TA_1 and M_DP_TB_1

Step position information M_ST_NA_1, M_ST_TA_1 and M_ST_TB_1

Bitstring of 32 bit M_BO_NA_1, M_BO_TA_1 and M_BO_TB_1

Measured value, normalized value M_ME_NA_1, M_ME_TA_1, M_ME_ND_1 and M_ME_TD_1

Measured value, scaled value M_ME_NB_1, M_ME_TB_1 and M_ME_TE_1

Measured value, short floating point number M_ME_NC_1, M_ME_TC_1 and M_ME_TF_1

Station Interrogation

(Station-specific parameter, mark "**X**" if function is only used in the standard direction, "**R**" if only used in the reverse direction, and "**B**" if used in both directions)

- | | | |
|---|--|--|
| <input checked="" type="checkbox"/> global | | |
| <input checked="" type="checkbox"/> group 1 | <input checked="" type="checkbox"/> group 7 | <input checked="" type="checkbox"/> group 13 |
| <input checked="" type="checkbox"/> group 2 | <input checked="" type="checkbox"/> group 8 | <input checked="" type="checkbox"/> group 14 |
| <input checked="" type="checkbox"/> group 3 | <input checked="" type="checkbox"/> group 9 | <input checked="" type="checkbox"/> group 15 |
| <input checked="" type="checkbox"/> group 4 | <input checked="" type="checkbox"/> group 10 | <input checked="" type="checkbox"/> group 16 |
| <input checked="" type="checkbox"/> group 5 | <input checked="" type="checkbox"/> group 11 | |
| <input checked="" type="checkbox"/> group 6 | <input checked="" type="checkbox"/> group 12 | |

Addresses per group have to be defined

Clock synchronization

(Station-specific parameter, mark "**X**" if function is only used in the standard direction, "**R**" if only used in the reverse direction, and "**B**" if used in both directions)

- Clock synchronization
- Day of week used
- RES1, GEN (time tag substituted/not substituted) used
- SU-bit (summertime) used

Optional, see 7.6 of specification

Command transmission

(Object-specific parameter, mark "X" if function is only used in the standard direction, "R" if only used in the reverse direction, and "B" if used in both directions)

- Direct command transmission
- Direct set point command transmission
- Select and execute command
- Select and execute set point command
- C_SE_ACTTERM used ^{note 2}

- No additional definition
- Short pulse duration (duration determined by a system parameter in the outstation)
- Long pulse duration (duration determined by a system parameter in the outstation)
- Persistent output

- Supervision of maximum delay in command direction of commands and set point commands

Maximum allowable delay of commands and set point commands

Transmission of Integrated totals

(Station- or object-specific parameter, mark "X" if function is only used in the standard direction, "R" if only used in the reverse direction, and "B" if used in both directions)

- Mode A: Local freeze with spontaneous transmission
- Mode B: Local freeze with counter interrogation
- Mode C: Freeze and transmit by counter-interrogation commands
- Mode D: Freeze by counter-interrogation command, frozen values reported spontaneously

- Counter read
- Counter freeze without reset
- Counter freeze with reset
- Counter reset

- General request counter
- Request counter group 1
- Request counter group 2
- Request counter group 3
- Request counter group 4

Parameter loading

(Object-specific parameter, mark "X" if function is only used in the standard direction, "R" if only used in the reverse direction, and "B" if used in both directions)

- Threshold value
- Smoothing factor
- Low limit for transmission of measured value
- High limit for transmission of measured value

Parameter activation

(Object-specific parameter, mark "X" if function is only used in the standard direction, "R" if only used in the reverse direction, and "B" if used in both directions)

- Act/deact of persistent cyclic or periodic transmission of the addressed object

Test procedure

(Station-specific parameter, mark "X" if function is only used in the standard direction, "R" if only used in the reverse direction, and "B" if used in both directions)

B

Test procedure

File transfer

(Station-specific parameter, mark "X" if function is used)

File transfer in monitor direction

- Transparent file
- Transmission of disturbance data of protection equipment
- Transmission of sequence of events
- Transmission of sequence of recorded analogue values

File transfer in control direction

- Transparent file

Background scan

(Station-specific parameter, mark "X" if function is only used in the standard direction, "R" if only used in the reverse direction, and "B" if used in both directions)

- Background scan

Definition of time outs

Parameter	Default Value	Remarks	Selected Value
t ₀	30 seconds	Time-out of connection establishment	1 to 1000
t ₁	15 seconds	Time-out of send or test APDUs	1 to 255
t ₂	10 seconds	Time-out for acknowledges in case of no data messages (t ₂ < t ₁)	1 to 255
t ₃	20 seconds	Time-out for sending test frames in case of a long idle time	1 to 300

Maximum range of values for configurable time-outs: accuracy 1 second.

Maximum number of outstanding I format APDUs k and latest acknowledge APDUs (w)

Parameter	Default Value	Remarks	Selected Value
k	6 APDUs	Maximum difference receive sequence number to send state variable (Maximum value is 12)	1 to 12
w	4 APDUs	Latest acknowledge after receiving w I format APDUs	1 to 8

Maximum range of values k: 1 to 32767 ($2^{15}-1$) APDUs, accuracy 1 APDU
 Maximum range of values w: 1 to 32767 ($2^{15}-1$) APDUs, accuracy 1 APDU
 (Recommendation: w should not exceed two-thirds of k).

Port number

Parameter	Value	Remarks
Port number	2404	In all cases

Redundant connections

Number N of redundancy group connections used

RFC 2200 suite

RFC 2200 is an official Internet Standard which describes the state of standardization of protocols used in the Internet as determined by the Internet Architecture Board (IAB). It offers a broad spectrum of actual standards used in the Internet. The suitable selection of documents from RFC 2200 defined in this standard for given projects has to be chosen by the user of this standard.

- Ethernet 802.3
- Serial X.21 interface
- Other selection from RFC 2200:

7 Support, Service & Warranty

In This Chapter

- ❖ Contacting Technical Support 129
- ❖ Return Material Authorization (RMA) Policies and Conditions..... 131
- ❖ LIMITED WARRANTY..... 133

Contacting Technical Support

ProSoft Technology, Inc. (ProSoft) is committed to providing the most efficient and effective support possible. Before calling, please gather the following information to assist in expediting this process:

- 1 Product Version Number
- 2 System architecture
- 3 Network details

If the issue is hardware related, we will also need information regarding:

- 1 Module configuration and associated ladder files, if any
- 2 Module operation and any unusual behavior
- 3 Configuration/Debug status information
- 4 LED patterns
- 5 Details about the serial, Ethernet or fieldbus devices interfaced to the module, if any.

Note: For technical support calls within the United States, an after-hours answering system allows 24-hour/7-days-a-week pager access to one of our qualified Technical and/or Application Support Engineers. Detailed contact information for all our worldwide locations is available on the following page.

Internet	Web Site: www.prosoft-technology.com/support E-mail address: support@prosoft-technology.com
Asia Pacific (location in Malaysia)	Tel: +603.7724.2080, E-mail: asiapc@prosoft-technology.com Languages spoken include: Chinese, English
Asia Pacific (location in China)	Tel: +86.21.5187.7337 x888, E-mail: asiapc@prosoft-technology.com Languages spoken include: Chinese, English
Europe (location in Toulouse, France)	Tel: +33 (0) 5.34.36.87.20, E-mail: support.EMEA@prosoft-technology.com Languages spoken include: French, English
Europe (location in Dubai, UAE)	Tel: +971-4-214-6911, E-mail: mea@prosoft-technology.com Languages spoken include: English, Hindi
North America (location in California)	Tel: +1.661.716.5100, E-mail: support@prosoft-technology.com Languages spoken include: English, Spanish
Latin America (Oficina Regional)	Tel: +1-281-2989109, E-Mail: latinam@prosoft-technology.com Languages spoken include: Spanish, English
Latin America (location in Puebla, Mexico)	Tel: +52-222-3-99-6565, E-mail: soporte@prosoft-technology.com Languages spoken include: Spanish
Brasil (location in Sao Paulo)	Tel: +55-11-5083-3776, E-mail: brasil@prosoft-technology.com Languages spoken include: Portuguese, English

7.1 Return Material Authorization (RMA) Policies and Conditions

The following Return Material Authorization (RMA) Policies and Conditions (collectively, "RMA Policies") apply to any returned product. These RMA Policies are subject to change by ProSoft Technology, Inc., without notice. For warranty information, see Limited Warranty (page 133). In the event of any inconsistency between the RMA Policies and the Warranty, the Warranty shall govern.

7.1.1 Returning Any Product

- a) In order to return a Product for repair, exchange, or otherwise, the Customer must obtain a Return Material Authorization (RMA) number from ProSoft Technology and comply with ProSoft Technology shipping instructions.
- b) In the event that the Customer experiences a problem with the Product for any reason, Customer should contact ProSoft Technical Support at one of the telephone numbers listed above (page 129). A Technical Support Engineer will request that you perform several tests in an attempt to isolate the problem. If after completing these tests, the Product is found to be the source of the problem, we will issue an RMA.
- c) All returned Products must be shipped freight prepaid, in the original shipping container or equivalent, to the location specified by ProSoft Technology, and be accompanied by proof of purchase and receipt date. The RMA number is to be prominently marked on the outside of the shipping box. Customer agrees to insure the Product or assume the risk of loss or damage in transit. Products shipped to ProSoft Technology using a shipment method other than that specified by ProSoft Technology, or shipped without an RMA number will be returned to the Customer, freight collect. Contact ProSoft Technical Support for further information.
- d) A 10% restocking fee applies to all warranty credit returns, whereby a Customer has an application change, ordered too many, does not need, etc. Returns for credit require that all accessory parts included in the original box (i.e.; antennas, cables) be returned. Failure to return these items will result in a deduction from the total credit due for each missing item.

7.1.2 Returning Units Under Warranty

A Technical Support Engineer must approve the return of Product under ProSoft Technology's Warranty:

- a) A replacement module will be shipped and invoiced. A purchase order will be required.
- b) Credit for a product under warranty will be issued upon receipt of authorized product by ProSoft Technology at designated location referenced on the Return Material Authorization
 - i. If a defect is found and is determined to be customer generated, or if the defect is otherwise not covered by ProSoft Technology's warranty, there will be no credit given. Customer will be contacted and can request module be returned at their expense;
 - ii. If defect is customer generated and is repairable, customer can authorize ProSoft Technology to repair the unit by providing a purchase order for 30% of the current list price plus freight charges, duties and taxes as applicable.

7.1.3 Returning Units Out of Warranty

- a) Customer sends unit in for evaluation to location specified by ProSoft Technology, freight prepaid.
- b) If no defect is found, Customer will be charged the equivalent of \$100 USD, plus freight charges, duties and taxes as applicable. A new purchase order will be required.
- c) If unit is repaired, charge to Customer will be 30% of current list price (USD) plus freight charges, duties and taxes as applicable. A new purchase order will be required or authorization to use the purchase order submitted for evaluation fee.

The following is a list of non-repairable units:

ScanPort Adapters

- 1500 - All
- 1550 - Can be repaired only if defect is the power supply
- 1560 - Can be repaired only if defect is the power supply

inRAx Modules

- 3150 - All
- 3170 - All
- 3250
- 3300
- 3350
- 3600 - All
- 3700
- 3750
- 3800-MNET

ProLinx Standalone Gateways

- 4xxx - All (No hardware available to do repairs)

7.2 LIMITED WARRANTY

This Limited Warranty ("Warranty") governs all sales of hardware, software, and other products (collectively, "Product") manufactured and/or offered for sale by ProSoft Technology, Incorporated (ProSoft), and all related services provided by ProSoft, including maintenance, repair, warranty exchange, and service programs (collectively, "Services"). By purchasing or using the Product or Services, the individual or entity purchasing or using the Product or Services ("Customer") agrees to all of the terms and provisions (collectively, the "Terms") of this Limited Warranty. All sales of software or other intellectual property are, in addition, subject to any license agreement accompanying such software or other intellectual property.

7.2.1 What Is Covered By This Warranty

- a) *Warranty On New Products:* ProSoft warrants, to the original purchaser, that the Product that is the subject of the sale will (1) conform to and perform in accordance with published specifications prepared, approved and issued by ProSoft, and (2) will be free from defects in material or workmanship; provided these warranties only cover Product that is sold as new. This Warranty expires three (3) years from the date of shipment for Product purchased **on or after** January 1st, 2008, or one (1) year from the date of shipment for Product purchased **before** January 1st, 2008 (the "Warranty Period"). If the Customer discovers within the Warranty Period a failure of the Product to conform to specifications, or a defect in material or workmanship of the Product, the Customer must promptly notify ProSoft by fax, email or telephone. In no event may that notification be received by ProSoft later than 39 months from date of original shipment. Within a reasonable time after notification, ProSoft will correct any failure of the Product to conform to specifications or any defect in material or workmanship of the Product, with either new or remanufactured replacement parts. ProSoft reserves the right, and at its sole discretion, may replace unrepairable units with new or remanufactured equipment. All replacement units will be covered under warranty for the 3 year period commencing from the date of original equipment purchase, not the date of shipment of the replacement unit. Such repair, including both parts and labor, will be performed at ProSoft's expense. All warranty service will be performed at service centers designated by ProSoft.
- b) *Warranty On Services:* Materials and labor performed by ProSoft to repair a verified malfunction or defect are warranted in the terms specified above for new Product, provided said warranty will be for the period remaining on the original new equipment warranty or, if the original warranty is no longer in effect, for a period of 90 days from the date of repair.

7.2.2 What Is Not Covered By This Warranty

- a) ProSoft makes no representation or warranty, expressed or implied, that the operation of software purchased from ProSoft will be uninterrupted or error free or that the functions contained in the software will meet or satisfy the purchaser's intended use or requirements; the Customer assumes complete responsibility for decisions made or actions taken based on information obtained using ProSoft software.
- b) This Warranty does not cover the failure of the Product to perform specified functions, or any other non-conformance, defects, losses or damages caused by or attributable to any of the following: (i) shipping; (ii) improper installation or other failure of Customer to adhere to ProSoft's specifications or instructions; (iii) unauthorized repair or maintenance; (iv) attachments, equipment, options, parts, software, or user-created programming (including, but not limited to, programs developed with any IEC 61131-3, "C" or any variant of "C" programming languages) not furnished by ProSoft; (v) use of the Product for purposes other than those for which it was designed; (vi) any other abuse, misapplication, neglect or misuse by the Customer; (vii) accident, improper testing or causes external to the Product such as, but not limited to, exposure to extremes of temperature or humidity, power failure or power surges; or (viii) disasters such as fire, flood, earthquake, wind and lightning.
- c) The information in this Agreement is subject to change without notice. ProSoft shall not be liable for technical or editorial errors or omissions made herein; nor for incidental or consequential damages resulting from the furnishing, performance or use of this material. The user guide included with your original product purchase from ProSoft contains information protected by copyright. No part of the guide may be duplicated or reproduced in any form without prior written consent from ProSoft.

7.2.3 Disclaimer Regarding High Risk Activities

Product manufactured or supplied by ProSoft is not fault tolerant and is not designed, manufactured or intended for use in hazardous environments requiring fail-safe performance including and without limitation: the operation of nuclear facilities, aircraft navigation or communication systems, air traffic control, direct life support machines or weapons systems in which the failure of the product could lead directly or indirectly to death, personal injury or severe physical or environmental damage (collectively, "high risk activities"). ProSoft specifically disclaims any express or implied warranty of fitness for high risk activities.

7.2.4 Intellectual Property Indemnity

Buyer shall indemnify and hold harmless ProSoft and its employees from and against all liabilities, losses, claims, costs and expenses (including attorney's fees and expenses) related to any claim, investigation, litigation or proceeding (whether or not ProSoft is a party) which arises or is alleged to arise from Buyer's acts or omissions under these Terms or in any way with respect to the Products. Without limiting the foregoing, Buyer (at its own expense) shall indemnify and hold harmless ProSoft and defend or settle any action brought against such Companies to the extent based on a claim that any Product made to Buyer specifications infringed intellectual property rights of another party. ProSoft makes no warranty that the product is or will be delivered free of any person's claiming of patent, trademark, or similar infringement. The Buyer assumes all risks (including the risk of suit) that the product or any use of the product will infringe existing or subsequently issued patents, trademarks, or copyrights.

- a) Any documentation included with Product purchased from ProSoft is protected by copyright and may not be duplicated or reproduced in any form without prior written consent from ProSoft.
- b) ProSoft's technical specifications and documentation that are included with the Product are subject to editing and modification without notice.
- c) Transfer of title shall not operate to convey to Customer any right to make, or have made, any Product supplied by ProSoft.
- d) Customer is granted no right or license to use any software or other intellectual property in any manner or for any purpose not expressly permitted by any license agreement accompanying such software or other intellectual property.
- e) Customer agrees that it shall not, and shall not authorize others to, copy software provided by ProSoft (except as expressly permitted in any license agreement accompanying such software); transfer software to a third party separately from the Product; modify, alter, translate, decode, decompile, disassemble, reverse-engineer or otherwise attempt to derive the source code of the software or create derivative works based on the software; export the software or underlying technology in contravention of applicable US and international export laws and regulations; or use the software other than as authorized in connection with use of Product.
- f) **Additional Restrictions Relating To Software And Other Intellectual Property**

In addition to compliance with the Terms of this Warranty, Customers purchasing software or other intellectual property shall comply with any license agreement accompanying such software or other intellectual property. Failure to do so may void this Warranty with respect to such software and/or other intellectual property.

7.2.5 Disclaimer of all Other Warranties

The Warranty set forth in What Is Covered By This Warranty (page 133) are in lieu of all other warranties, express or implied, including but not limited to the implied warranties of merchantability and fitness for a particular purpose.

7.2.6 Limitation of Remedies **

In no event will ProSoft or its Dealer be liable for any special, incidental or consequential damages based on breach of warranty, breach of contract, negligence, strict tort or any other legal theory. Damages that ProSoft or its Dealer will not be responsible for include, but are not limited to: Loss of profits; loss of savings or revenue; loss of use of the product or any associated equipment; loss of data; cost of capital; cost of any substitute equipment, facilities, or services; downtime; the claims of third parties including, customers of the Purchaser; and, injury to property.

** Some areas do not allow time limitations on an implied warranty, or allow the exclusion or limitation of incidental or consequential damages. In such areas, the above limitations may not apply. This Warranty gives you specific legal rights, and you may also have other rights which vary from place to place.

7.2.7 Time Limit for Bringing Suit

Any action for breach of warranty must be commenced within 39 months following shipment of the Product.

7.2.8 No Other Warranties

Unless modified in writing and signed by both parties, this Warranty is understood to be the complete and exclusive agreement between the parties, suspending all oral or written prior agreements and all other communications between the parties relating to the subject matter of this Warranty, including statements made by salesperson. No employee of ProSoft or any other party is authorized to make any warranty in addition to those made in this Warranty. The Customer is warned, therefore, to check this Warranty carefully to see that it correctly reflects those terms that are important to the Customer.

7.2.9 Allocation of Risks

This Warranty allocates the risk of product failure between ProSoft and the Customer. This allocation is recognized by both parties and is reflected in the price of the goods. The Customer acknowledges that it has read this Warranty, understands it, and is bound by its Terms.

7.2.10 Controlling Law and Severability

This Warranty shall be governed by and construed in accordance with the laws of the United States and the domestic laws of the State of California, without reference to its conflicts of law provisions. If for any reason a court of competent jurisdiction finds any provisions of this Warranty, or a portion thereof, to be unenforceable, that provision shall be enforced to the maximum extent permissible and the remainder of this Warranty shall remain in full force and effect. Any cause of action with respect to the Product or Services must be instituted in a court of competent jurisdiction in the State of California.

Index

[

[IEC-60870-5-104 Client Commands] • 28
[IEC-60870-5-104 Client x Sector x] Parameters • 24
[IEC-60870-5-104 Client x Sector y] • 26
[IEC-60870-5-104 Client x] • 21
[IEC-870-5-104] • 19
[M_BO_NA_1 104] • 27
[SNTP CLIENT] • 17, 98

1

104 Server Specifications • 109

A

ACTTERM with Set Point • 23
Allocation of Risks • 136
Application Data Area • 106
Application Layer • 118

B

Background scan • 127
Basic Application Functions • 122

C

C_BO_NA • 61
C_DC_NA • 59
C_RC_NA • 60
C_SC_NA • 58
C_SE_NA and C_SE_NB • 62
C_SE_NC • 63
Cause of transmission • 118
Client X Status Data Mailbox (9251) • 78
Clock synchronization • 124
Coldboot Mailbox (9998/9999) • 88
Command Control Block Mailbox (9902) • 72
Command List Error Data Mailbox (9950) • 81
Command transmission • 125
Common Address of ASDU • 118
Common ASDU Address • 24
Configuring the Gateway • 15
Contacting Technical Support • 129, 131
Control Information Objects Addressing • 58
Controlling Law and Severability • 136
Creating Optional Comment Entries • 40
Cyclic data transmission • 122

D

Data Type • 30
Database Address • 29
Database Configuration • 97
Database Register • 19

Database View Menu • 97, 99
Definition of time outs • 127
Delay Preset • 38
Diagnostics and Troubleshooting • 9, 91
Disclaimer of all Other Warranties • 135
Disclaimer Regarding High Risk Activities • 134
Displaying the Current Page of Registers Again • 100
Double transmission of information objects with cause
of transmission spontaneous • 123
Downloading a File from PC to the Module • 39
Driver Protocol Specifications • 109
Driver Status Offset • 20

E

Enable Code • 28
EOI General Int • 25
EOI Time Sync • 25
Ethernet LED Indicators • 92
Event Messages from Outstations Mailbox (9903) • 73
Exiting the Program • 99

F

File transfer • 121, 127
From Address • 36

G

General Gateway Status Mailbox (9250) • 76
General Specifications • 106
Get Gateway Time Mailbox (9970) • 83
Guide to the 104C Module Protocol Manual • 9

H

Hardware Specifications • 108
How to Contact Us • 2

I

IEC 60870-5-104 Client Interoperability Statement •
117
IEC 60870-5-104 Client Section • 16
IEC-60870-5-104 Protocol Implementation • 43
IEC-870-5-104 Client Menu • 101
IEC-870-5-104 Configuration Menu • 102
IEC-870-5-104 Status Data • 103
Important Installation Instructions • 3
Information object address • 118
Installing ProSoft Configuration Builder Software • 13
Intellectual Property Indemnity • 135
Internal Database • 106
IP Address • 44

K

k (maximum queue) • 22
Keystrokes • 96

L

Length of APDU • 118
Limitation of Remedies ** • 136

LIMITED WARRANTY • 131, 133

M

M_BO_NA • 53
M_DP_NA • 51
M_ME_NA and M_ME_NB • 54
M_ME_NC and M_IT_NA • 56
M_SP_NA • 50
M_ST_NA • 52
Mailbox Feature (x201-DFNT-104C) • 67
Mailbox Offset • 20
Main Menu • 97
Markings • 4
Maximum number of outstanding I format APDUs k
and latest acknowledge APDUs (w) • 128
Module Address • 44
Monitor Direction and Control Direction
Information Object Definition • 46
Monitor Double Point [M_DP_NA] • 27
Monitor Information Objects Addressing • 49
Monitor Integrated Totals (Counter) [M_IT_NA] • 27
Monitor Normalized Measured [M_ME_NA] • 27
Monitor Scaled Measured [M_ME_NB] • 27
Monitor Short Floating-Point [M_ME_NC] • 27
Monitor Single Point [M_SP_NA] • 27
Monitor Step Position [M_ST_NA] • 27
Moving Back Through 5 Pages of Registers • 100
Moving Forward (Skipping) Through 5 Pages of
Registers • 100

N

Navigation • 96
Network Menu • 99, 104
No Other Warranties • 136

O

Online General Int • 24
Online Time Sync • 24
Opening the Database View Menu • 97
Opening the IEC 870-5-104 Client Menu • 99
Opening the Network Menu • 99
Optional Web Server for Ethernet Solutions • 107
Originator address for COT • 22

P

Parameter activation • 126
Parameter in control direction • 121
Parameter loading • 126
Pass-Through Events • 21
Pinouts • 3
Point Index • 31
Poll Interval • 30
Port number • 128
Port Physical and Protocol Specifications • 109
Printing a Configuration File • 41
Process information in control direction • 120
Process information in monitor direction • 119
Product Specifications • 9, 106

ProLinX Gateways with Ethernet Ports • 3
ProLinX Reference Guide • 12
ProLinX® Products Warnings • 3
ProSoft Technology® Product Documentation • 2

Q

Qualifier Parameter • 31

R

Read procedure • 123
Redisplaying the Menu • 96
Redundant connections • 128
Reference • 9, 105
Register Count • 36
Required Hardware • 93
Reset Status Data Mailbox (9997) • 87
Resetting Diagnostic Data • 98
Response Timeout • 23
Return Material Authorization (RMA) Policies and
Conditions • 131
Returning Any Product • 131
Returning to the Main Menu • 101, 104
Returning Units Out of Warranty • 132
Returning Units Under Warranty • 132
RFC 2200 suite • 128

S

Sector • 30
Sector Count - 1 to 2 • 21
Selection of standard ASDUs • 119
Sending the Configuration File • 98
Server Error and Status Data • 111
Server Functional Specifications • 109
Server IP Address • 21
Session • 30
Set Gateway Time Mailbox (9971) • 85
SNTP Server IP Address • 18
SNTP Status Data • 110
SNTP Support • 110
Spontaneous transmission • 123
Start Here • 9, 11
Station initialization • 122
Station Interrogation • 124
Status Data Area • 106
Status Offset • 23
Support, Service & Warranty • 9, 129
Swap Code • 37
System information in control direction • 120
System information in monitor direction • 120
System or device • 117

T

t0 Connection Timeout • 22
t1 Timeout Set Value • 22
t2 Timeout Set Value • 22
t3 Timeout Set Value • 22
Test procedure • 127
TESTFR Requests • 64

Time DB Offset • 20
Time Limit for Bringing Suit • 136
Time Zone • 19
To Address • 36
To order a ProLinX Plus gateway with the -WEB option
• 3
To upgrade a previously purchased Series C model • 3
Transmission mode for application data • 118
Transmission of Integrated totals • 126
Type identifier and cause of transmission assignments
• 122

U

Use Daylight Savings Time • 19
User Constructed Command Mailbox (9901) • 70
Using Control (Command) Information Objects • 57
Using Monitor Points • 49
Using ProSoft Configuration Builder (PCB) for
Diagnostics • 93
Using the CommonNet Data Map • 35
Using the Diagnostic Window in ProSoft Configuration
Builder • 93
Using the Online Help • 13

V

Viewing Data in ASCII (Text) Format • 101
Viewing Data in Decimal Format • 101
Viewing Data in Floating-Point Format • 101
Viewing Data in Hexadecimal Format • 101
Viewing Register Pages • 100
Viewing SNTP Status • 98
Viewing the Next Page of Registers • 100
Viewing the Previous Page of Registers • 100
Viewing the WATTCP.CFG File on the gateway • 104
Viewing Version Information • 98
Viewing Command Lists • 102, 103

W

w (latest ack threshold) • 22
What Is Covered By This Warranty • 133, 135
What Is Not Covered By This Warranty • 134

Y

Your Feedback Please • 2