



104 Protocol IEC 60870-5-104 Server

August 1, 2024

Your Feedback Please

We always want you to feel that you made the right decision to use our products. If you have suggestions, comments, compliments or complaints about our products, documentation, or support, please write or call us.

How to Contact Us

ProSoft Technology, Inc.
+1 (661) 716-5100
+1 (661) 716-5101 (Fax)
www.prosoft-technology.com
support@prosoft-technology.com

104 Protocol User Manual
For Public Use.

August 1, 2024

ProSoft Technology®, is a registered copyright of ProSoft Technology, Inc. All other brand or product names are or may be trademarks of, and are used to identify products and services of, their respective owners.

Content Disclaimer

This documentation is not intended as a substitute for and is not to be used for determining suitability or reliability of these products for specific user applications. It is the duty of any such user or integrator to perform the appropriate and complete risk analysis, evaluation and testing of the products with respect to the relevant specific application or use thereof. Neither ProSoft Technology nor any of its affiliates or subsidiaries shall be responsible or liable for misuse of the information contained herein. Information in this document including illustrations, specifications and dimensions may contain technical inaccuracies or typographical errors. ProSoft Technology makes no warranty or representation as to its accuracy and assumes no liability for and reserves the right to correct such inaccuracies or errors at any time without notice. If you have any suggestions for improvements or amendments or have found errors in this publication, please notify us.

No part of this document may be reproduced in any form or by any means, electronic or mechanical, including photocopying, without express written permission of ProSoft Technology. All pertinent state, regional, and local safety regulations must be observed when installing and using this product. For reasons of safety and to help ensure compliance with documented system data, only the manufacturer should perform repairs to components. When devices are used for applications with technical safety requirements, the relevant instructions must be followed. Failure to use ProSoft Technology software or approved software with our hardware products may result in injury, harm, or improper operating results. Failure to observe this information can result in injury or equipment damage.

Copyright © 2024 ProSoft Technology, Inc. All Rights Reserved.



For professional users in the European Union

If you wish to discard electrical and electronic equipment (EEE), please contact your dealer or supplier for further information.



Prop 65 Warning – Cancer and Reproductive Harm – www.P65Warnings.ca.gov

Important Installation Instructions

Power, Input, and Output (I/O) wiring must be in accordance with Class I, Division 2 wiring methods, Article 501-4 (b) of the National Electrical Code, NFPA 70 for installation in the U.S., or as specified in Section 18-1J2 of the Canadian Electrical Code for installations in Canada, and in accordance with the authority having jurisdiction. The following warnings must be heeded:

WARNING - EXPLOSION HAZARD - SUBSTITUTION OF COMPONENTS MAY IMPAIR SUITABILITY FOR CLASS I, DIV. 2;

WARNING - EXPLOSION HAZARD - WHEN IN HAZARDOUS LOCATIONS, TURN OFF POWER BEFORE REPLACING OR WIRING MODULES

WARNING - EXPLOSION HAZARD - DO NOT DISCONNECT EQUIPMENT UNLESS POWER HAS BEEN SWITCHED OFF OR THE AREA IS KNOWN TO BE NON-HAZARDOUS.

Class 2 Power

Agency Approvals and Certifications

Please visit our website: www.prosoft-technology.com

Contents

Your Feedback Please	2
How to Contact Us.....	2
Content Disclaimer	2
Important Installation Instructions.....	3
Agency Approvals and Certifications.....	3
Contents	4
1 About the PLX32 Gateway	6
1.1 Product Specifications	6
1.1.1 Internal Database.....	6
1.1.2 Hardware Specifications	8
1.1.3 Port Physical and Protocol Specifications	9
2 ProSoft Configuration Builder	10
2.1 Setting Up the Project.....	10
2.2 Ethernet Configuration.....	12
2.3 CommonNet Data Map	14
2.4 Downloading a File from PC to the Gateway.....	17
3 IEC-60870-5-104 (104S) Protocol Implementation	19
3.1 IEC 60870-5-104 Server	20
3.1.1 SNTP CLIENT.....	21
3.1.2 IEC-870-5-104	23
3.1.3 IEC-870-5-104 Priority	30
3.1.4 IEC-870-5-104 Database.....	32
3.1.5 IEC-870-5-104 IP Addresses	36
3.1.6 Window Parameters	37
3.1.7 Point List	38
3.2 Monitor Direction and Control Direction: Point Definition.....	41
3.3 Using Monitor Points.....	43
3.3.1 Monitor Data Transfer.....	44
3.3.2 Monitor Points Addressing.....	51
3.4 Using Control (Command) Points	57
3.4.1 Control Data Transfer	59
3.4.2 Command Points Addressing	60
3.4.3 Examples	65
3.5 Data Communication	67
3.5.1 Group Communication.....	67
3.5.2 STARTDT & STOPDT	69
3.5.3 TESTFR Requests.....	70
3.6 Events	73
3.6.1 Deadbands.....	74
3.6.2 Controlling the Generation of Events.....	79
3.6.3 Event Priority.....	81
3.6.4 Invalid Bit Monitoring.....	83

3.6.5	Time Information	86
3.7	Sequence Flag.....	87
4	Diagnostics and Troubleshooting	88
4.1	Configuration/Debug Menu.....	88
4.1.1	Using the Diagnostic Window in ProSoft Configuration Builder.....	88
4.1.2	IEC 60870-5-104 Server Menu.....	90
4.2	LED Indicators	93
4.2.1	Status LEDs	93
4.2.2	Ethernet Port LEDs	93
4.2.3	PLX32-EIP-104 (only) LEDs	94
5	Reference	95
5.1	Command Block Functionality	95
5.1.1	Introduction	95
5.1.2	Configuration.....	95
5.1.3	Command Block List.....	98
5.1.4	Event Data Command Block.....	105
5.1.5	Set Time Command Block	107
5.1.6	Get Time Command Block.....	108
5.1.7	Get Event Buffer Sizes Command Block	109
5.2	SNTP Status Data.....	110
5.3	Server Error and Status Data.....	111
5.4	Command Qualifiers	113
5.5	Parameter Qualifiers	113
5.6	IEC 60870-5-104 Server Interoperability Document.....	113
5.6.1	System or device	114
5.6.2	Application Layer	115
5.6.3	Selection of standard ASDUs	116
5.6.4	Type identifier and cause of transmission assignments	119
5.6.5	Basic Application Functions	120
6	Support, Service & Warranty	125
6.1	Contacting Technical Support.....	125
6.2	Warranty Information	125

1 About the PLX32 Gateway

The PLX32-EIP-104 and PLX32-MBTCP-104 gateways have dual Ethernet ports, allowing for one protocol to communicate on each Ethernet port, or both protocols sharing one Ethernet port.

The gateway provides powerful communications on EtherNet/IP and Modbus TCP/IP networks, each operating as either a Client or a Server to various devices such as PLC's, Drives, and various other equipment.

On the IEC 60870-5-104 side of the communications, the gateway operates as a server, such as a SCADA system or DCS system.

Up to 10,000 words of user-defined memory to share data between IEC 60870-5-104 and EtherNet/IP or Modbus TCP/IP networks.

1.1 Product Specifications

1.1.1 Internal Database

The PLX32 gateway contains a 10,000 register internal database that consists of areas for application data, status information, and configuration information.

The internal database is shared between all ports on the gateway and is used as a conduit to pass information from a device on one network to one or more devices on another network.

Example 1: PLX32-EIP-104 Network

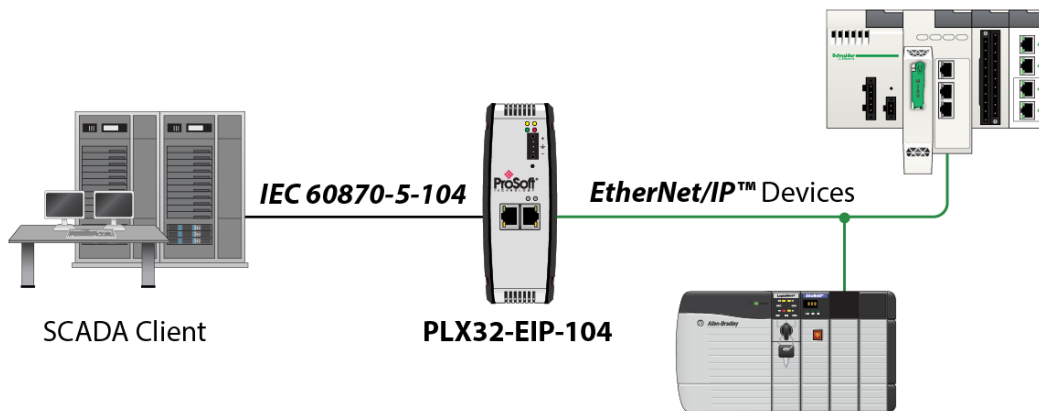

Example 2: PLX32-MBTCP-104 Network

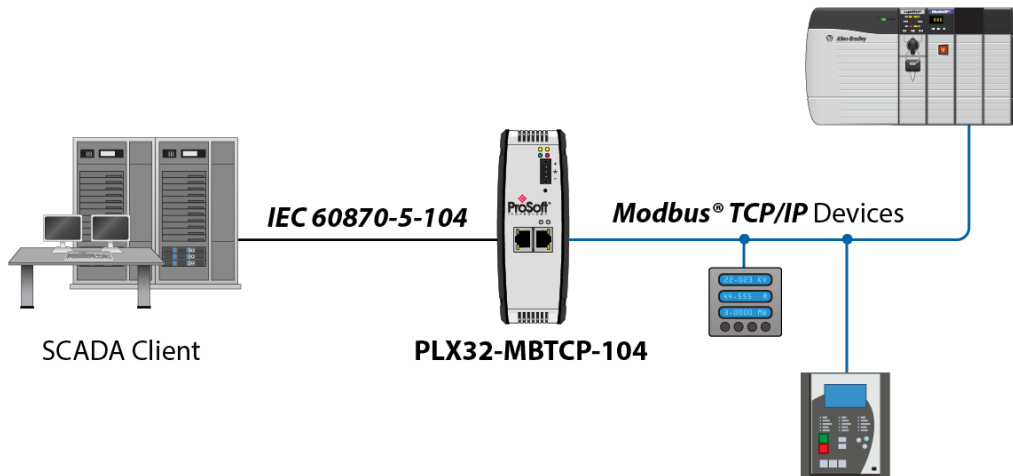

Application Data Area

The protocol drivers exchange data by storing and retrieving data from a shared application memory data area. The database (registers 0 to 9999) is used as a source for data to be sent to remote devices and holds data received from the remote devices. For protocol drivers that act as Clients, commands defined in the configuration file control how the data is to be handled in the database. For protocol drivers that act as Servers, the remote Client must be properly configured to send data to or request data from the correct memory addresses in the gateway application data area.

Status Data Area

This area stores error codes, counters, and other status information of the 104 Driver. This data area is located at a virtual addressing area, above the 10,000 register user database area. The status can be remapped from the virtual database area to the user database area. For further information about this topic, please refer to the *Server Error and Status Data* section on page 111.

1.1.2 Hardware Specifications

Specification	Description
Power Supply	24 VDC nominal 10 to 36 VDC allowed Positive, Negative, GND Terminals
Current Load	24 VDC nominal @ 300 mA 10 to 36 VDC @ 610 mA maximum
Operating Temperature	-25°C to 70°C (-13°F to 158°F)
Storage Temperature	-40°C to 80°C (-40°F to 176°F)
Humidity	IEC 60068-30; 5% to 95%, with no condensation
Shock	IEC 60068-2-27; 15G @ 11ms (Operational) IEC 60068-2-27; 30G @ 11ms (Non-Operational)
Vibration	IEC 60068-2-6; 5G @ 10 to 150 Hz
Dimensions (H x W x D)	5.38 x 1.99 x 4.38 in 13.67 x 5.05 x 11.13 cm
Ethernet Port	(2) 10/100 Base-T, RJ45 connector
SD Card	(Optional) Maximum supported size 32GB (located at back of gateway)

1.1.3 Port Physical and Protocol Specifications

104 Server Specifications

- Supports storage and transfer of up to 10,000 registers between protocols
- User-definable gateway memory usage
- IEC time used by the gateway can be stored in the memory database
- Configures via ProSoft Configuration Builder Software (PCB)
- Protocol implementation conforms to the IEC-870-5-104 specification
- Event Priority Queues available
- Invalid Bit Monitoring available
- Supports Redundant Connections

Driver Protocol Specifications General Parameters

Parameter	Description
Internal Database	10,000 registers (words) available
Communication parameters	10/100 Base-T full and half duplex RJ45 Connector Link and Activity LED indicators
Status Data	Status data is returned in a block of counter values allowing communications to be effectively debugged.
Conformance Specifications	See IEC 60870-5-104 Server Interoperability Document (page 127)

Server Functional Specifications

The PLX32 gateway accepts commands from one or more remote Client units on the Ethernet network and generates unsolicited messages to the Clients.

Unsolicited messages can be sent based on data change events or on a timed cycle. Data transferred to the Client comes from the gateway's internal database. Remote Client devices use the IEC-870-5-104 protocol to control outputs and monitor inputs using the fully-configurable gateway application database. The remote Client devices can overwrite data in the database and, thereby, pass control data to devices connected to the gateway using standard control messages supported by the other gateway protocol.

2 ProSoft Configuration Builder

This chapter covers the features within the ProSoft Configuration Builder (PCB) software. You can download PCB at www.prosoft-technology.com

2.1 Setting Up the Project

If you have used other Windows configuration tools before, you will find the screen layout familiar. The ProSoft Configuration Builder window consists of a tree view on the left, an information pane, and a configuration pane on the right side of the window.

When you first start PCB, the tree view consists of folders for *Default Project* and *Default Location*, with a *Default Module* in the *Default Location* folder. The following illustration shows the PCB window with a new project.

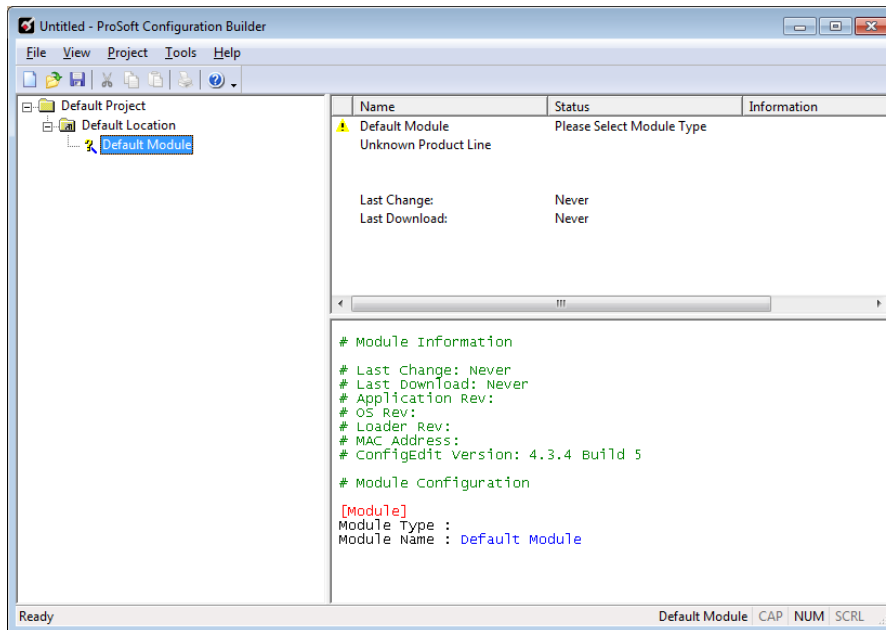

To add the gateway to the project

- 1 Right-click **DEFAULT MODULE** in the tree view, and then choose **CHOOSE MODULE TYPE**. This opens the *Choose Module Type* dialog box.

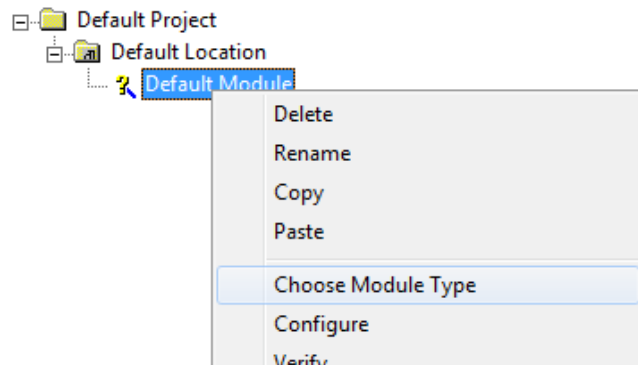

- 2 In the *Product Line Filter* area of the dialog box, select the **PLX30** radio button.

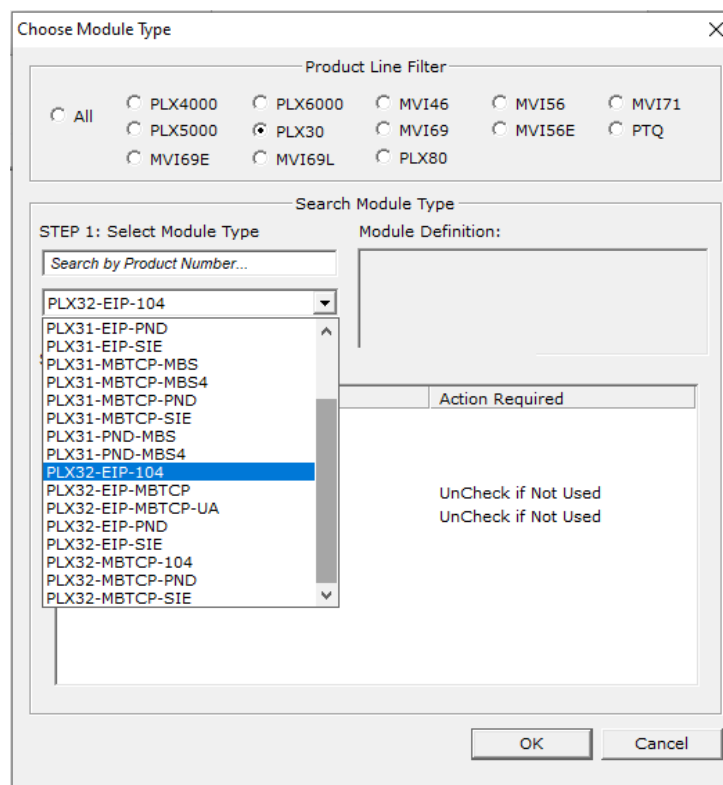

- 3 In the *STEP 1: Select Module Type* dropdown list, select **PLX32-EIP-104** or **PLX32-MBTCP-104**.
- 4 Click **OK** to save your settings and return to the PCB Main window.

2.2 Ethernet Configuration

The PLX32 gateway is identified at transport level (using the IP Address) and at application level (using the Common ASDU Address).

The PLX32 gateway is identified by a unique IP address per physical port on the TCP/IP network. You must edit the Ethernet configuration to enter a valid IP address.

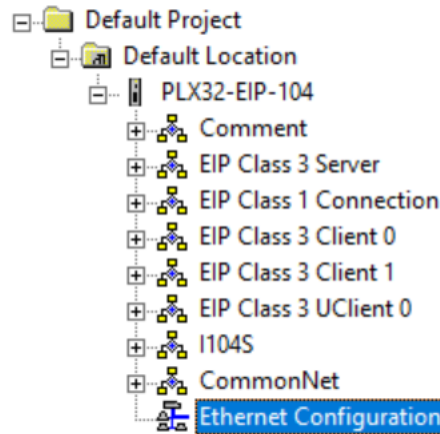

The *Ethernet Configuration* dialog allows you to select the number of ports (1 or 2) for the application.

If **1 Port** is selected, both protocols will be assigned to Port 1, and Port 2 is not used.

Port	IEC-104	EIP	IP Address	Subnet Mask	Default Gateway
E1	<input checked="" type="checkbox"/>	<input checked="" type="checkbox"/>	192 . 168 . 0 . 31	255 . 255 . 255 . 0	192 . 168 . 0 . 1
E2	<input type="checkbox"/>	<input type="checkbox"/>	192 . 168 . 1 . 250	255 . 255 . 255 . 0	192 . 168 . 1 . 1

If **2 Ports** is selected, each port will be assigned a protocol.

Note: For the PLX32-EIP-104 product, the EIP protocol is always assigned to Port 1. If the 2 Port option is selected, the IEC-104 protocol is assigned to port 2.

In this example, the PLX32 gateway is identified by IP address 192.168.0.250 in the IEC-60870-5-104 network, with a netmask (subnet mask) of 255.255.255.0 and a default gateway address of 192.168.0.1.

Because there could be several devices in the same TCP/IP network, some applications may require a connection control (from which IP addresses the gateway may receive valid messages).

Parameter	Description
Number of Ports	1 or 2 Ethernet ports used
ETH 1	EIP or MBTCP protocol used on this port
ETH 2	IEC-104 Protocol used on this port
ETH1_IP	IP address for ETH1 port
ETH1_Netmask	Network mask for ETH1 port
ETH1_Gateway	Gateway for ETH1 port
ETH2_IP	IP address for ETH2 port
ETH2_Netmask	Network mask for ETH2 port
ETH2_Gateway	Gateway for ETH2 port

2.3 CommonNet Data Map

DATA MAP allows you to copy data between areas in the gateway's internal database.

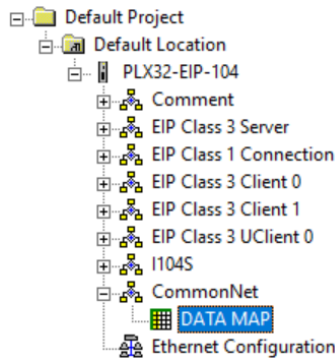

You can copy a maximum of 100 registers per Data Map command, and you can configure a maximum of 200 separate copy commands.

For example, you can copy data from the error or status tables in upper memory to internal database registers in the User Data memory area.

The byte and/or word order can be rearranged during the copy process. For example, to convert floating-point values to the correct format for a different protocol.

The Data Map can be used to condense widely dispersed data into one contiguous data block, making it easier to access.

The Data Map supports the conversion of user data from Integer to Floating-point data and vice-versa along with arithmetic operations such as Divide, Multiply, Add, and Subtract.

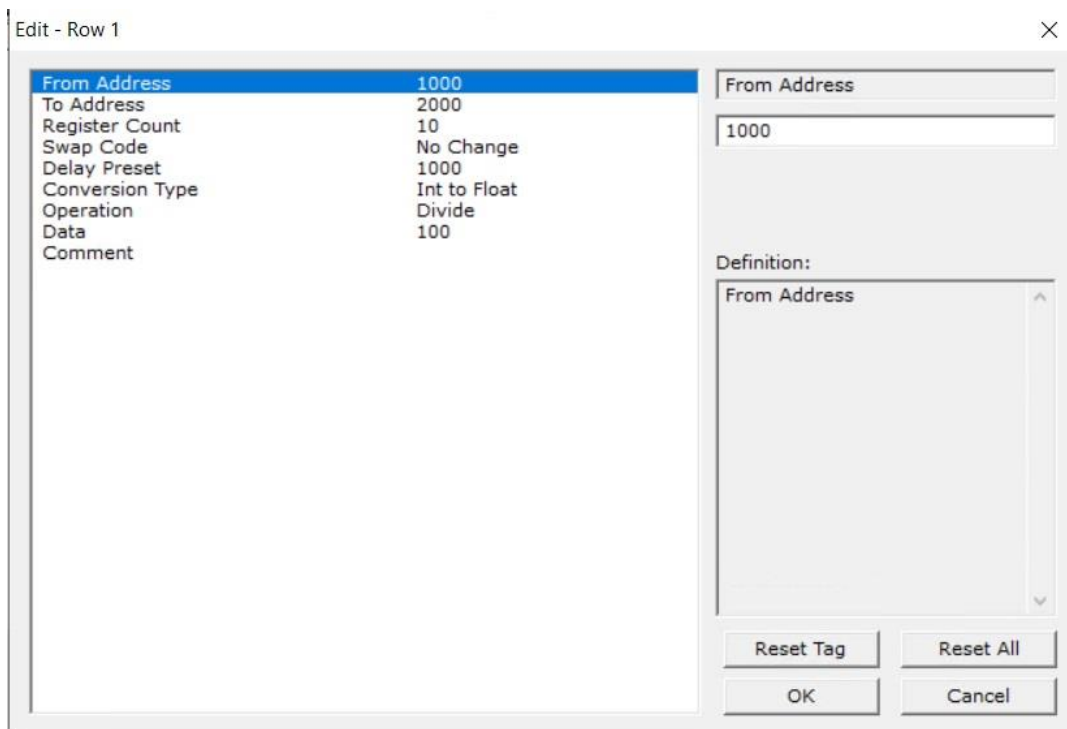

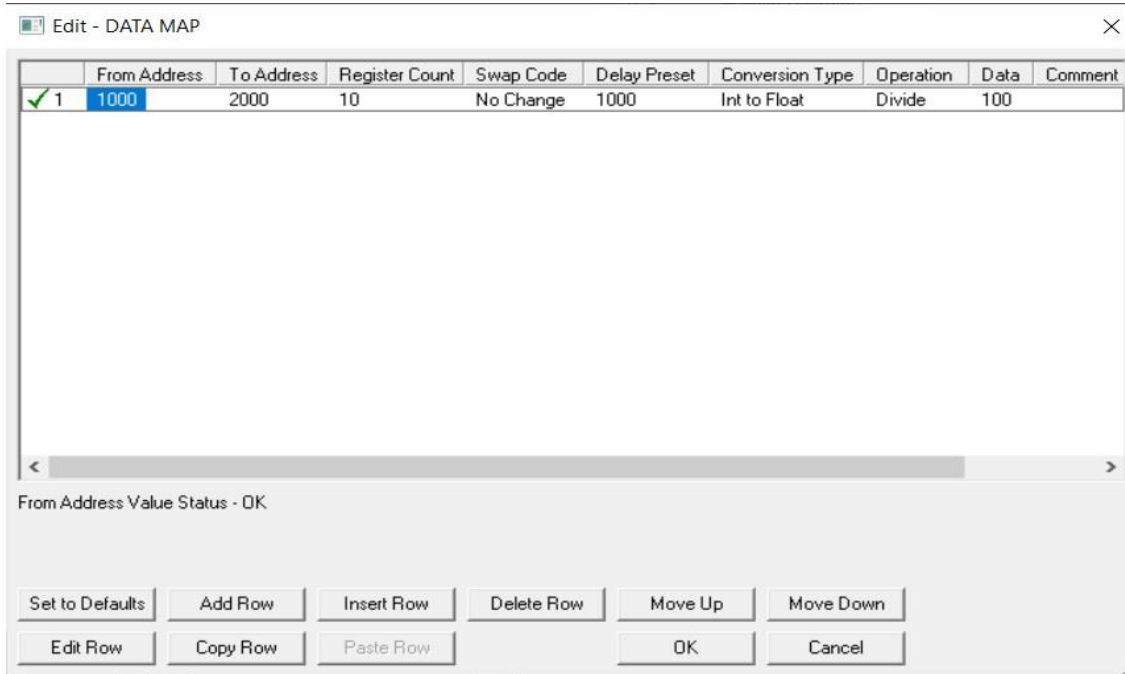

Parameter	Range	Description										
From Address	0 to highest Status Data address	This field specifies the internal database register to copy from. This address can range from the Data area as well as the Status Data Area of the product.										
To Address	0 to 9999	The destination for the copy is always within the User Data registers area. Take care to specify a destination address that will not overwrite data that may be required for other purposes.										
Register Count	1 to 100	This parameter specifies the number of registers to copy.										
Swap Code	No Change, Word Swap, Word and Byte Swap, Byte Swap	You may need to swap the order of the bytes in the registers during the copy process to change the alignment of bytes between dissimilar protocols. This parameter is helpful when dealing with floating-point or other multi-register values, as there is no standard method of storage of these data types in slave devices.										
		<table border="1"> <thead> <tr> <th>Swap Code</th> <th>Description</th> </tr> </thead> <tbody> <tr> <td>No Swap</td> <td>No Change is made in the byte ordering (1234 = 1234)</td> </tr> <tr> <td>Word Swap</td> <td>The words are swapped (1234 = 3412)</td> </tr> <tr> <td>Word and Byte Swap</td> <td>The words are swapped then the bytes in each word are swapped (1234 = 4321)</td> </tr> <tr> <td>Bytes</td> <td>The bytes in each word are swapped (1234 = 2143)</td> </tr> </tbody> </table>	Swap Code	Description	No Swap	No Change is made in the byte ordering (1234 = 1234)	Word Swap	The words are swapped (1234 = 3412)	Word and Byte Swap	The words are swapped then the bytes in each word are swapped (1234 = 4321)	Bytes	The bytes in each word are swapped (1234 = 2143)
Swap Code	Description											
No Swap	No Change is made in the byte ordering (1234 = 1234)											
Word Swap	The words are swapped (1234 = 3412)											
Word and Byte Swap	The words are swapped then the bytes in each word are swapped (1234 = 4321)											
Bytes	The bytes in each word are swapped (1234 = 2143)											
Delay Preset	0 to 32,000 milliseconds	This parameter sets an interval for each Data Map copy operation. It is the number of firmware scans that must transpire between copy operations. If multiple copy operations (several rows in the Data map section) happen too frequently or all happen in the same update interval, they could delay the process scan of the gateway protocols, which could result in slow data updates or missed data on communication										

		<p>ports. To avoid these potential problems, you should set the DELAY PRESET to different values for each row in the Data Map section and set them to higher, rather than lower, numbers. For example, DELAY PRESET values below 1000 could begin to cause a noticeable delay in data updates through the communication ports. And you should not set all DELAY PRESETS to the same value. Instead, use different values for each row in the Data Map such as 1000, 1001, and 1002 or any other different DELAY PRESET values you like. This will prevent the copies from happening concurrently and prevent possible process scan delays.</p>												
Conversion Type	Disable, Int to Float, Float to Int	<p>This parameter specifies the conversion that can be performed on the data.</p> <table border="1"> <thead> <tr> <th>Type</th> <th>Description</th> </tr> </thead> <tbody> <tr> <td>Disable</td> <td>Conversion is disabled.</td> </tr> <tr> <td>Int to Float</td> <td>Integer data type converted to Float data type.</td> </tr> <tr> <td>Float to Int</td> <td>Float data type converted to Int data type.</td> </tr> </tbody> </table> <p>If the Conversion Type is Int to Float then From Address is based on 1-Word addressing and To Address is based on 2-Word addressing whereas, if the Conversion Type is Float to Int then both From Address and To Address are based on 2-Word addressing.</p> <p>Note: The Swap Code does not work when the Conversion Type is either Int to Float or Float to Int. It works only when the Conversion Type is disabled.</p>	Type	Description	Disable	Conversion is disabled.	Int to Float	Integer data type converted to Float data type.	Float to Int	Float data type converted to Int data type.				
Type	Description													
Disable	Conversion is disabled.													
Int to Float	Integer data type converted to Float data type.													
Float to Int	Float data type converted to Int data type.													
Operation	None, Divide, Multiply, Add, Subtract	<p>This parameter specifies the arithmetic operation that can be performed on the data.</p> <table border="1"> <thead> <tr> <th>Operation</th> <th>Description</th> </tr> </thead> <tbody> <tr> <td>None</td> <td>No operation is performed.</td> </tr> <tr> <td>Divide</td> <td>Division operation is performed on the data.</td> </tr> <tr> <td>Multiply</td> <td>Multiplication operation is performed on the data.</td> </tr> <tr> <td>Add</td> <td>Addition operation is performed on the data.</td> </tr> <tr> <td>Subtract</td> <td>Subtraction operation is performed on the data.</td> </tr> </tbody> </table> <p>Operation is applicable only when the Conversion Type is enabled.</p>	Operation	Description	None	No operation is performed.	Divide	Division operation is performed on the data.	Multiply	Multiplication operation is performed on the data.	Add	Addition operation is performed on the data.	Subtract	Subtraction operation is performed on the data.
Operation	Description													
None	No operation is performed.													
Divide	Division operation is performed on the data.													
Multiply	Multiplication operation is performed on the data.													
Add	Addition operation is performed on the data.													
Subtract	Subtraction operation is performed on the data.													
Data	0 to 65535	<p>This parameter specifies the value with which data at the "From Address" is Divided/ Multiplied/Added/Subtracted by (based on the operation selected). The result of the operation is displayed at the "To Address".</p> <p>Data is applicable only when Conversion Type is enabled and Operation is not set to None.</p>												

2.4 Downloading a File from PC to the Gateway

- 1 In PCB, right-click on the PLX32 gateway icon and click on **DOWNLOAD FROM PC TO DEVICE**.

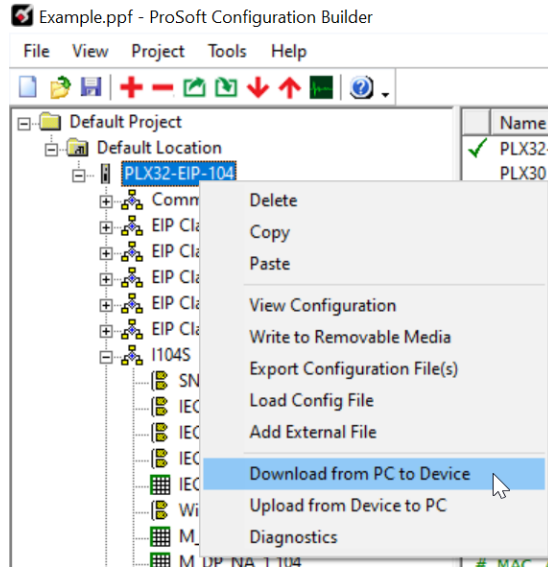

- 2 In the *Download file from PC to module* dialog, click on the **BROWSE DEVICE(S)** button.

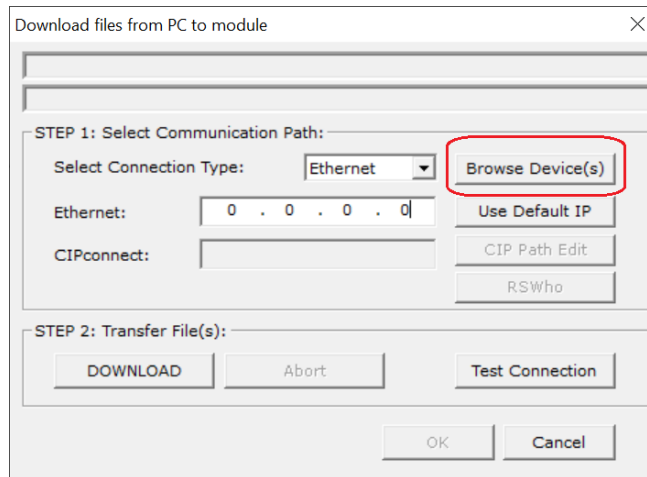

- 3 The *ProSoft Discovery Service* utility will search and find the ProSoft Technology devices on the network.

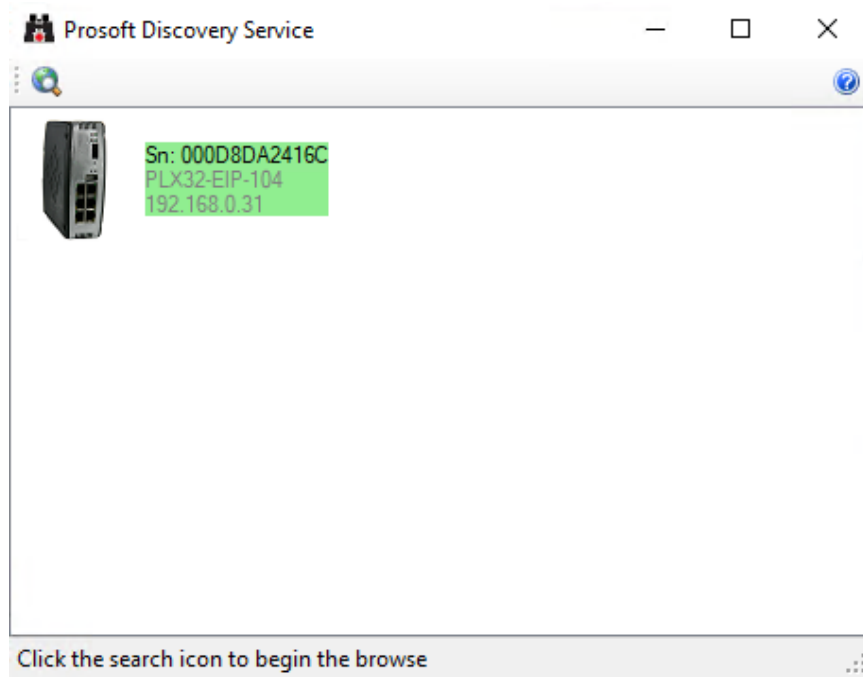

- 4 Select the PLX32 Gateway and click the **DOWNLOAD** button.

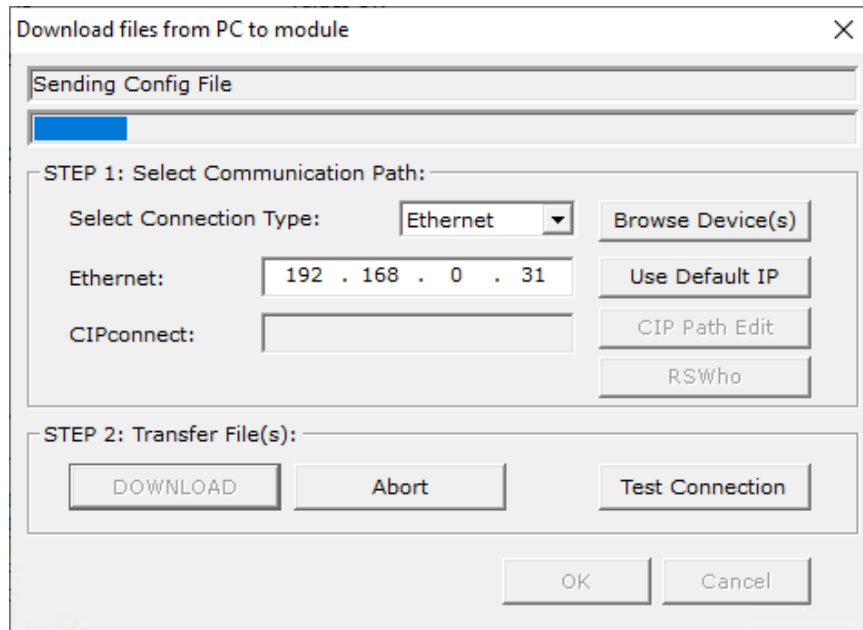

3 IEC-60870-5-104 (104S) Protocol Implementation

This chapter explains how the PLX32 gateway implements the IEC-60870-5-104 protocol, without going into complex details of the specification.

The IEC-60870-5-104 protocol applies to Telecontrol equipment and systems with data transmission for monitoring and controlling geographically widespread processes. This protocol consists of the IEC-60870-5-101 protocol, with the addition of TCP/IP as the transport mechanism.

The IEC-60870-5-104 protocol consists of a client (Controlling Station) and one or more servers (Controlled Stations). The client constantly monitors and controls the data from each server in the TCP/IP network.

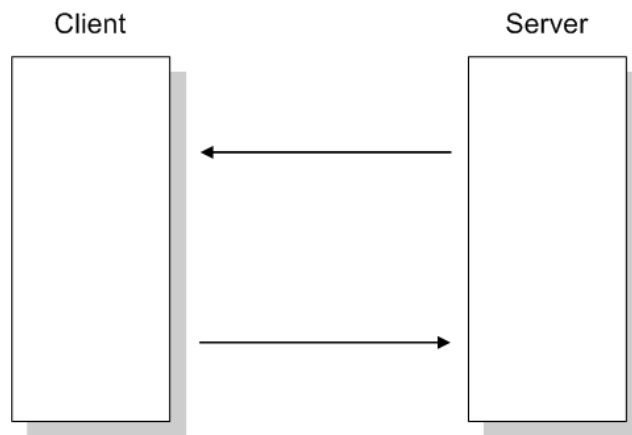

The PLX32 gateway operates as an IEC-60870-5-104 server; it can send monitor data, receive commands, or generate events to the client device.

3.1 IEC 60870-5-104 Server

In PCB, the *104S* section includes all 104S driver configuration parameters.

The following image applies to the PLX32-EIP-104:

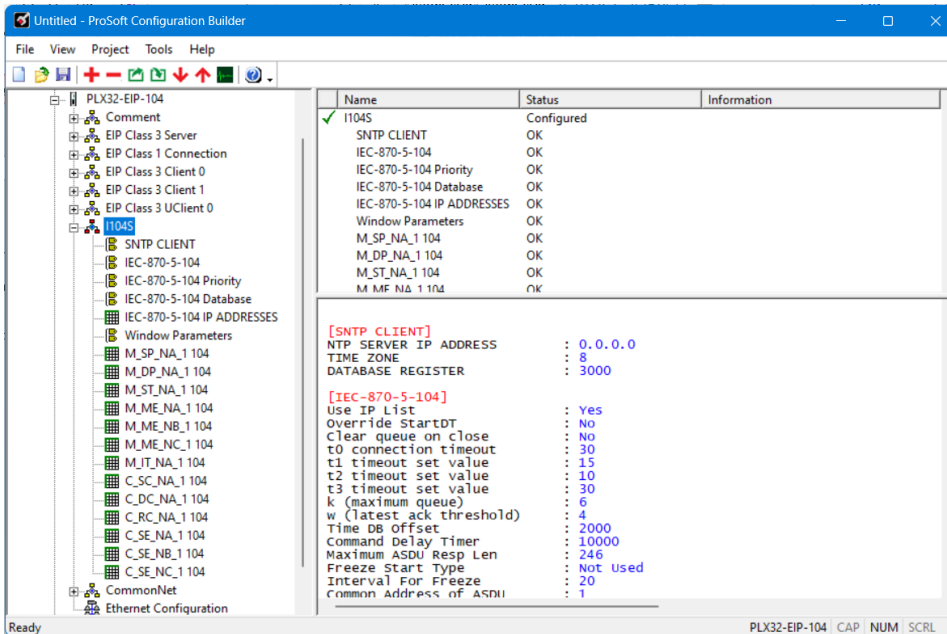

The following image applies to the PLX32-MBTCP-104 v1.005.019 and newer, using PCB v4.8.0.018 and newer:

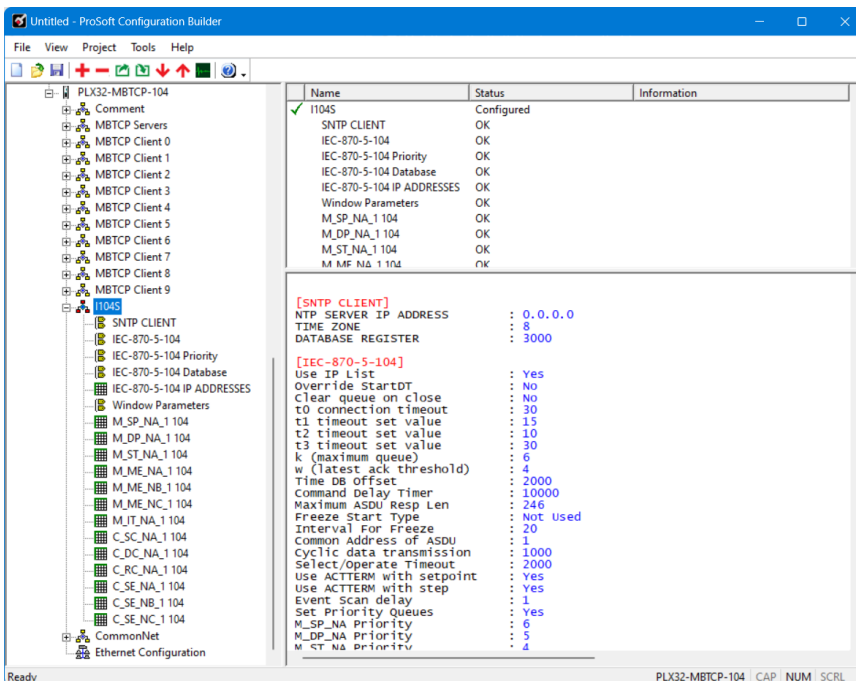

3.1.1 SNTP CLIENT

The *SNTP CLIENT* section is used to specify the parameters for the Simple Network Time Protocol (SNTP) client provided with the protocol driver. This client is required in order to keep the driver's internal clock set correctly. This version of the driver supports SNTP Revision 3 and stratum between 1 and 14.

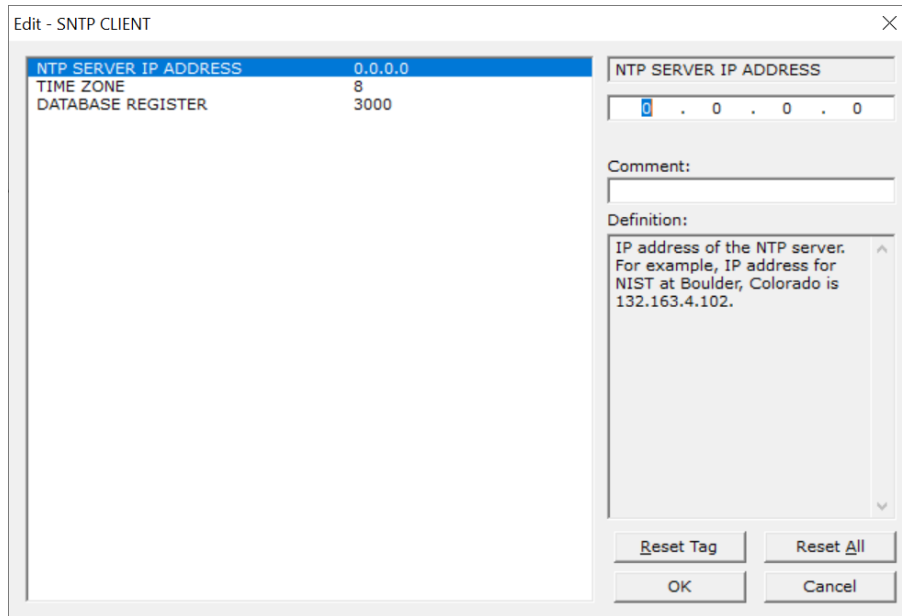
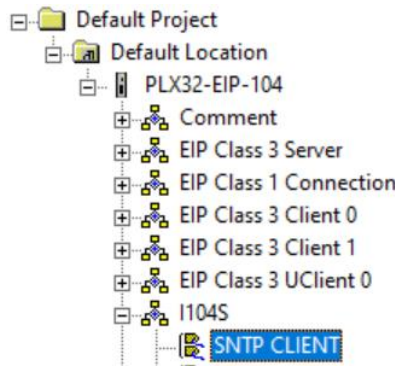

The SNTP driver will compute a new clock value every 5 minutes using the average value of 10 samples each collected over an approximate 6-second period. This new value will be used to adjust the clock maintained by the SNTP driver and used by the application. If a valid database register is specified, the driver will place the time value into the module's database. The first two registers will contain the number of seconds and the next two registers will contain the number of microseconds since January 1, 1970.

A list of some of the common NTP servers can be obtained at:

- <http://www.ntp.org/> or
- <http://support.ntp.org/bin/view/Servers/WebHome>

Other server lists can be found by searching the World Wide Web for "NTP Servers".

Parameter	Range	Description
NTP Server IP Address	xxx.xxx.xxx.xxx	This parameter sets the IP address of the NTP server to utilize for time acquisition. Select an NTP server with the greatest accuracy that can be accessed all the time from your network. Setting this IP address to 0.0.0.0 disables SNTP server requests.
Time Zone	-11 to 11	This parameter specifies the time zone offset to be used from the UTC time zone. A value of zero uses UTC time. If the value entered is positive, the time zone is west of the UTC time zone (that is, Eastern Standard Time is 5). If the value entered is negative, the time zone is east of the UTC time zone (that is, Continental Europe is -1).
Database Register	-1 or 0 to 3992 as an even value	This parameter specifies if the NTP time computed by the driver is to be placed into the module's database. If a value of -1 is specified, the time will not be placed into the database. If the value is between 0 and 3992, the time will be placed in the database. The first 4 bytes will represent the seconds since 1/1/1970, and the second 4 bytes will represent the number of microseconds. An even value should be used for the register value for the data to be stored correctly.

3.1.2 IEC-870-5-104

This section provides information required to configure a server application with the gateway.

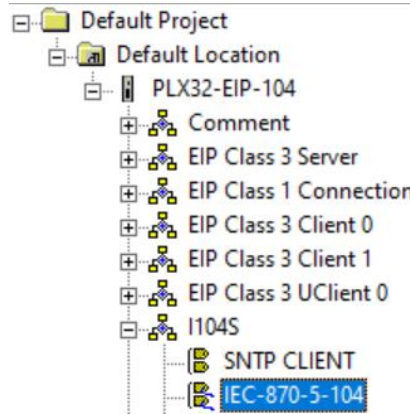

The following image applies to the PLX32-EIP-104:

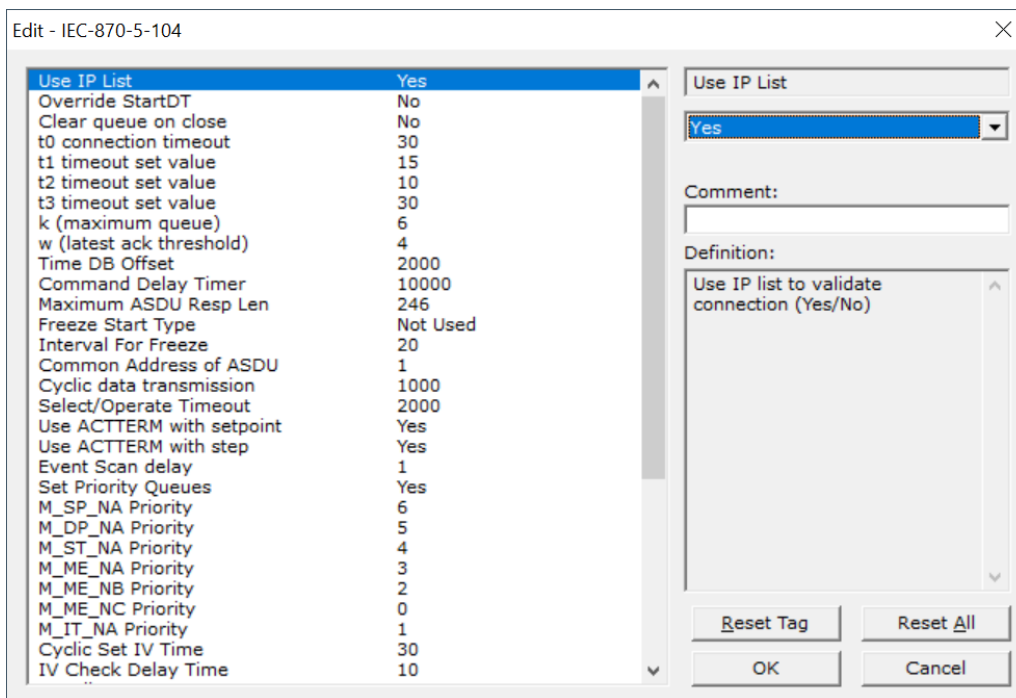

The following image applies to the PLX32-MBTCP-104 v1.005.019 and newer, using PCB v4.8.0.018 and newer:

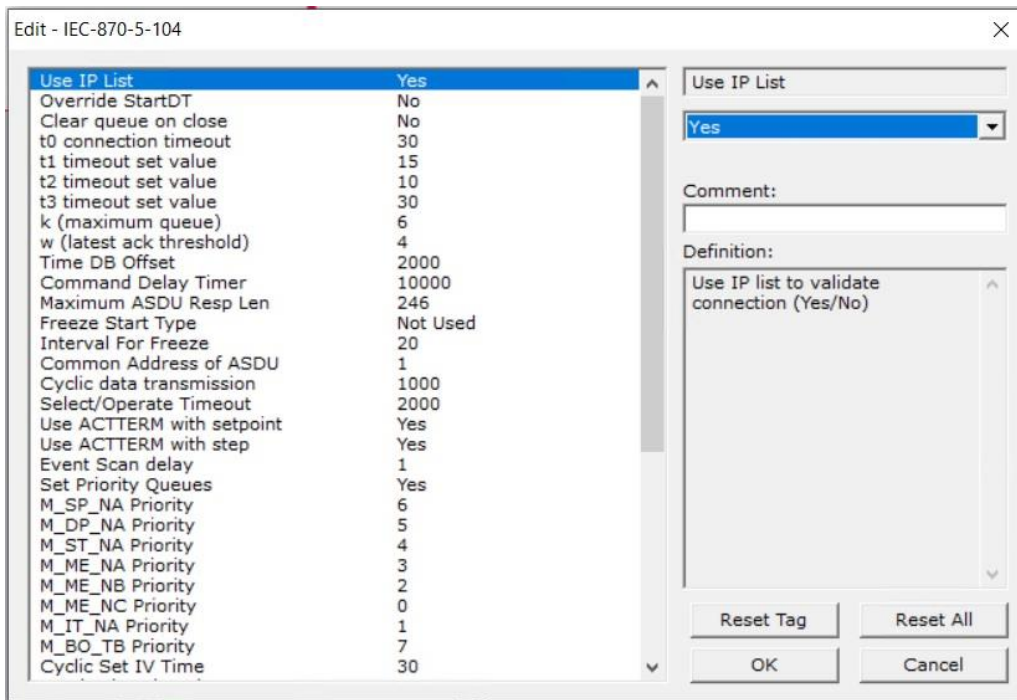

Parameter	Range	Description
Use IP List	NO (0) or YES (1)	This parameter specifies if the IP address of the host connected to the system will be validated. If the parameter is set to NO (0), any host may connect to the unit. If the parameter is set to YES (1), only hosts in the IP list will be permitted to connect to the unit. The IP List refers to the <i>IEC-870-5-104 IP ADDRESSES</i>] menu item. See page 36.
Override StartDT	NO (0) or YES (1)	This parameter is used when testing the gateway with a simulator or with a Client unit that does not meet the IEC 60870-5-104 specification. After the Client connects to the gateway, it will send a STARTDT.ACT U-format message to the gateway to permit the gateway to start sending data. If the Client does not support this requirement, set the parameter to YES (1). Set the parameter to NO (0) if the Client sends the STARTDT.ACT message. Note: This parameter must be set to NO (0) if you wish to use the redundant Clients feature.
Clear Queue on Close	NO (0) or YES (1)	Use this command to define whether the gateway will store the unacknowledged buffers in the unit after the connection is closed. If the specification is to be followed, set this parameter to NO (0) and the packets will be resent after a connection is made. If you want to flush the packets after the connection is closed, set this parameter to YES (1) (this is not according to the IEC 60870-5- 104 specification).

Parameter	Range	Description																																												
t0 timeout set value	1 to 1000	Connection timeout, in seconds																																												
t1 Timeout Set Value	1 to 255	This is the timeout of send or test ASDUs and is in units of seconds. After a packet is sent from the unit, the client must acknowledge the packet within this time interval or else the unit will close the connection.																																												
t2 Timeout Set Value	1 to 255	This is a timeout of when to send an S-format message to the host to acknowledge outstanding messages received. This parameter is in units of seconds and must be less than the value set for t1.																																												
t3 Timeout Set Value	1 to 255	This is the timeout to wait on an idle line before the unit will send a TestFr.Act message. This value is in units of seconds.																																												
k (maximum queue)	1 to 20	This parameter specifies the number of unacknowledged messages the unit will buffer. This parameter must match that in the host. If the set number of buffers are filled in the unit, no other messages will be sent until the host unit acknowledges some or all the messages.																																												
w (latest ack threshold)	1 to 20	This parameter must match that of the host unit and specifies the number of messages the gateway will receive before sending an S-format sequence acknowledge message when no I-format data is ready to send. It is recommended to set this value to 2/3 the value of k.																																												
Time DB Offset	-1, or 0 to 9994	This parameter assigns the database location of the gateway's current date and time. Note: The following table lists the 12-byte data area placed in the database if the Time DB Offset parameter is set to a value other than -1.																																												
<table border="1"> <thead> <tr> <th>Byte</th> <th>Length</th> <th>Range</th> <th>Description</th> </tr> </thead> <tbody> <tr> <td>0 to 1</td> <td>2</td> <td>0 to 59,999</td> <td>Seconds and Milliseconds</td> </tr> <tr> <td>2</td> <td>1</td> <td>0 to 59</td> <td>Minutes</td> </tr> <tr> <td>3</td> <td>1</td> <td>0 to 23</td> <td>Hour</td> </tr> <tr> <td>4</td> <td>1</td> <td>-</td> <td>Reserved</td> </tr> <tr> <td>5</td> <td>1</td> <td>1 to 31</td> <td>Day of the Month</td> </tr> <tr> <td>6</td> <td>1</td> <td>1 to 12</td> <td>Month</td> </tr> <tr> <td>7</td> <td>1</td> <td>-</td> <td>Reserved</td> </tr> <tr> <td>8 to 9</td> <td>2</td> <td>0 to 65535</td> <td>Year</td> </tr> <tr> <td>10</td> <td>1</td> <td>-</td> <td>Reserved</td> </tr> <tr> <td>11</td> <td>1</td> <td>-</td> <td>Reserved</td> </tr> </tbody> </table>			Byte	Length	Range	Description	0 to 1	2	0 to 59,999	Seconds and Milliseconds	2	1	0 to 59	Minutes	3	1	0 to 23	Hour	4	1	-	Reserved	5	1	1 to 31	Day of the Month	6	1	1 to 12	Month	7	1	-	Reserved	8 to 9	2	0 to 65535	Year	10	1	-	Reserved	11	1	-	Reserved
Byte	Length	Range	Description																																											
0 to 1	2	0 to 59,999	Seconds and Milliseconds																																											
2	1	0 to 59	Minutes																																											
3	1	0 to 23	Hour																																											
4	1	-	Reserved																																											
5	1	1 to 31	Day of the Month																																											
6	1	1 to 12	Month																																											
7	1	-	Reserved																																											
8 to 9	2	0 to 65535	Year																																											
10	1	-	Reserved																																											
11	1	-	Reserved																																											
Command Delay Timer	1000 to 60000 milliseconds	This value is used for time-tag validity verification for the ASDUs listed below. The received commands will only be accepted if [timestamp + Command Delay Timer] is greater than the gateway's own time. 58: Single command with time tag CP56Time 2a 59: Double command with time tag CP56Time 2a 60: Regulating step command with time tag CP56Time 2a 61: SetPoint command, normalized value with time tag CP56Time 2a																																												

Parameter	Range	Description
		62: SetPoint command, scaled value with time tag CP56Time 2a 63: SetPoint command, short floating point with time tag CP56Time 2a 107: Test command with time tag CP56Time2a If the value is less than 1000 milliseconds, the gateway will default to 5000 milliseconds.
Maximum ASDU Resp Len	25 to 246	This parameter limits the maximum size of the ASDU portion of a response message. Most applications will use a value of 246.
Freeze Start Type	D, H, M, N	The Freeze Start Type parameter defines when the gateway starts sending the M_IT messages. D = Day H = Hour M = Minute N = Not used
Interval for Freeze	0 to 65535	Freeze Start Type and Interval for Freeze are used if Mode A operation is to be used for the counter freeze operation. If they are not used, the gateway will operate in Mode D.
Common Address of ASDU	0 to 65535	This parameter specifies the common address of the ASDU (section address) for access to data in the gateway. There is only one value entered for access to all data in the gateway.
Cyclic Data Transmission	0 to 4,294,967,296 (2 ³²)	This parameter defines the number of milliseconds between cyclic updates. The range of values for this parameter permit update times of 1 millisecond to 5 minutes. If the parameter is set to 0, cyclic data reporting will be disabled.
Select/Operate Timeout	0 to 4,294,967,296 (2 ³²)	This parameter sets the number of milliseconds after a select command is received in which to wait for a valid execute command. The range of values for this parameter permit times of 1 millisecond to 30 seconds. If the parameter is set to 0, the feature will be disabled.
Use ACTTERM with Setpoint	1 or 0	This parameter determines if an ACTTERM will be sent. If the parameter is set to 1, then setpoint commands will issue an ACTTERM when the command is complete. If the parameter is set to 0, ACTCON is the last response to a setpoint command.
Use ACTTERM with Step	1 or 0	This parameter determines if an ACTTERM will be sent. If the parameter is set to 1, then step commands will issue an ACTTERM when the command is complete. If the parameter is set to 0, ACTCON is the last response to a step command.
Event Scan Delay	1 to 65535, or 0 to disable	If set to 0, the feature will be disabled and the gateway will not generate any events. If set from 1 to 65535, the parameter represents the number of milliseconds between event scanning. This parameter defines how often the program will scan for new events in the databases.

Parameter	Range	Description
Set Priority Queues	YES or NO	This section defines priority queues for the gateway. You can assign priorities to data types that can return events so that events of M_xxx data types will be returned before other data types. This may cause events to be lost as the event buffers for low priority queues may overflow. If this feature is utilized, each data type must be assigned a unique index from 0 to 6 (for PLX32-EIP-104) and 0 to 7 (for PLX32-MBTCP-104). The lower the index, the higher the priority (0=highest priority).

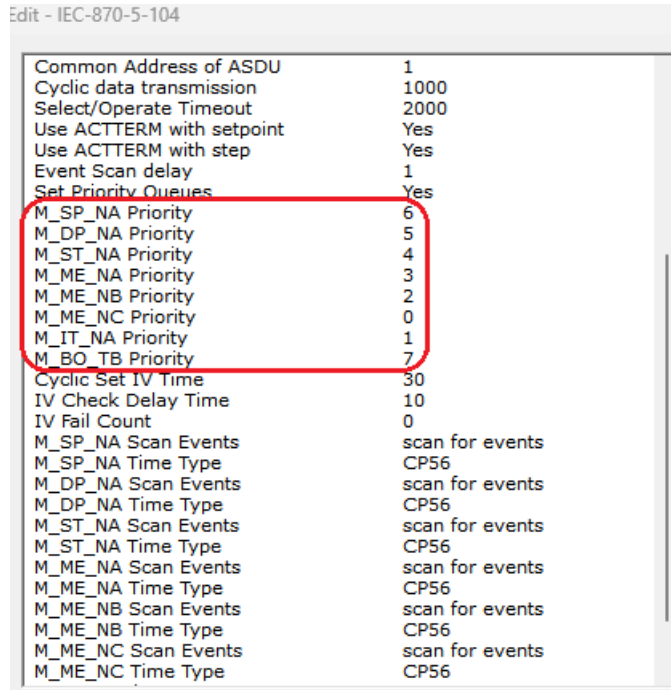

Note: The *M_BO_TB Priority* datatype applies only to the PLX32-MBTCP-104 v1.005.019 and newer, using PCB v4.8.0.018 and newer.

Each of the ASDUs affected by this feature must be assigned a unique priority index from 0 to 6 (for PLX32-EIP-104) and 0 to 7 (for PLX32-MBTCP-104). Events of the ASDU with a priority of 0 will always be reported before any others when they are present.

For more information, refer to Event Priority (page 81).

M_SP_NA Priority	0 to 6 (PLX32-EIP-104)	Priority number for M_SP_NA points
M_DP_NA Priority	0 to 7 (PLX32-MBTCP-104)	Priority number for M_DP_NA points

Parameter	Range	Description
	0 to 7 (PLX32-MBTCP-104)	
M_ST_NA Priority	0 to 6 (PLX32-EIP-104)	Priority number for M_ST_NA points
	0 to 7 (PLX32-MBTCP-104)	
M_ME_NA Priority	0 to 6 (PLX32-EIP-104)	Priority number for M_ME_NA points
	0 to 7 (PLX32-MBTCP-104)	
M_ME_NB Priority	0 to 6 (PLX32-EIP-104)	Priority number for M_ME_NB points
	0 to 7 (PLX32-MBTCP-104)	
M_ME_NC Priority	0 to 6 (PLX32-EIP-104)	Priority number for M_ME_NC points
	0 to 7 (PLX32-MBTCP-104)	
M_IT_NA Priority	0 to 6 (PLX32-EIP-104)	Priority number for M_IT_NA points
	0 to 7 (PLX32-MBTCP-104)	
M_BO_TB Priority	0 to 7 (PLX32-MBTCP-104 only)	Priority number for M_BO_TB points. Note: This parameter applies to the PLX32-MBTCP-104 v1.005.019 and newer, using PCB v4.8.0.018 and newer.
Cyclic Set IV Time	1 to 65535 seconds, or 0 to disable Invalid Bit Monitoring	The parameter should be set to a value significantly greater than the value of the <i>IV Check Delay Time</i> parameter, multiplied by the value of the <i>IV Fail Count</i> parameter. For more information on invalid bit monitoring, please see page 83.
IV Check Delay Time	1 to 65535 seconds, or 0 to disable Invalid Bit Monitoring	This parameter sets the number of seconds between IV Bit value checks. Every IEC database monitor point which has an IV Bit address set greater than 0 will have that bit address checked at the interval specified by this parameter. Setting this parameter to zero (0) will disable data validity checking. For more information on invalid bit monitoring, please see page 83.

Parameter	Range	Description
IV Fail Count	1 to 65535 seconds, or 0 to disable Invalid Bit Monitoring	<p>This parameter sets the number of successive IV Bit check failures which must occur before the data from a IEC database monitor point will be reported to the remote Client as invalid data.</p> <p>An IV Bit Check Failure occurs when the IV Bit value in the gateway database is set ON, when it contains a value of one (1), at the time an IV Bit Check is performed. IV Bit Check failures are counted and held in separate IV Bit Check Failure accumulators for each IEC monitor point configured for validity checking. If the value in any point's failure accumulator becomes equal to the value set in this parameter, the gateway will flag the data from this point as invalid and report to the Client this invalid status, along with the point's data value. Setting this parameter to zero (0) will disable data validity checking.</p> <p>For more information on invalid bit monitoring, please see page 83.</p>
Scan Events	0 = NO SCANNING 1 = SCAN FOR EVENTS	<p>Separate parameters exist for multiple point types. Example: <i>M_SP_NA Scan Events</i></p> <p>Defines whether events of this point type will be generated by the gateway. If "No Scanning", then events will not be generated. If "Scan for events", events will be scanned and generated on change.</p>
Time Type	0 = NONE 1 = CP24 2 = CP56	<p>Separate parameters exist for multiple point types. This parameter defines the time format used with data events. Example: <i>M_SP_NA Time Type</i></p>

3.1.3 IEC-870-5-104 Priority

This feature provides priority queues by the originator, allowing for certain messages to be processed as a higher priority than others.

The queues have a fixed priority in relation to each other. The *Priority 0* queue is the highest priority followed by *Priority 1* and *Priority 2*. Each queue is tied to a specific originator. The originator address is tied to the specific queue in the configuration of *Priority 0*, *Priority 1*, and *Priority 2*.

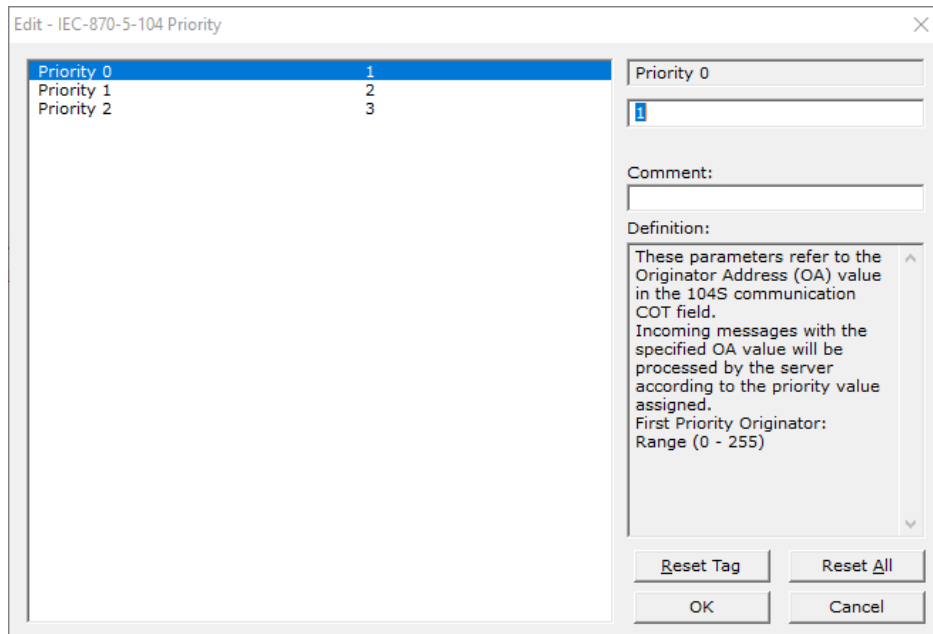
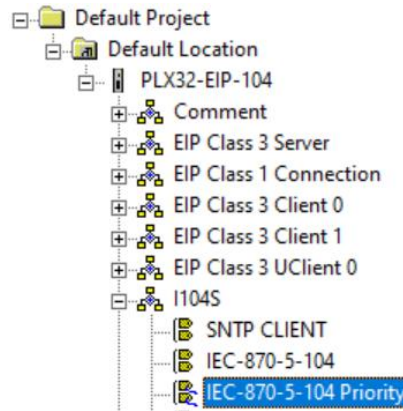

Parameter	Range	Description
Priority 0	0 to 255	First priority originator. These parameters refer to the Originator Address (OA) value in the 104S communication COT field. Incoming messages with the specified OA value will be processed by the server according to the priority value assigned.
Priority 1	0 to 255	Second priority originator. These parameters refer to the Originator Address (OA) value in the 104S communication COT field. Incoming messages with the specified OA value will be processed by the server according to the priority value assigned.
Priority 2	0 to 255	Third priority originator. These parameters refer to the Originator Address (OA) value in the 104S communication COT field. Incoming messages with the specified OA value will be processed by the server according to the priority value assigned.

When a message is received, it is checked for an originator matching one of the queues. Once matched, the message will be placed in the appropriate queue. Messages from the highest priority queue are processed first, then the messages in the queue of next priority.

Each time a message is fetched, it will check for the highest priority message in the queues at that time. Each queue has a limit of 20 messages at any given time.

If there is only one incoming message, it will be processed immediately after being placed in the queue.

Messages with no originator or an originator not matching a queue will be processed as they are received.

3.1.4 IEC-870-5-104 Database

This section describes parameters in the *IEC-870-5-104 Database* section.

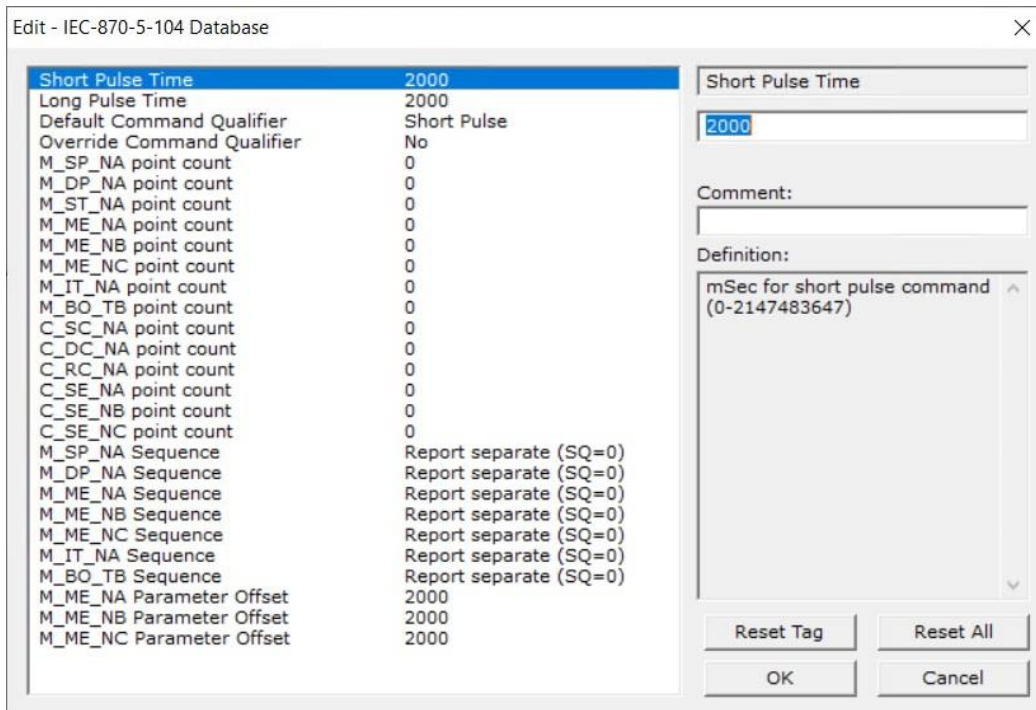
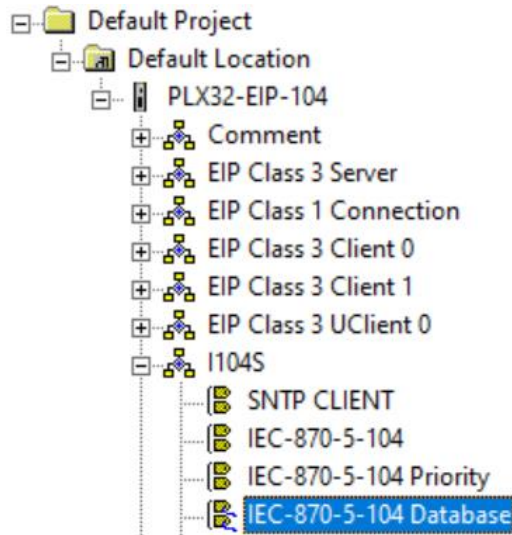

Parameter	Range	Description
Short Pulse Time	0 to 2,147,483,647 (2 raised to the power of 31) milliseconds	This parameter defines the number of milliseconds to keep an IEC Command Point set ON, HIGH, equal to one (1), before returning the point to OFF, LOW, equal to zero (0), whenever a pulse point command is sent by the Client and the default value of the Default Command Qualifier parameter is set to SHORT.
Long Pulse Time	0 to 2,147,483,647 (2 raised to the power of 31) milliseconds	This parameter defines the number of milliseconds to keep an IEC Command Point set ON, HIGH, equal to one (1), before returning the point to OFF, LOW, equal to zero (0), whenever a pulse point command is sent by the Client and the default value of the Default Command Qualifier parameter is set to LONG.
Default Command Qualifier	S, L, P	S = Short pulse L = Long pulse P = Persistent output
Override Command Qualifier	No, S, L, P	No = Will not cause override S = Always use Short pulse L = Always use Long pulse P = Always use Persistent
Point Count		Point Count configuration ranges in the following configuration items assume that you will be using only one of the available data types for your application. The number of point counts you configure will have an effect on gateway performance, in particular the accuracy of the gateway's internal clock.

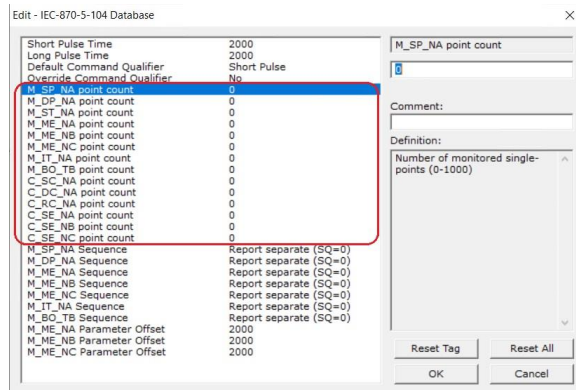

Note: The *M_BO_TB point count* parameter applies only to the PLX32-MBTCP-104 v1.005.019 and newer, using PCB v4.8.0.018 and newer.

Sequence Flag YES or NO

To save bandwidth, you can configure the gateway to use the Sequence Flag feature using these parameters.

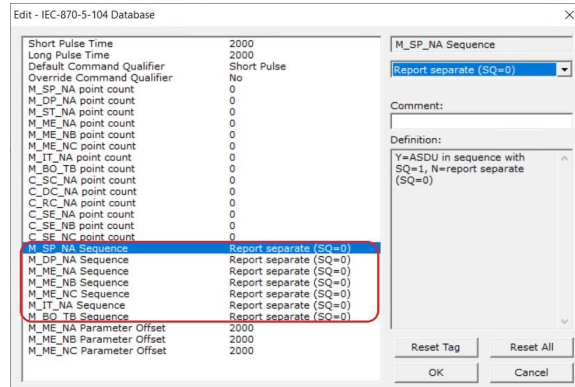

Note: The *M_BO_TB Sequence* parameter applies only to the PLX32-MBTCP-104 v1.005.019 and newer, using PCB v4.8.0.018 and newer.

If this parameter is set to NO, this feature is not selected, the gateway will send the object address and value for every monitored point sent to the Client, and the Sequence Flag (SQ) will be set to zero (0). If this parameter is set to YES, this feature is selected, the gateway will send the object point address and value for only the first point of a sequence of points, send only the data value without point address for any remaining points in the sequence, and the Sequence Flag (SQ) will be set to one (1). When SQ = 1, the Client assumes that all points after the first point use information object addresses in a contiguous order (using the first point as the reference starting address).

Note: Refer to the client device specification to verify if this feature is supported before you consider using it.

Parameter Offset 0 to 9999

This parameter specifies the Information Object Address (IOA) Offset to normalized points parameter data. The entered value is added to the IOA for the associated point to compute the IOA address. The Client may send a "Parameter of Measured Normalized" or "Parameter of Measured Scaled" command using the parameter IOA to change the threshold deadband values for specific points. For example, if the PLX32 gateway configuration sets two M_ME_NA points with IOA (Point #) of 600 and 601 and a M_ME_NA Parameter Offset value of 2000, the threshold deadband parameters for those points would be written to IOA addresses 2600 and 2601.

Note: The Low Limit and High Limit threshold values are calculated based on the Threshold deadband value.

Threshold: Determined by the deadband set in the configuration file or altered by the write command.

Low Limit: Last reported event value - threshold.

High Limit: Last reported event value + threshold.

Point Count

Point Count	Range	Description
M_SP_NA	0 to 1000	Specifies the number of point values assigned for the monitored single-point database.
M_DP_NA	0 to 1000	Specifies the number of point values assigned for the monitored dual-point database.
M_ST_NA	0 to 1000	Specifies the number of point values assigned for the monitored step-point database.
M_ME_NA	0 to 1000	Specifies the number of point values assigned for the monitored normalized-point database.
M_ME_NB	0 to 1000	Specifies the number of point values assigned for the monitored scaled-point database.
M_ME_NC	0 to 1000	Specifies the number of point values assigned for the monitored scaled short-float point database.
M_IT_NA	0 to 99	Specifies the number of point values assigned for the monitored counter-point database.
M_BO_TB	0 to 100	Specifies the number of point values assigned for the monitored 32-bit string point database. Note: This Point Count applies only to the PLX32-MBTCP-104 v1.005.019 and newer, using PCB v4.8.0.018 and newer.
C_SC_NA	0 to 1000	Specifies the number of point values assigned for the command single-point database.
C_DC_NA	0 to 1000	Specifies the number of point values assigned for the command dual-point database.
C_RC_NA	0 to 1000	Specifies the number of point values assigned for the command step-point database.
C_SE_NA	0 to 1000	Specifies the number of point values assigned for the command normalized-point database.
C_SE_NB	0 to 1000	Specifies the number of point values assigned for the command scaled-point database.
C_SE_NC	0 to 50	Specifies the number of point values assigned for the command short-float point database.

3.1.5 IEC-870-5-104 IP Addresses

This section enters the IP addresses for the hosts to connect to this unit. The unit will only accept connections from hosts listed here. This list may contain up to 10 entries between the START and END labels. The address must start in column 1, and must be entered in standard dot notation.

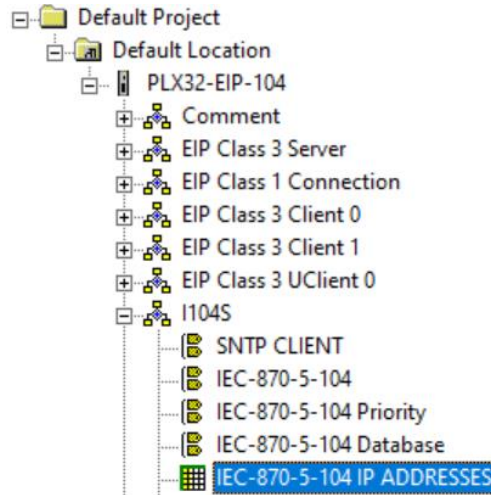

Click the **ADD ROW** button to enter the host IP address.

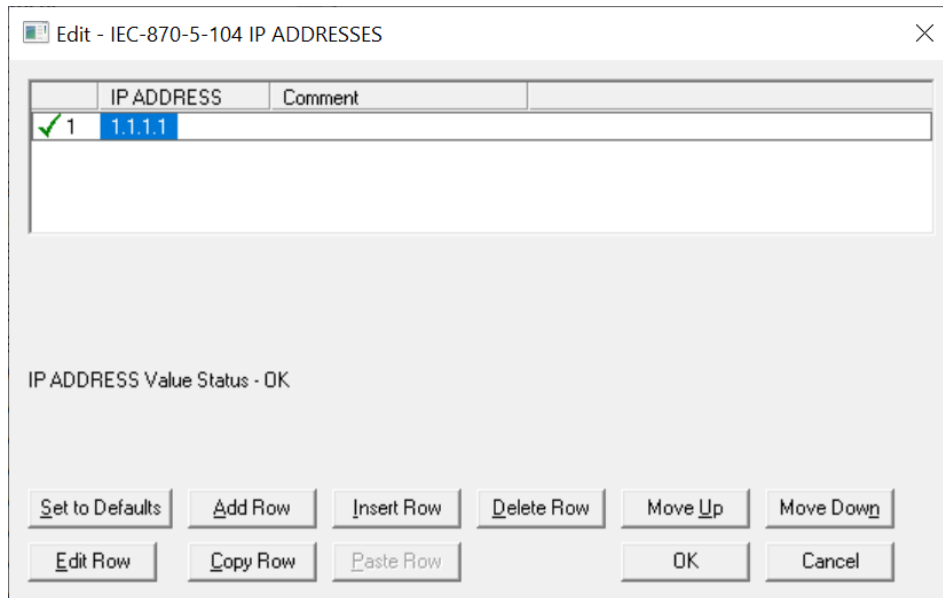

3.1.6 Window Parameters

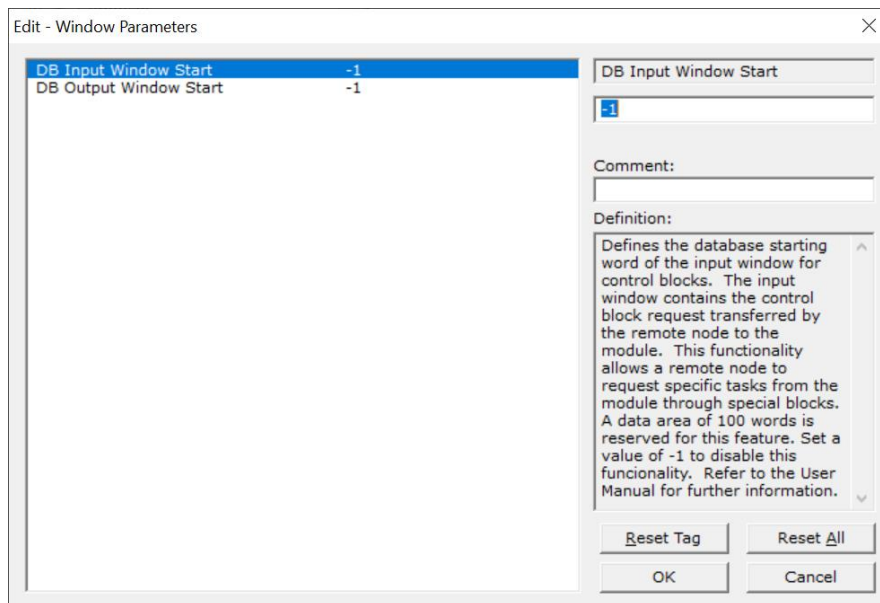
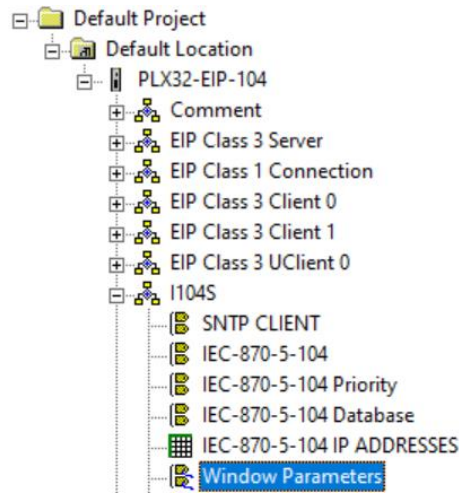

Parameter	Range	Description
DB Input Window Start	-1, or 0 to 9799	Defines the database starting word of the input window for control blocks. The input window contains the control block request transferred by the remote node to the module. This functionality allows a remote node to request specific tasks from the module through special blocks. A data area of 100 words is reserved for this feature. Set a value of -1 to disable this functionality.
DB Output Window Start	-1, or 0 to 9899	Defines the database starting word of the output window for control blocks. The output window contains the control block response set by the module and to be read by the remote node. This functionality allows a remote node to request specific tasks from the module through special blocks. A data area of 100 words is reserved for this feature. Set a value of -1 to disable this functionality.

3.1.7 Point List

This section allows the user to generate the points according to each ASDU type:

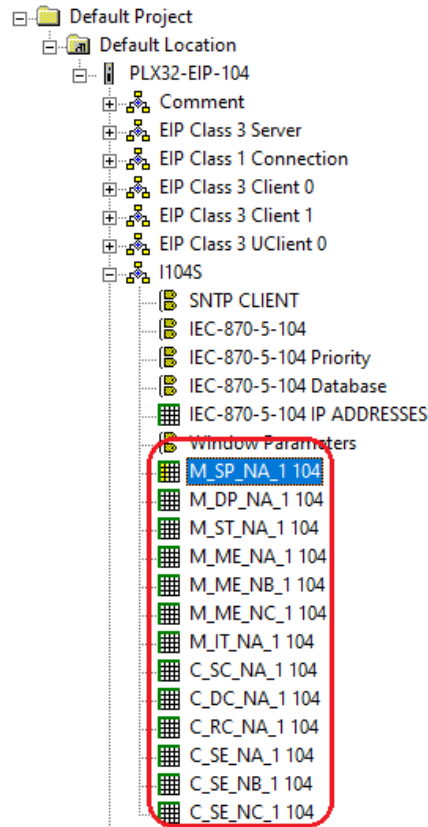

Parameter	Range	Description
M_SP_NA_1 104	1 = Bit On 0 = Bit Off	This defines the monitored single-point database for the server device emulated. This information is sourced from the database and is transferred to the remote client unit. Each point is one bit and the DB address value corresponds to the bit offset in the gateway memory database.
M_DP_NA_1 104	00 = Intermediate 01 = Point Off 10 = Point On 11 = Intermediate	This defines the monitored dual-point database for the server device emulated. This information is sourced from the database and is transferred to the remote client unit. Each point is two bits and the DB address value corresponds to the bit offset in the gateway memory database.
M_ST_NA_1 104		This defines the monitored step database for the server device emulated. This information is sourced from the database and is transferred to the remote client unit. Each point is one, 8-bit byte and the DB Address value corresponds to the byte offset in the gateway memory database.
M_ME_NA_1 104		This defines the monitored measured value, normalized database for the server device emulated. This information is sourced from the database and is transferred to the remote client unit.

Parameter	Range	Description
		To determine the IOA (Information Object Address) for each object, add the Point # (IOA) in the following section to the value of the M_ME_NA Parameter Offset as entered in the [IEC-870-5-104 Database] section. Each point is one, 16-bit word and the DB Address value corresponds to the word offset in the gateway memory database.
M_ME_NB_1 104		This defines the monitored measured value, scaled database for the server device emulated. This information is sourced from the database and is transferred to the remote client unit. To determine the IOA (Information Object Address) for each object, add the Point # (IOA) to the M_ME_NB Parameter Offset parameter value as entered in the [IEC-870-5-104 Database] section. Each point is one, 16-bit word and the DB Address value corresponds to the word offset in the gateway memory database.
M_ME_NC_1 104		This defines the monitored short-float point database for the slave device emulated. This information is sourced from the database and is transferred to the remote client unit. To determine the IOA (Information Object Address) for each object, add the Point # (IOA) to the M_ME_NC Parameter Offset parameter value as entered in the [IEC-870-5-104 Database] section. Each point is two, 16-bit words and the DB Address value corresponds to the double-word offset in the gateway memory database.
M_IT_NA_1 104		This defines the monitored integrated totals (counter) database for the server emulated. This information is sourced from the database and is transferred to the remote client unit. Each point is two, 16-bit words and the DB Address value corresponds to the double-word offset in the gateway memory database.
M_BO_TB_1 104 (PLX32-MBTCP-104 only)		This defines the monitored 32-bit string database for the server device emulated. This information is sourced from the database and is transferred to the remote client unit. Each point is two, 16-bit words and the DB Address value corresponds to the double word offset in the gateway memory database. Note: This applies only to the PLX32-MBTCP-104 v1.005.019 and newer, using PCB v4.8.0.018 and newer.
C_SC_NA_1 104		This defines the single point command database for the server emulated. This information is sourced from the remote client and is transferred to the database. You can associate a command with a monitored single-point database value to coordinate the command/monitor operation. You must enter the correct Monitor Point # and Monitor DB Address values in the table. If the Require Select parameter is not set to zero, a select command must be received before an execute command will be processed. Each point is one bit and the DB Address value corresponds to the bit offset in the gateway memory database.

Parameter	Range	Description
C_DC_NA_1 104		<p>This defines the double point command database for the server emulated. This information is sourced from the remote client and is transferred to the database. You can associate a command with a monitored double point database value to coordinate the command/monitor operation. You must enter the correct Monitor Point # and Monitor DB Addr values in the table. If the Require Select parameter is not set to zero, a select command must be received before an execute command will be processed.</p> <p>Each point is two bits and the DB Address value corresponds to the bit offset in the gateway memory database.</p>
C_RC_NA_1 104		<p>This defines the step command database for the server emulated. This information is sourced from the remote client and is transferred to the database. The control value can be associated with a monitored point as described in the previous example.</p> <p>Each point is one, 8-bit byte and the DB Address value corresponds to the byte offset in the gateway memory database.</p>
C_SE_NA_1 104		<p>This defines the normalized setpoint database for the server emulated. This information is sourced from the remote client and is transferred to the database. You can associate a command with a monitored normalized database value to coordinate the command/monitor operation. You must enter the correct Monitor Point # and Monitor DB Addr values in the table. If the Require Select parameter is not set to zero, a select command must be received before an execute command will be processed.</p> <p>Each point is one, 16-bit word and the DB Address value corresponds to the word offset in the gateway memory database.</p>
C_SE_NB_1 104		<p>This defines the scaled setpoint database for the server emulated. This information is sourced from the remote client and is transferred to the database. You can associate a command with a monitored scaled database value to coordinate the command/monitor operation. You must enter the correct Monitor Point # and Monitor DB Addr values in the table. If the Require Select parameter is set to one (1) or YES, a Select command must be received from the Client before an execute command from the Client will be processed.</p> <p>Each point is one, 16-bit word and the DB Address value corresponds to the word offset in the gateway memory database.</p>
C_SE_NC_1 104		<p>This defines the short-float setpoint database for the server emulated. This information is sourced from the remote client and is transferred to the database. If the Require Select parameter is set to one (1) or YES, a Select command must be received from the Client before an Execute command from the Client will be processed.</p> <p>Each point is two, 16-bit words and the DB Address value corresponds to the double-word offset in the gateway memory database.</p>

3.2 Monitor Direction and Control Direction: Point Definition

The protocol specification defines two directions of data: monitor direction and control direction.

Monitor Direction: The direction of transmission from a server to a Client

Control Direction: The direction of transmission from a Client to a server

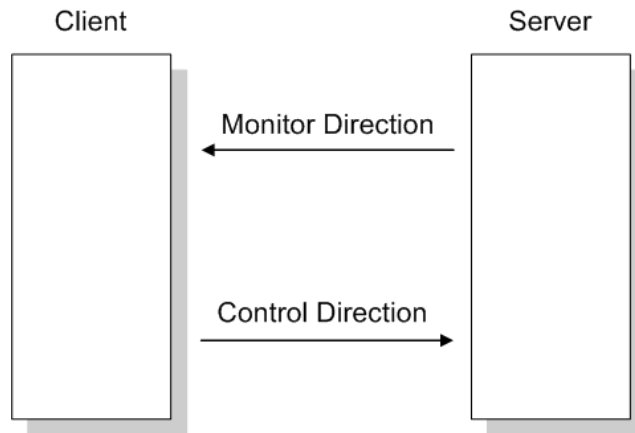

The points that are typically transferred from a server to a Client are also known as **Monitor Points** (or Monitor Information Objects). The points that are typically transferred from a Client to a server are also known as **Control Points** (or Command Information Objects).

The PLX32 gateway contains an internal database of 10,000 16-bit words. You must associate the monitor and control points to database addresses in the PLX32 gateway. To configure the points for the PLX32 gateway, follow these steps:

- 1 Calculate the number of monitor and control points for the application.
- 2 Calculate the PLX32 gateway database regions that are required for the application, based on the number of monitor and control points. Define two separate regions. Remember that each data type stores a different quantity of data (for example, M_SP_NA uses one bit, M_ST_NA uses one byte, and so on).
- 3 Configure each point within its PLX32 gateway database region.

- 4 Make sure that the other parts of your application correctly update gateway memory database regions through the other gateway communication protocol, as shown in the following illustration.

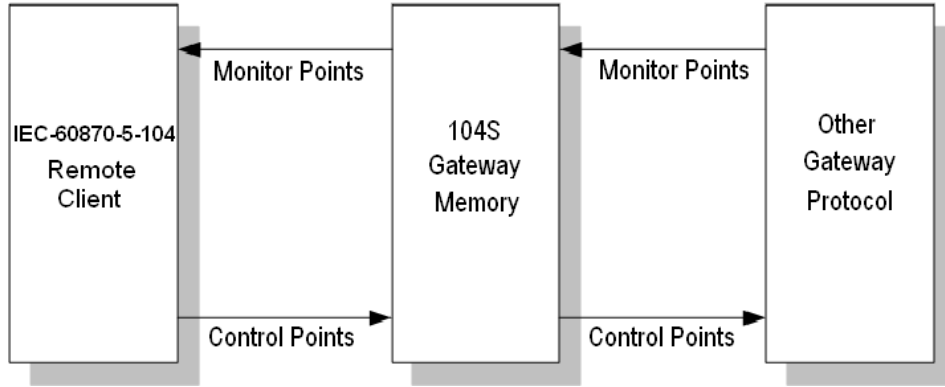

- 5 All points must be configured in the correct location in the PLX32 gateway database in order to be properly updated by the other gateway protocol by configuring the control points and monitor points in separate areas of the PLX32 gateway database. The following illustration shows an example configuration:

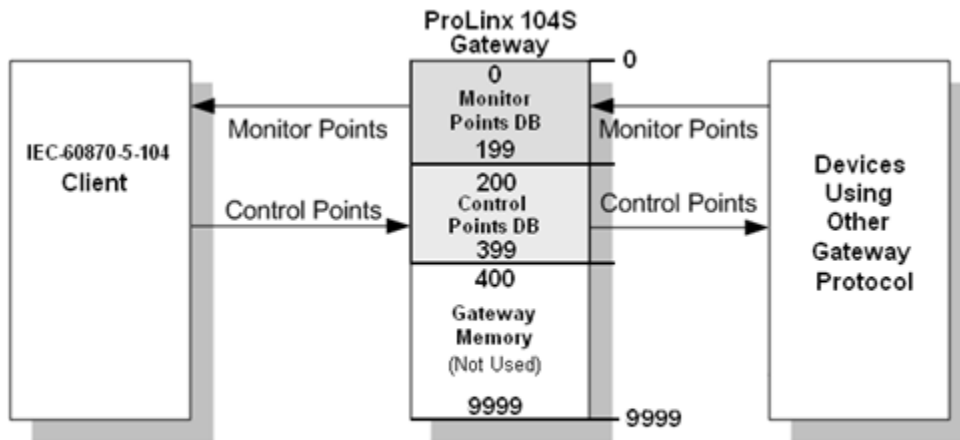

In this example, all monitor points are located between database addresses 0 and 199, and all control points are located between address 200 and 399.

3.3 Using Monitor Points

The following monitor points are supported by the PLX32 gateway:

Symbol	Description	Data Size in Database	Addressing Type
M-SP-NA	Monitored Single-Points	1 bit	Bit
M-DP-NA	Monitored Dual-Points	2 bits	Bit
M-ST-NA	Monitored Step-Points	1 byte	Byte
M-ME-NA	Monitored Measured Normalized-Points	1 word	Word
M-ME-NB	Monitored Measured Scaled-Points	1 word	Word
M-ME-NC	Monitored Measured Short Floating Points	2 words	Double-Word
M-IT-NA	Monitored Counter-Points	2 words	Double-Word
M-BO-TB	Monitored 32-bit String Points. Note: This parameter only applies to the PLX32-MBTCP-104 v1.005.019 and newer, using PCB v4.8.0.018 and newer.	2 words	Double-Word

Each monitor point is identified by its Information Object Address (it should be unique for each Common ASDU Address in the network). For each monitor point, configure the following parameters:

Parameter	Description
Point #	The information object address of the point. It identifies the point in the network.
DB Address	The database location in the PLX32 gateway associated with the point. You must associate each point to a database address in the PLX32 gateway. The interpretation of this parameter depends on the point type configured. For example, for an M_SP_NA point, this value represents the bit address. For a M_ME_NA point, this value represents the Word address.
Group(s)	This is the group definition for the point. It sets how the point will be polled by the master (cyclic or group interrogation). It can also be used to enable or disable the event generation for one specific point. The group parameter is discussed in the Data Communication section.
Deadband	Sets the deadband for each Measured point. If the value changes from more than the configured deadband, the PLX32 gateway generates an event for this point.
IV DB Bit	This feature allows the application to set the invalid (IV) quality bit of the protocol for all the monitored ASDU types supported. If you enable this feature, the other gateway protocol can determine the individual IV quality bit status of each point you configured.

3.3.1 Monitor Data Transfer

Configure the group code for each monitor point to define how the master will poll for the point. The group codes are defined as follows:

Group Code	Description
0x00000001	Interrogated by general interrogation (station or global)
0x00000002	Interrogated by group 1 interrogation
0x00000004	Interrogated by group 2 interrogation
0x00000008	Interrogated by group 3 interrogation
0x00000010	Interrogated by group 4 interrogation
0x00000020	Interrogated by group 5 interrogation
0x00000040	Interrogated by group 6 interrogation
0x00000080	Interrogated by group 7 interrogation
0x00000100	Interrogated by group 8 interrogation
0x00000200	Interrogated by group 9 interrogation
0x00000400	Interrogated by group 10 interrogation
0x00000800	Interrogated by group 11 interrogation
0x00001000	Interrogated by group 12 interrogation
0x00002000	Interrogated by group 13 interrogation
0x00004000	Interrogated by group 14 interrogation
0x00008000	Interrogated by group 15 interrogation
0x00010000	Interrogated by group 16 interrogation
0x00020000	Interrogated by general counter request
0x00040000	Interrogated by group 1 counter request
0x00080000	Interrogated by group 2 counter request
0x00100000	Interrogated by group 3 counter request
0x00200000	Interrogated by group 4 counter request
0x40000000	Disable event scanning of this point
0x80000000	Periodic/cyclic data returned from unit

The gateway will periodically send all points configured for periodic/cyclic poll (0x80000000) at every x milliseconds, where x is configured with the following parameter:

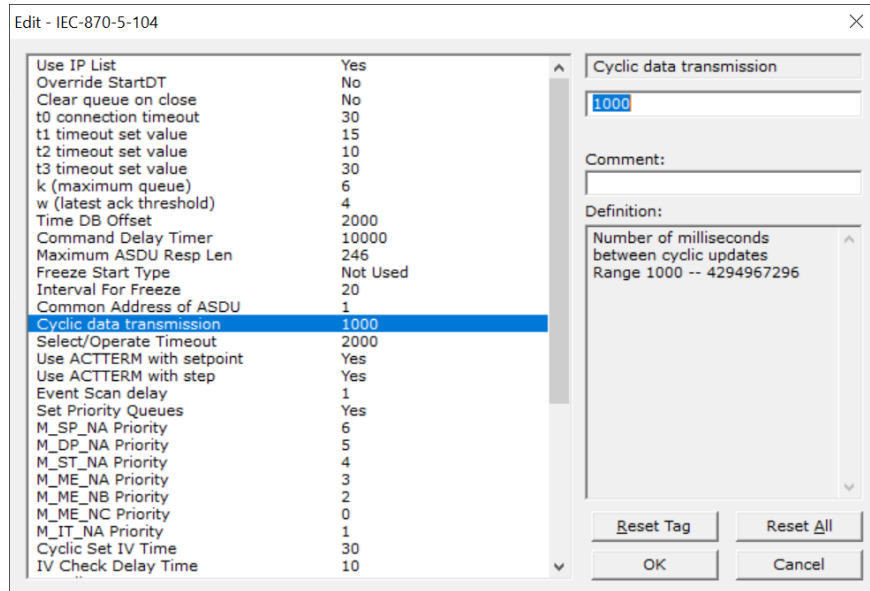

Example - Periodic Monitor Polling:

If the following point is configured for monitor polling:

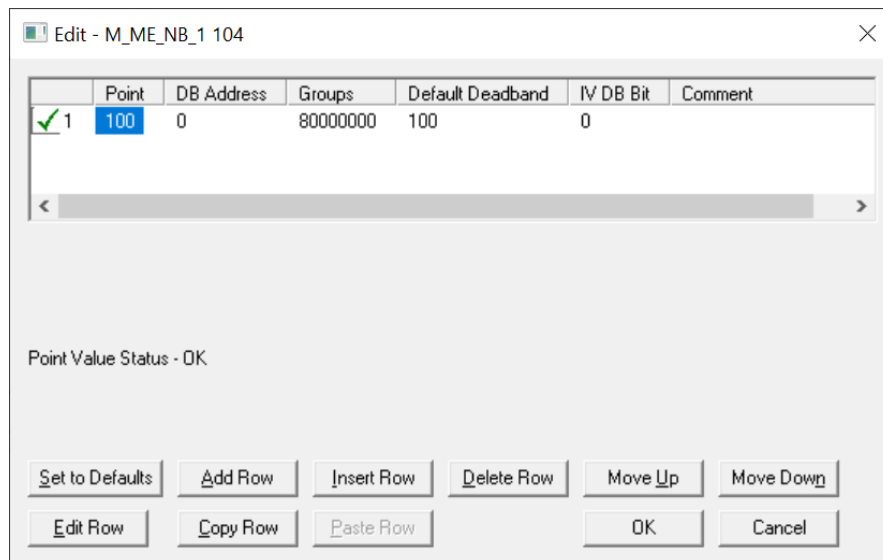

If you configure the periodic polling for 10 seconds (10000 milliseconds) as follows:

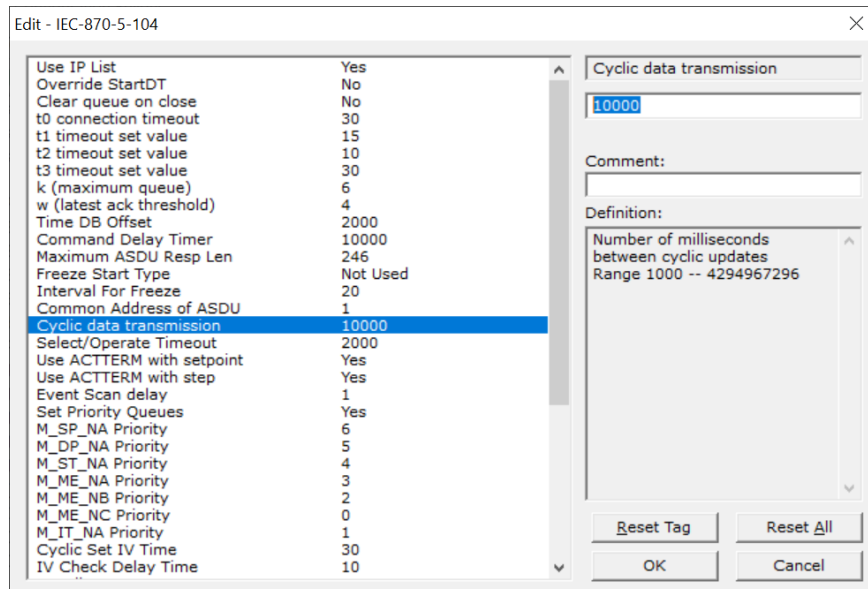

The following illustration shows the communication procedure:

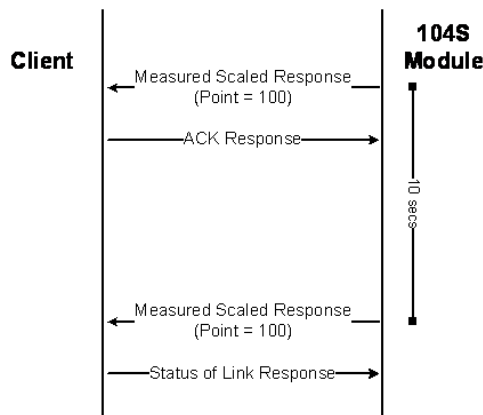

Therefore, the point configured for a cyclic poll is periodically reported to the master. You may also create groups of points allowing the master to poll certain points more frequently than other points. The master may send requests for different groups as follows:

- General Interrogation (station)
- General Interrogation for Group 1
- General Interrogation for Group 2
- (...)
- General Interrogation for Group 16

Example - General Interrogation

The following points are configured for General Interrogation.

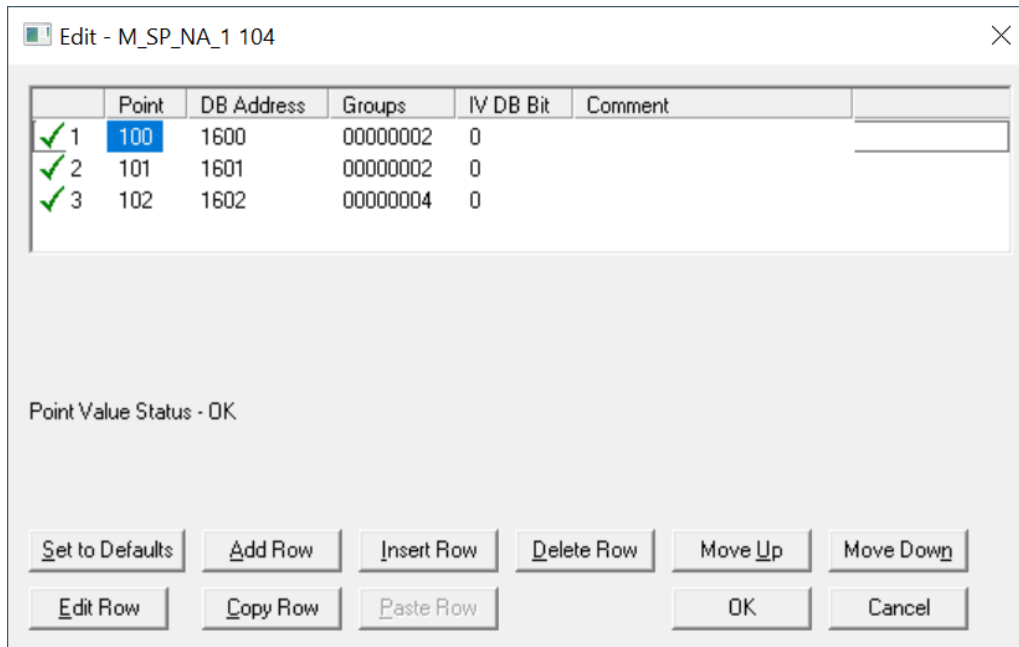

This feature allows you to separate the points into different groups according to the priority level that these should be reported to the master. In the example above, points 100 and 101 would be returned with a General Interrogation for Group 1 and point 102 would be returned with a General Interrogation for Group 2.

Counter Points

There are four modes of acquisition of integrated totals (M_IT_NA points) defined by the protocol specification. The actual values may be memorized (copied) periodically to frozen values by a freeze command received from the master or initiated locally within the gateway.



The gateway supports the following modes:

Mode A - Local freeze with spontaneous transmission

Mode D - Counter interrogation commands from the master initiate the freeze operation and the frozen values are reported spontaneously.

Example - Mode A

To use Mode A, configure the following parameters:

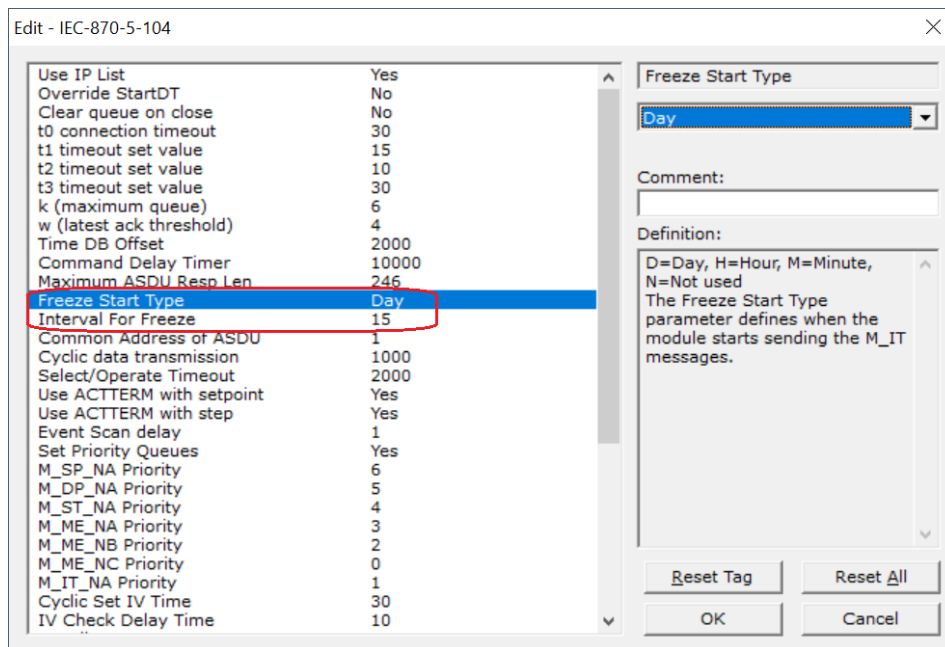

Freeze Start Type

The Freeze Start Type parameter will define when the gateway starts sending the M_IT messages.

Example I - Freeze Start Type

If the gateway powers up with the following date and time clock: 03/25/2004 18:07:42

If you configure the *Interval For Freeze* parameter as follows:

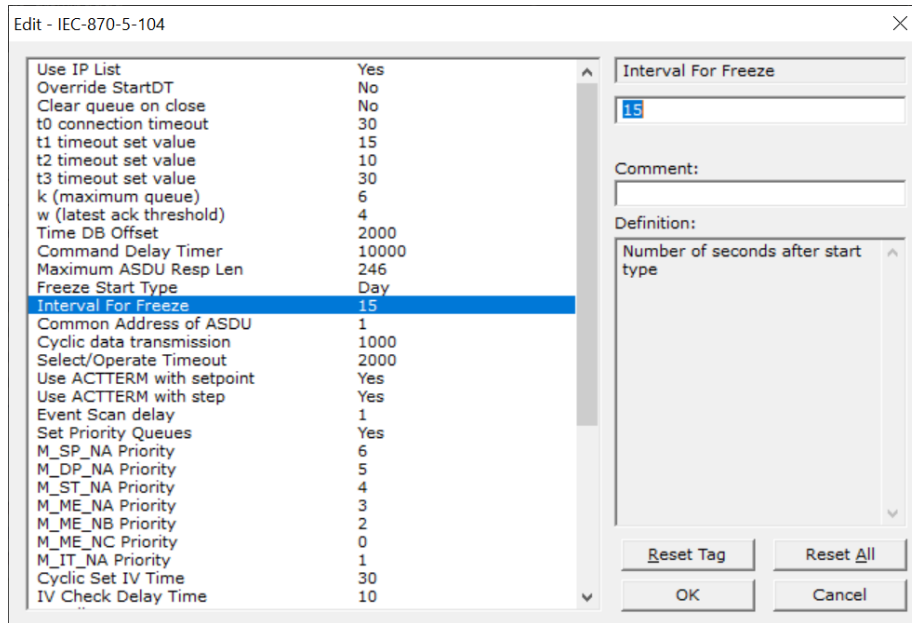

The gateway would send the counter messages every 15 seconds. The gateway would start sending the messages depending on the Freeze Start Type parameter as follows:

Freeze Start Type	Time to Start Sending Messages
D	03/26/2004 00:00:00
H	03/25/2004 19:00:00
M	03/25/2004 18:08:00

Example II - Freeze Start Type

If the gateway should send the counter points on the hourly turnaround time and also 45 minutes later, the Mode A parameters should be configured as follows:

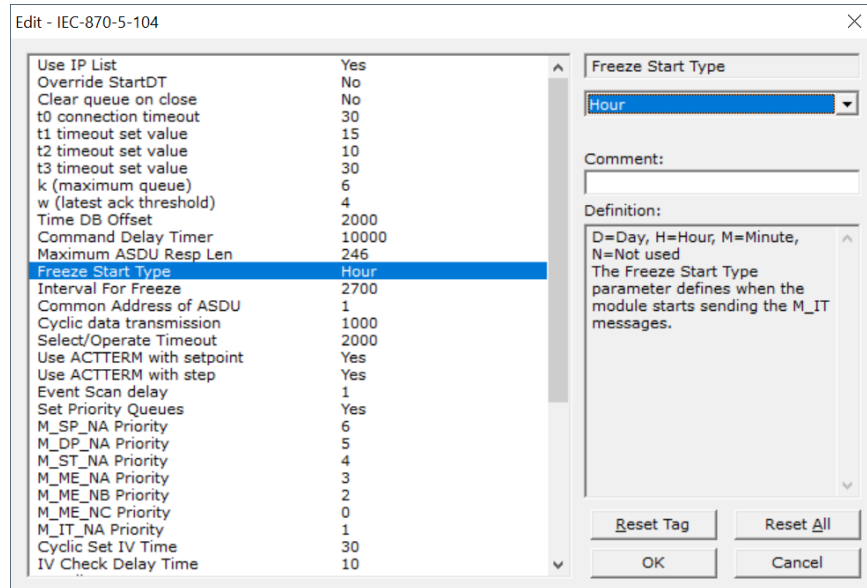

The gateway would send events as follows (Hours:Minutes:Seconds):

- 17:00:00
- 17:45:00
- 18:00:00
- 18:45:00
- 19:00:00
- 19:45:00

Mode D

To select the Mode D, configure the Freeze Start Type parameter as "N". For this mode the master would periodically send Counter Interrogation Commands to perform the freeze operation. After the values are frozen the gateway will return the counter points as events. The counter points must be properly configured for counter interrogation groups for Mode D operation.

3.3.2 Monitor Points Addressing

As discussed before, the monitor points must be configured in a database area in the PLX32 gateway.

The monitor data types are described in the following table:

Data Type	Data Size	Addressing Type
M_SP_NA	1 bit	Bit
M_DP_NA	2 bits	Bit
M_ST_NA	1 byte	Byte
M_ME_NA	1 word	Word
M_ME_NB	1 word	Word
M_ME_NC	2 word	Double-Word
M_IT_NA	2 word	Double-Word
M_BO_TB	2 word	Double-Word

(Available for the PLX32-MBTCP-104 v1.005.019 and newer, using PCB v4.8.0.018 and newer)

M SP NA

A Monitored Single-Point occupies one binary bit and uses bit-addressing. For example, if you configured the following points as shown:

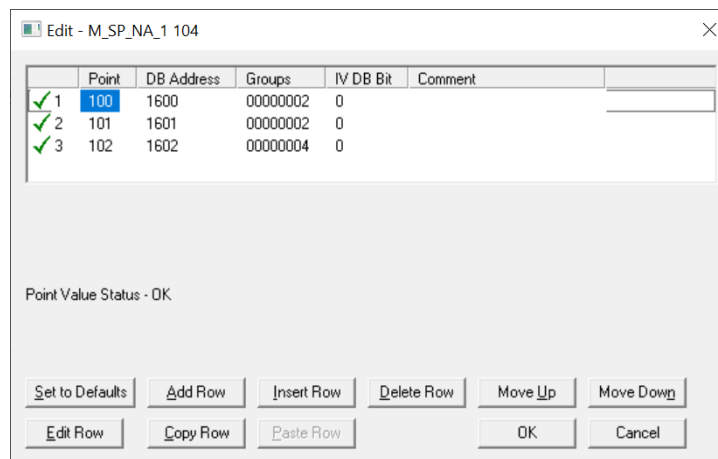

The following table describes how these points would be stored in the PLX32 gateway memory database.

Inf. Object Address	Gateway Database Address
100	Bit 0 of word 100 (Bit address 1600)
101	Bit 1 of word 100 (Bit address 1601)
102	Bit 2 of word 100 (Bit address 1602)

M ST NA

A Monitored Step-Point occupies one byte and uses byte-addressing. For example, if you configured the following points:

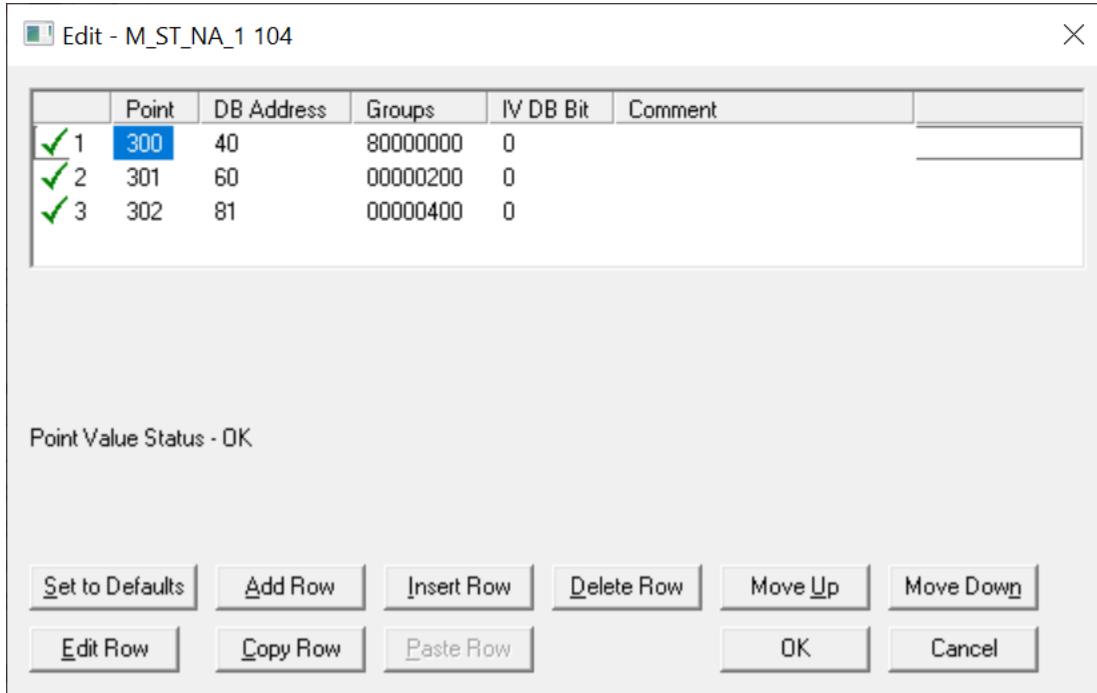

The following table describes how these points would be stored in the PLX32 gateway memory database.

Inf. Object Address	Gateway Database Address
300	Low Byte of word 20 (Byte address 40)
301	Low Byte of word 30 (Byte address 60)
302	High Byte of word 40 (Byte address 81)

M_ME_NA and M_ME_NB

A Monitored Measured Normalized point or Monitored Measured Scaled point occupies one word and uses word-addressing.

For example, if you configured the following points:

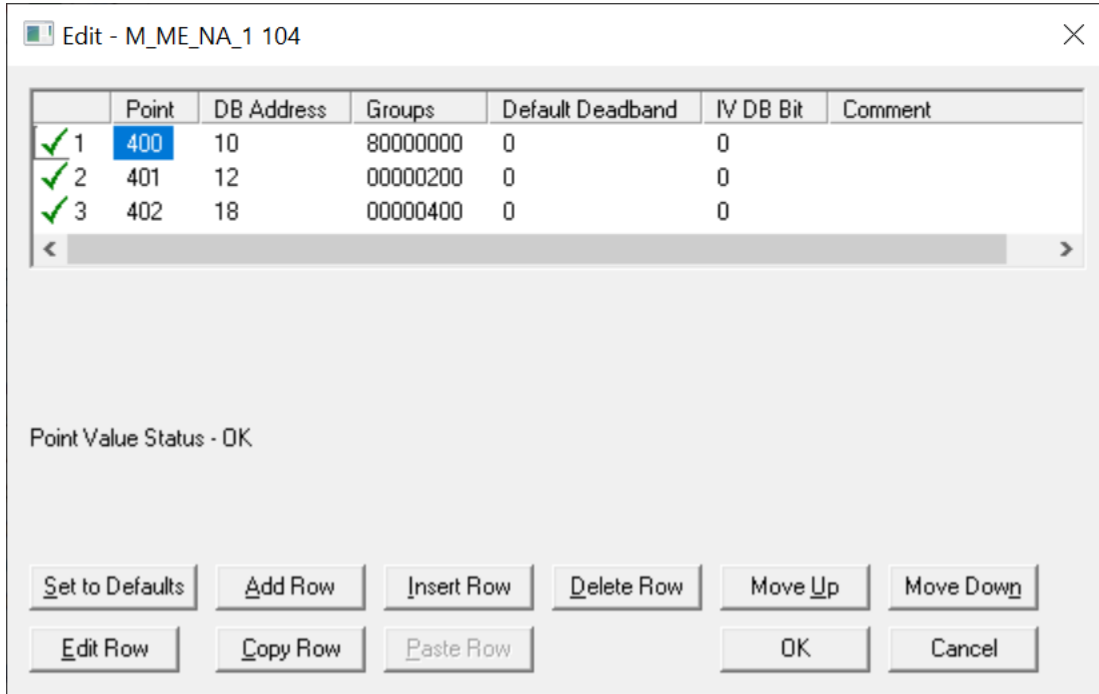

The following table describes how these points would be stored in the PLX32 gateway memory database.

Inf. Object Address	Gateway Database Address
400	Word 10 (Word address 10)
401	Word 12 (Word address 12)
402	Word 18 (Word address 18)

Monitored Measured Normalized points use a data representation defined by the protocol specification to represent fractional decimal values. The following table describes the value for each bit as a reciprocal power of two (2), that is two (2) raised to the power of a negative exponent (-1 through -15). Bit 15 is the Sign Bit.

Bit	15	14	13	12	11	10	9	8	7	6	5	4	3	2	1	0
Value																
Hex	S	2 ⁻¹	2 ⁻²	2 ⁻³	2 ⁻⁴	2 ⁻⁵	2 ⁻⁶	2 ⁻⁷	2 ⁻⁸	2 ⁻⁹	2 ⁻¹⁰	2 ⁻¹¹	2 ⁻¹²	2 ⁻¹³	2 ⁻¹⁴	2 ⁻¹⁵
Decima																
l																
4000h 0.5	0	1	0	0	0	0	0	0	0	0	0	0	0	0	0	0
2000h 0.25	0	0	1	0	0	0	0	0	0	0	0	0	0	0	0	0
1000h 0.125	0	0	0	1	0	0	0	0	0	0	0	0	0	0	0	0
6000h 0.75	0	1	1	0	0	0	0	0	0	0	0	0	0	0	0	0
3210h 0.3957 519531 25	0	0	1	1	0	0	1	0	1	0	1	0	1	0	0	0

Examples:

- A value of 4000hex (only Bit 14 set, all others clear) is interpreted as 0.5 decimal
- A value of 2000hex (only Bit 13 set, all others clear) is interpreted as 0.25 decimal
- A value of 1000hex (only Bit 12 set, all others clear) is interpreted as 0.125 decimal
- Etc...
- A value of 0001hex (Only Bit 0 set, all others clear) is interpreted as 0.000030517578125

Therefore, the actual data values transmitted may be any combination of the decimal values for any given bit pattern.

M ME NC and M IT N

The monitored measured short floating point, monitored integrated total points occupy two words with double-word addressing.

For example, if you configured the following points:

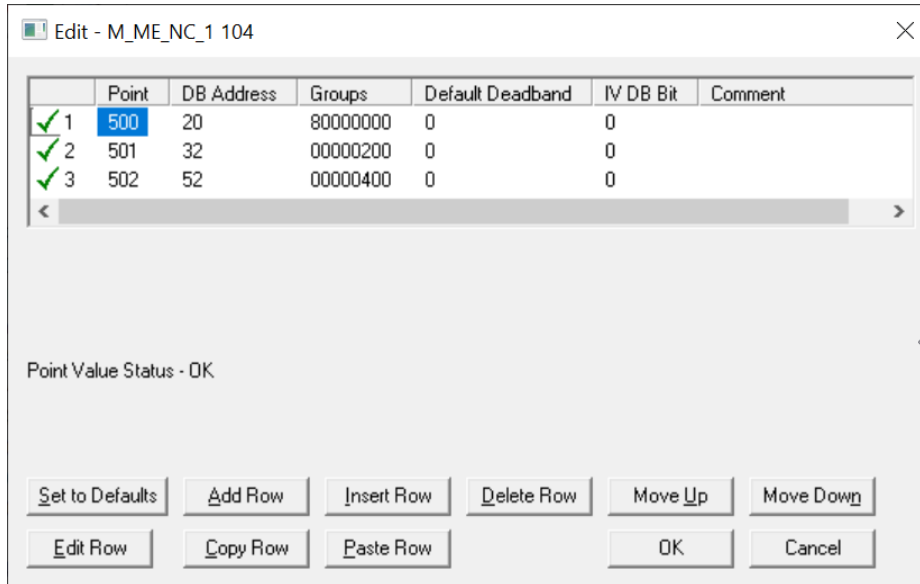

The following table describes how these points would be stored in the PLX32 gateway memory database.

Inf. Object Address	Gateway Database Address
500	Words 40 and 41 (Double-word address 20)
501	Words 64 and 65 (Double-word address 32)
502	Word 104 and 105 (Double-word address 52)

M BO TB

(This parameter applies only to the PLX32-MBTCP-104 v1.005.019 and newer, using PCB v4.8.0.018 and newer)

The monitored 32-bit string points occupy two words with double-word addressing.

The following table describes how these points would be stored in the PLX32 gateway memory database.

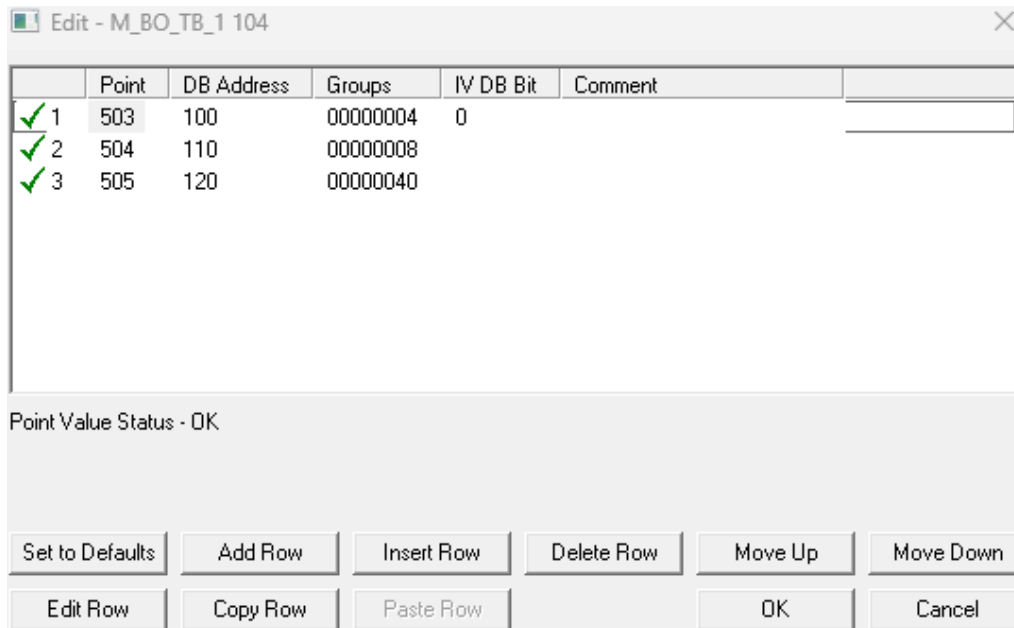

The following table describes how these points would be stored in the PLX32 gateway memory database.

Inf. Object Address	Gateway Database Address
503	Words 200 and 201 (Double-word address 100)
504	Words 220 and 221 (Double-word address 110)
505	Words 240 and 241 (Double-word address 120)

3.4 Using Control (Command) Points

The following control points are supported by the PLX32 gateway:

Symbol	Description
C_SC_NA	Single-Point Command
C_DC_NA	Dual-Point Command
C_RC_NA	Step-Point Command
C_SE_NA	Measured Normalized Point Command
C_SE_NB	Measured Scaled-Point Command
C_SE_NC	Measured Short Floating-Point Command

Each control point is identified by its Information Object Address. For each control point, configure the following parameters:

Parameter	Description
Point #	This is the information object address of the point. It identifies the point in the network. This address must be unique for each Common ASDU Address in the network.
DB Address	This is the database location in the PLX32 gateway associated with the point.
Monitor Point #	Information Object Address of the monitored point to be sent to the client once the control request is received.
Monitor DB Address	Database address associated to the monitor IOA point. Each point occupies one bit in the database.
Require Select	If the Require Select parameter is not set to zero, a select command must be received before an execute command will be processed.

Example (C_SC_NA)

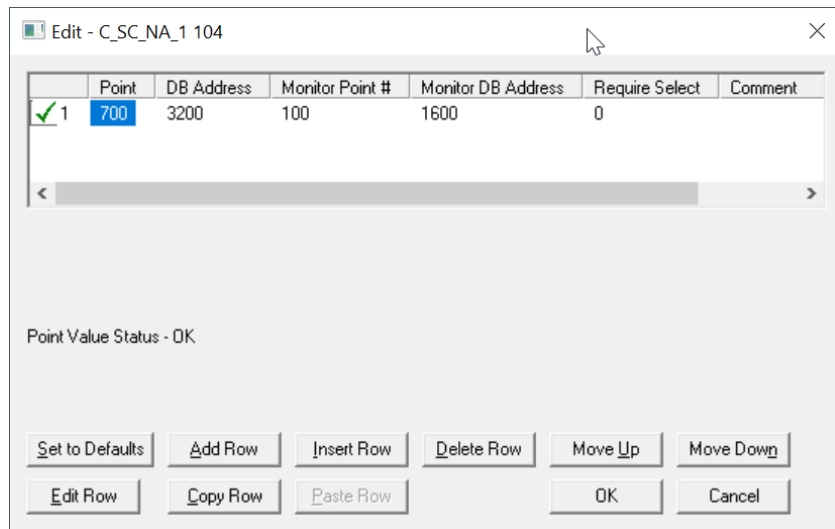

In the example above, each time the gateway receives a command for single- command point 700, it sends a response containing a monitored single-point (information object address 100 with the value at database bit-address 1600).

Require Select: This parameter configures the point to require a *Select* request before the *Operate* command.

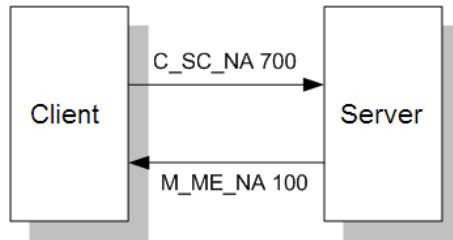

3.4.1 Control Data Transfer

The control communication typically occurs when the client sends a command request to update the gateway’s command points. The data types addressing are described in the following table.

Data Type	Data Size	Addressing Type
C_SC_NA	1 bit	Bit
C_DC_NA	2 bits	Bit
C_RC_NA	1 byte	Byte
C_SE_NA	1 word	Word
C_SE_NB	1 word	Word
C_SE_NC	2 words	Word

Some of the command points may be configured to be selected before executed. Refer to the following parameter to configure the select/operate timeout period. After the gateway receives the SELECT operation it will wait for this period of time for the EXECUTE operation. If the gateway does not receive an EXECUTE operation within this period of time it will require another SELECT operation before the EXECUTE operation.

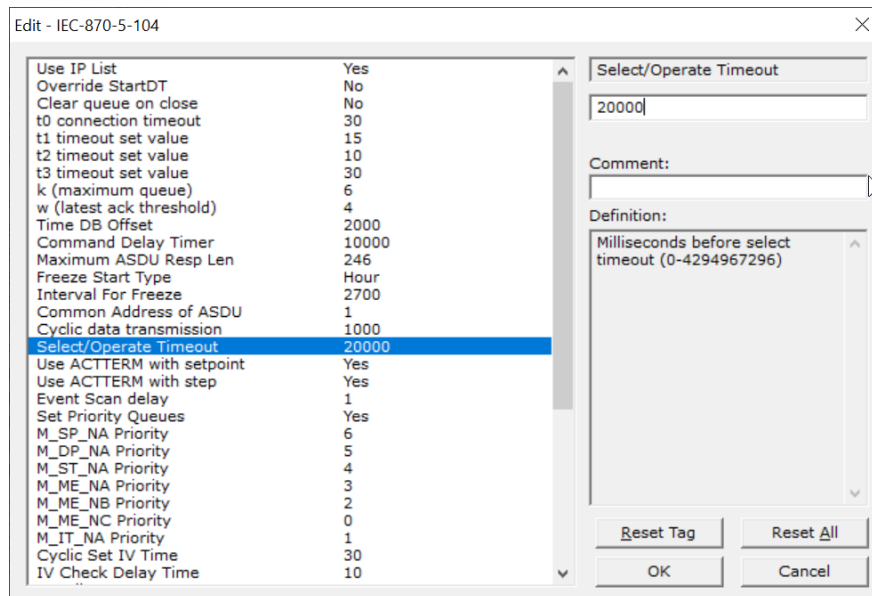

3.4.2 Command Points Addressing

Command points must be configured in a database area that is updated in the gateway memory database. You must associate each point to a database address in the PLX32 gateway. The interpretation of the *DB address* parameter in the configuration tables depends on the point type configured and the type of addressing associated with that point type.

Data Type	Data Size	Addressing Type
C_SC_NA	1 bit	Bit
C_DC_NA	2 bits	Bit
C_RC_NA	1 byte	Byte
C_BO_NA	2 words	Double-word
C_SE_NA	1 word	Word
C_SE_NB	1 word	Word
C_SE_NC	2 words	Double-word

C SC NA and C DC NA

The single-point command and dual-point command points use one bit with bit-addressing. For example, if you configure the following points:

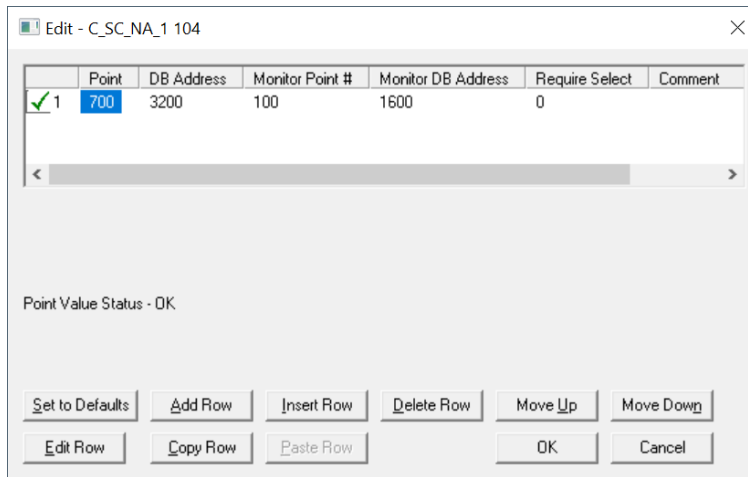

These points would be used as follows:

Inf. Object Address	Module Database Address
100	Bit 0 of word 100
101	Bit 1 of word 100
102	Bit 2 of word 100

The protocol specification defines a qualifier value that is set by the master to determine the duration of the pulse (short, long or persistent). Configure the parameters below to set the duration of the short and long pulses:

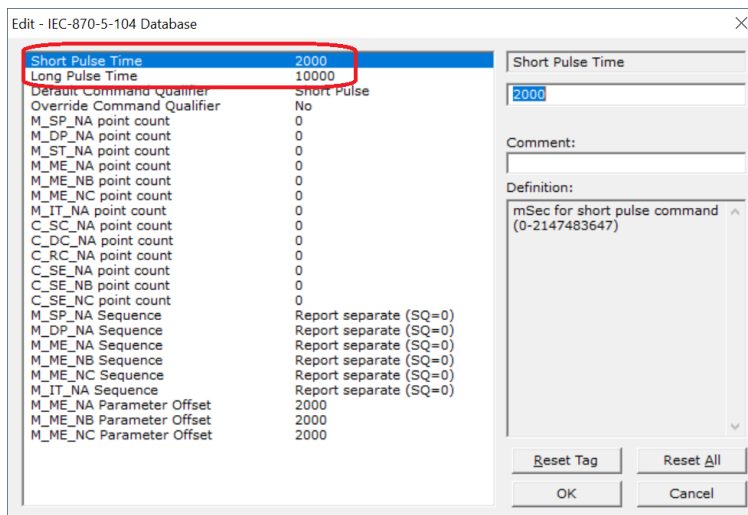

C RC NA

A Step-Point Command point occupies one byte and uses byte-addressing. For example, if you configured the following points:

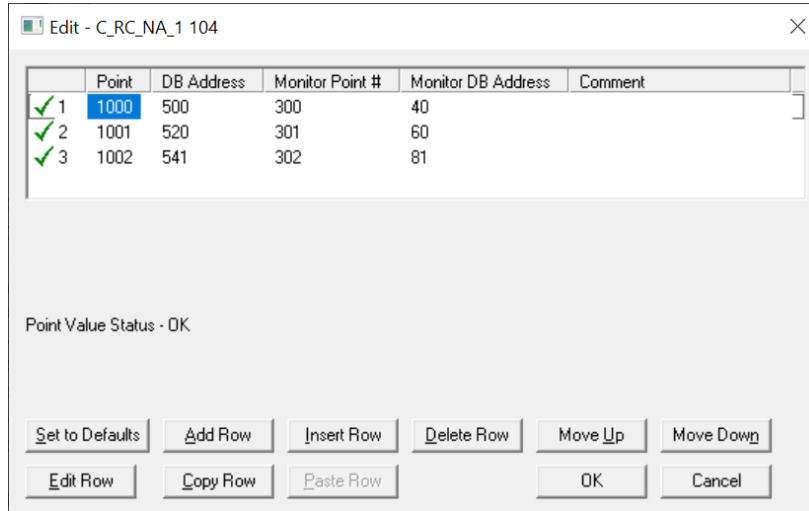

The following table describes how these points would be used.

Inf. Object Address	Gateway Database Address
1000	Low Byte of word 250 (Byte address 500)
300	Low Byte of word 20 (Byte address 40. Must match configuration of point 300 in M_ST_NA.)
1001	Low Byte of word 260 (Byte address 520)
301	Low Byte of word 30 (Byte address 60. Must match configuration of point 301 in M_ST_NA.)
1002	High Byte of word 270 (Byte address 541)
302	High Byte of word 40 (Byte address 81. Must match configuration of point 302 in M_ST_NA.)

C SE NA and C SE NB

The measured normalized point command uses one word with word-addressing. For example, if you configured the following points:

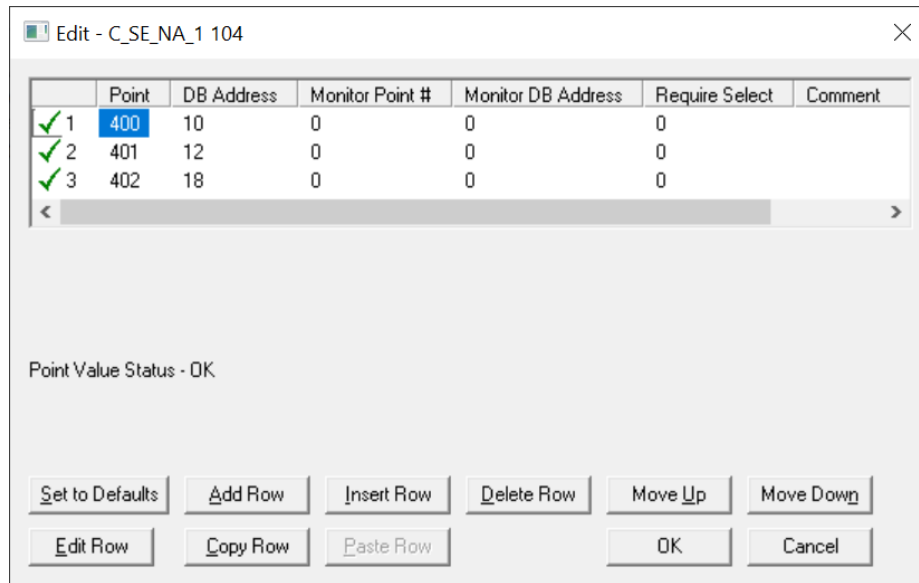

The following table describes how these points would be used.

Inf. Object Address	PLX32 gateway Database Address
1100	Word 2000 (Word address 2000)
400	Word 10 (Word address 10. Must match the configuration of point 400 in M_ME_NA.)
1101	Word 2001 (Word address 2001)
401	Word 12 (Word address 12. Must match the configuration of point 401 in M_ME_NA.)
1102	Word 2001 (Word address 2001)
402	Word 18 (Word address 18. Must match the configuration of point 402 in M_ME_NA.)

The measured normalized points use a data representation defined by the protocol specification to represent fractional decimal values. The following table describes the value for each bit as a reciprocal power of two (2), that is two (2) raised to the power of a negative exponent (-1 through -15). Bit 15 is the Sign Bit.

Bit	15	14	13	12	11	10	9	8	7	6	5	4	3	2	1	0
Value																
Hex	S	2 ⁻¹	2 ⁻²	2 ⁻³	2 ⁻⁴	2 ⁻⁵	2 ⁻⁶	2 ⁻⁷	2 ⁻⁸	2 ⁻⁹	2 ⁻¹⁰	2 ⁻¹¹	2 ⁻¹²	2 ⁻¹³	2 ⁻¹⁴	2 ⁻¹⁵
Decimal																
4000h 0.5	0	1	0	0	0	0	0	0	0	0	0	0	0	0	0	0
2000h 0.25	0	0	1	0	0	0	0	0	0	0	0	0	0	0	0	0
1000h 0.125	0	0	0	1	0	0	0	0	0	0	0	0	0	0	0	0
6000h 0.75	0	1	1	0	0	0	0	0	0	0	0	0	0	0	0	0
3210h 0.3957 519531 25	0	0	1	1	0	0	1	0	1	0	1	0	1	0	0	0

3.4.3 Examples

A value of 4000hex (only Bit 14 set, all others clear) is interpreted as 0.5 (Decimal).

A value of 2000hex (only Bit 13 set, all others clear) is interpreted as 0.25 (Decimal).

A value of 1000hex (only Bit 12 set, all others clear) is interpreted as 0.125 (Decimal).

... etc...

A value of 0001hex (Only Bit 0 set, all others clear) is interpreted as 0.000030517578125.

Therefore, the actual data values transmitted may be any combination of the decimal values for any given bit pattern.

C SE NC

A Measured Short Floating- point Command point occupies two words and uses double word addressing.

For example, if you configured the following points:

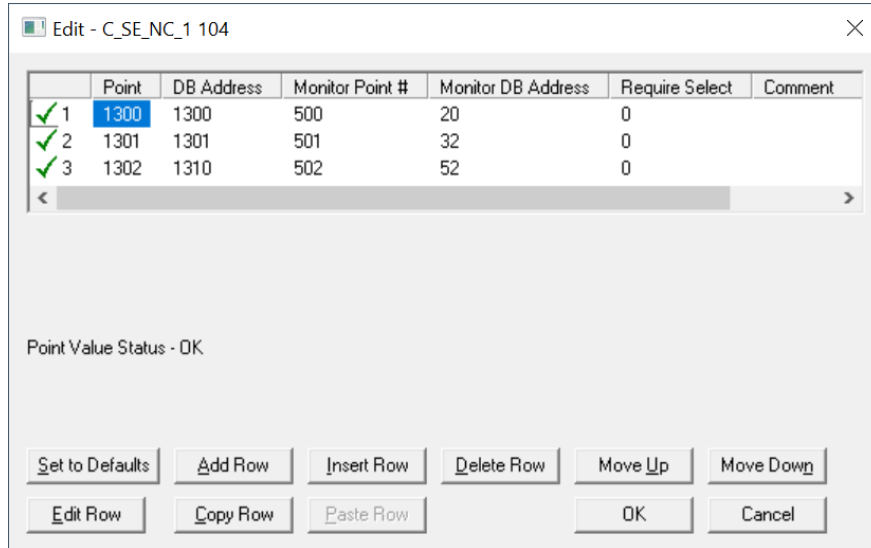

The following table describes how these points would be stored in the PLX32 gateway memory database.

Inf. Object Address	Gateway Database Address
1300	Words 2600 and 2601 (Double-word address 1300)
500	Words 40 and 41 (Double-word address 20. Must match the configuration of point 500 in M_ME_NC.)
1301	Words 2602 and 2603 (Double-word address 1301)
501	Words 64 and 65 (Double-word address 32. Must match the configuration of point 501 in M_ME_NC.)
1302	Words 2620 and 2621 (Double-word address 1310)
502	Word 104 and 105 (Double-word address 52. Must match the configuration of point 502 in M_ME_NC.)

3.5 Data Communication

3.5.1 Group Communication

As previously discussed, the Group parameter in the gateway configuration file controls how each monitored point is transferred between the PLX32 gateway and the client unit. The Group parameter is described on page 43.

The following example configures this point to be repeated either during cyclic polls, or when a General Interrogation request for Group 1 occurs.

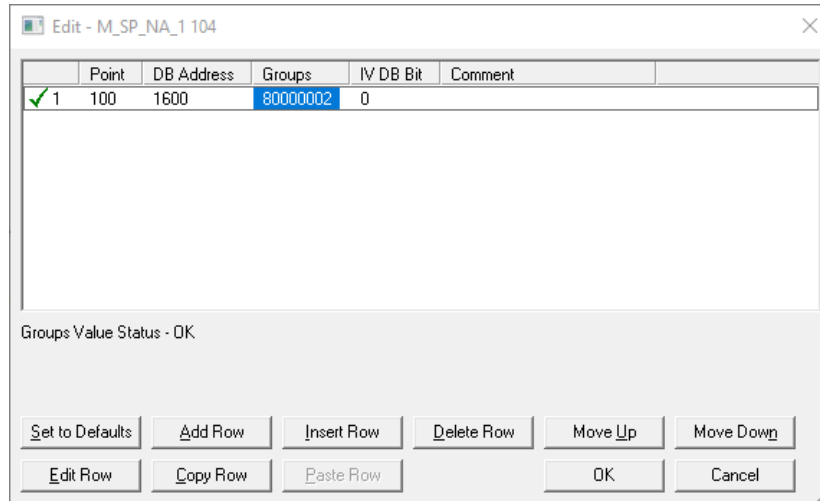

The gateway periodically sends all points configured for periodic/cyclic poll (0x80000000) at the interval in milliseconds configured with the Cyclic Data Transmission parameter:

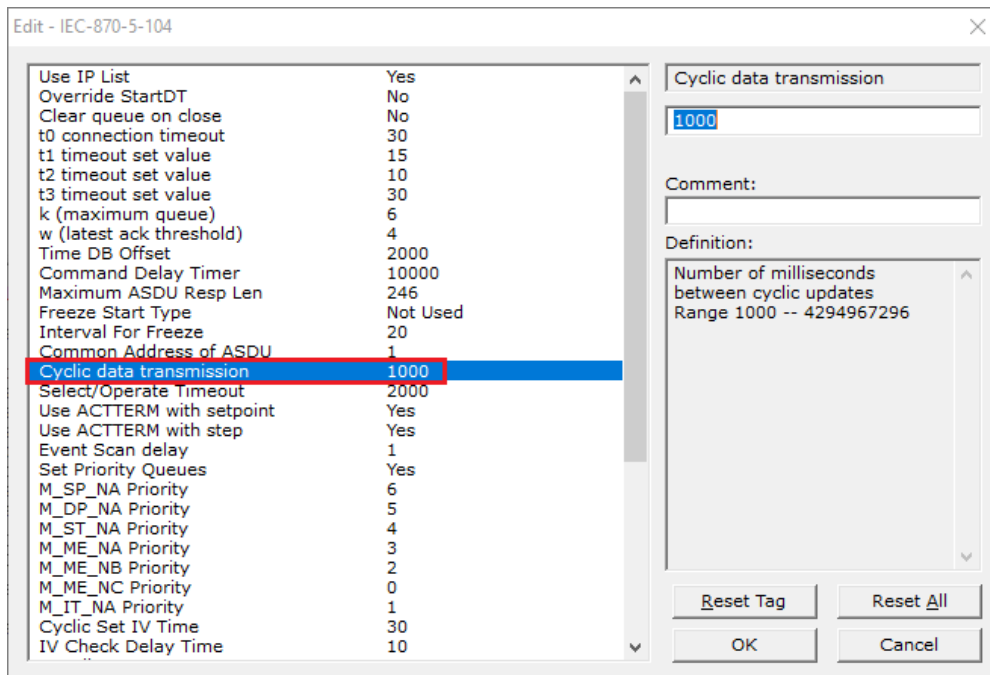

You can also divide the monitored points into different groups, allowing the client to periodically poll only certain points. This also allows some points to be polled more frequently than others.

Note: Configure the counter points (M_IT_NA) for general counter interrogation or group counter interrogations.

3.5.2 STARTDT & STOPDT

STARTDT (Start Data Transfer) and STOPDT (Stop Data Transfer) are used by the client to control the data transfer from the PLX32 gateway. When the connection is established, user data is not automatically enabled in the server until it receives a STARTDT act request from the client. The server should respond with a STARTDT con response to acknowledge the client request. Once this procedure is concluded, the server can send monitor data to the client.

The client can interrupt the monitor data flow at any time sending a STOPDT act command to the server.

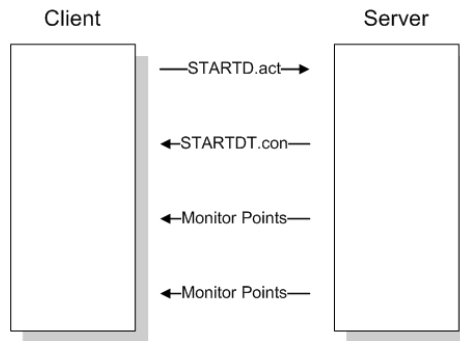

In some circumstances the client unit may not support STARTDT and STOPDT messages. The gateway may also be tested with simulator software that does not support these features. During these situations, you may want to disable the STARTDT and STOPDT features using the following parameter:

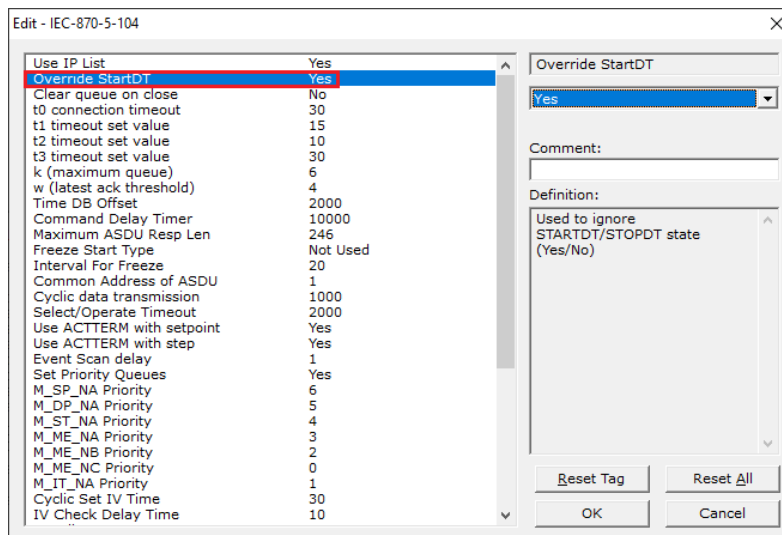

If this parameter is set to 1, the gateway will ignore the STARTDT and STOPDT requests by the client unit.

3.5.3 TESTFR Requests

Connections that are unused (but opened) may be periodically tested in both directions by sending test messages (TESTFR=act) which are confirmed by the receiving station sending TESTFR=con messages. The PLX32 gateway can be configured to periodically send this message using the following parameter:

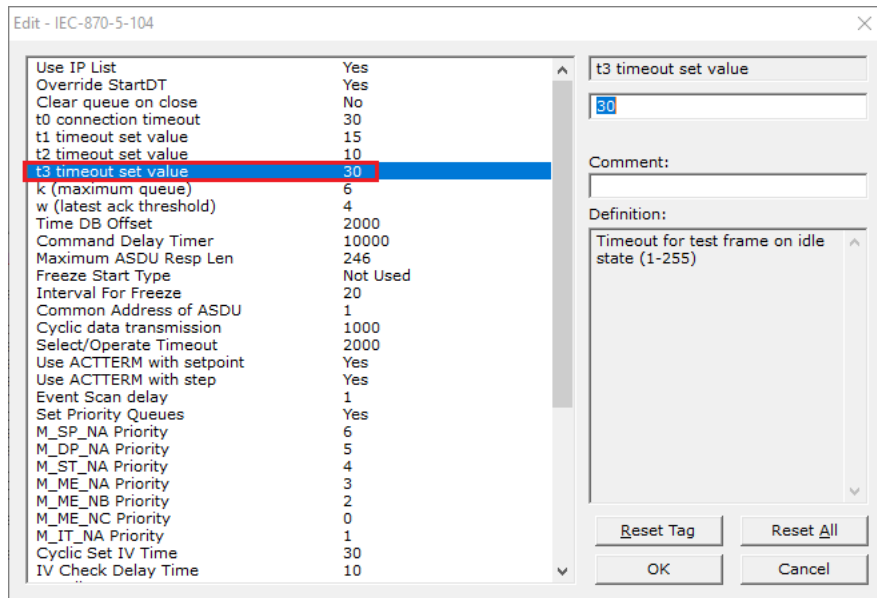

In the example above, the gateway would send a TESTFR.ACT message 30 seconds after receiving the last message:

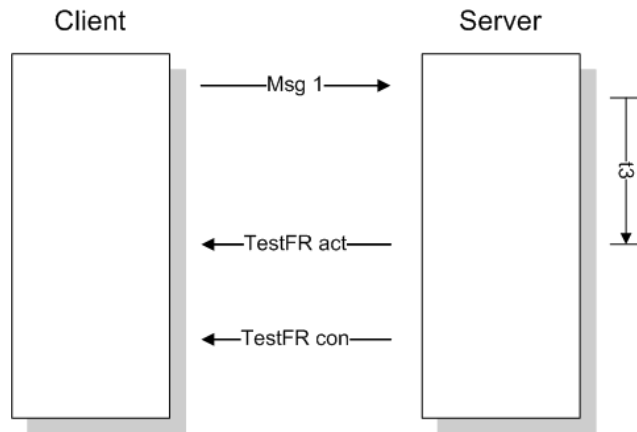

If the gateway does not receive the TESTFR.con message within a certain amount of time, it will timeout and close the connection. You can configure the timeout period using the following parameter:

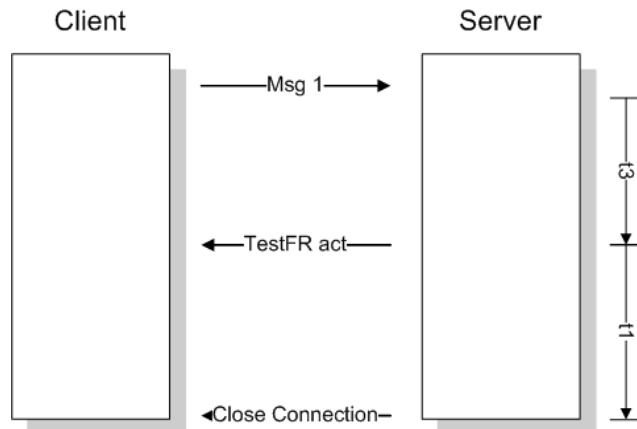
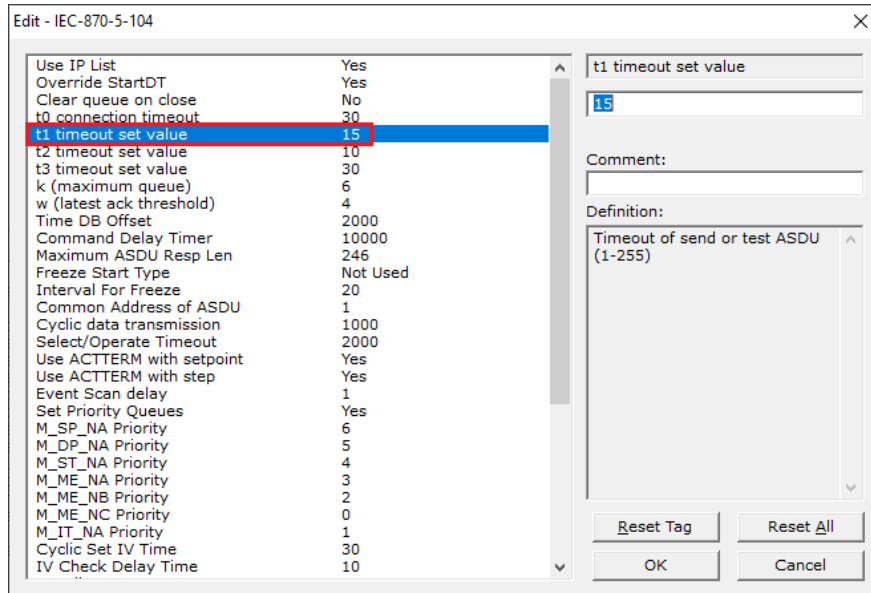

When closing the connection, the gateway can be configured to clear all the messages in its queue. The following parameter is used to implement this task:

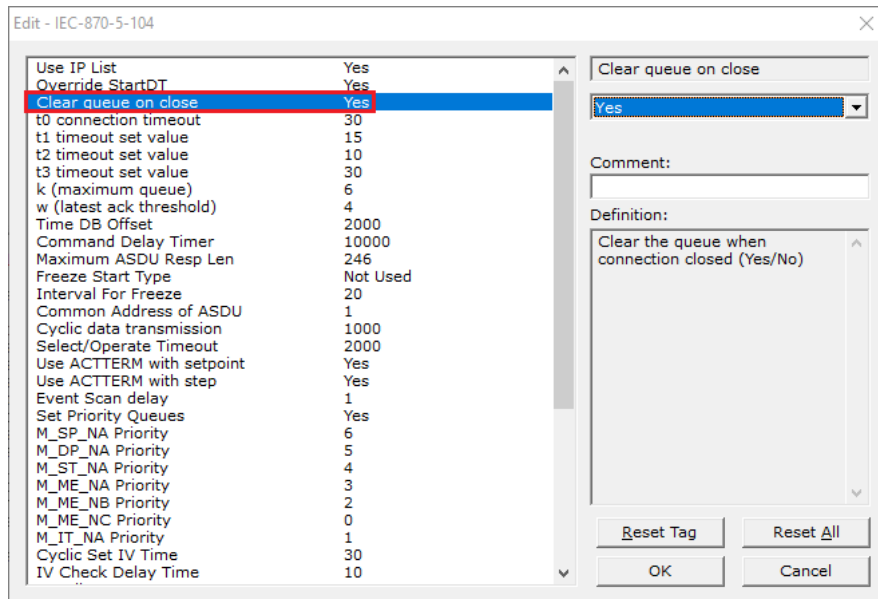

The configuration above would cause to gateway to delete all pending messages/events while closing the connection to the client.

3.6 Events

In order to improve communication efficiency, most applications will require the client to periodically poll for data changes with a higher priority than polling for other monitored data. Every time a data point changes, the server can send this information as an event, typically with date and time information indicating when the change occurred.

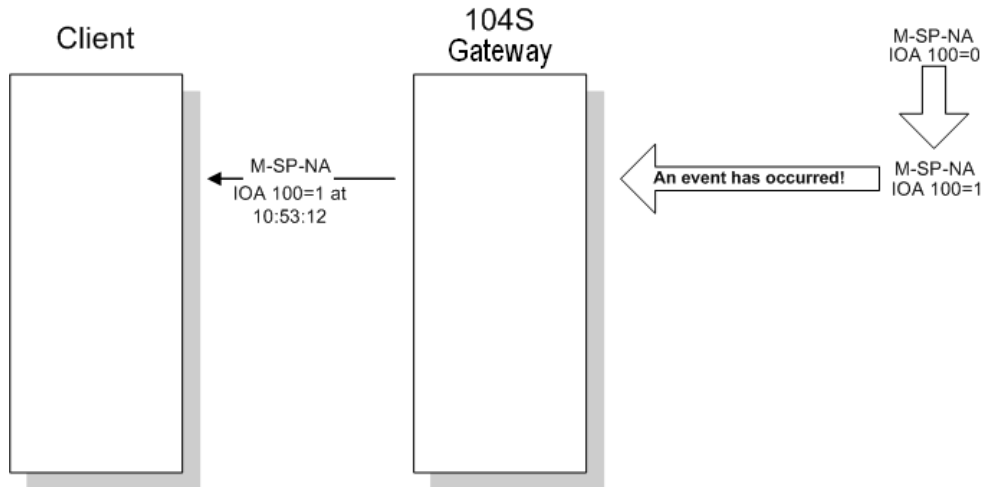

The gateway supports a buffer queue of 1000 events per data type. When the queue is full, the gateway will delete the oldest event in the queue, replacing it with the newest event received for that data type.

Note: Firmware versions prior to PLX32-EIP-104 v1.006.012 and PLX32-MBTCP-104 v1.005.028 support a buffer queue of 99 events per data type.

3.6.1 Deadbands

The Monitored Measured points (M_ME_NA and M_ME_NB) will generate events only if the data value changes an amount greater than or equal to the configured deadband value.

For example, with the following point configured:

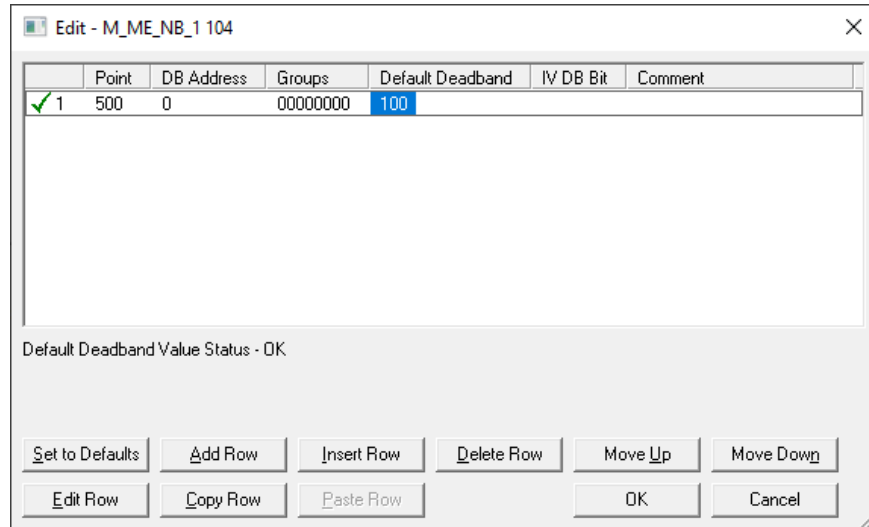

If the current value for this point is 130, it would only generate an event, only if: NEW VALUE is less than or equal to 30, or NEW VALUE is greater than or equal to 230. You can set the deadband for each Monitored Measured point through the configuration file.

The Client may also dynamically change the deadband for each Monitored point. The Client may send one of the following commands:

Type	Command
110	Parameter of Measured Normalized Data (M_ME_NA)
111	Parameter of Measured Scaled Data (M_ME_NB)
112	Parameter of Measured Short Floating Point (M_ME_NC)

The protocol specification explains that the qualifier value for these commands should be configured as:

Bits	Value	Description
1 to 6	0	Not Used
	1	Threshold Value (Deadband)
	2	Smoothing Factor (filter time constant) - Not Supported
	3	Low Limit Transmission of Measured Value
	4	High Limit Transmission of Measured Value
	5 to 31	Reserved
7	0	No Change
	1	Change
8	0	Operation
	1	Not in Operation

For the PLX32 gateway, the Low Limit and High Limit parameters cannot be changed by command, because these values are calculated as follows:

Low Limit = (LAST REPORTED VALUE) - Deadband
High Limit = (LAST REPORTED VALUE) + Deadband

These commands must be sent to a specific Information Object Address. The PLX32 gateway associates each Monitor Measured point with a Parameter point using Parameter Offset entries:

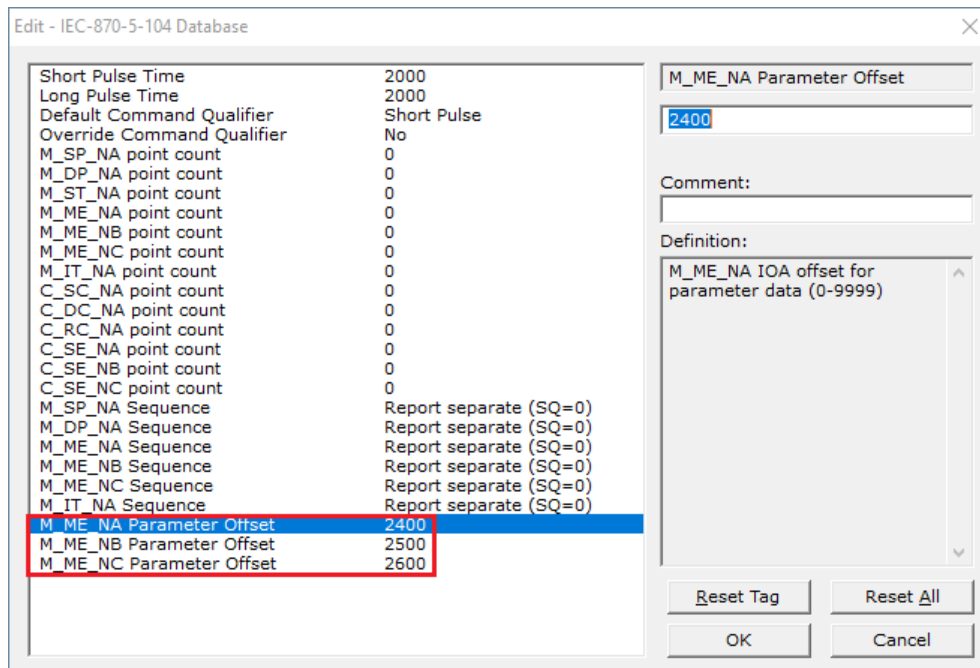

Example:

Assume the following Monitored Measured points are configured as shown:

```
[M_ME_NA_1 104]
#
# IOA          DB Address   Group(s)   Default   IV DB Bit
# -----
START
    400          10     00000002   100      # P1 suction pressure
    401          11     00000002   100      # P1 discharge pressure
    402          12     00000002   100      # P2 suction pressure
    403          13     00000002   100      # P2 discharge pressure
    404          14     00000002   100      # Station discharge pressure
    405          15     00000002   100      # VSD speed
    406          16     00000002   100      #
    407          17     00000002   100      #
    408          18     00000002   100      #
    409          19     00000002   100      #
END
```

```
[M_ME_NB_1 104]
#
# IOA          DB Address   Group(s)   Default   IV DB Bit
# -----
START
    500          20     00000002   100      # P1 inboard bearing temp
    501          21     00000002   100      # P1 outboard bearing temp
    502          22     00000002   100      # P1 winding Temp
    503          23     00000002   100      # P1 current
    504          24     00000002   100      # P2 inboard bearing temp
    505          25     00000002   100      # P2 outboard bearing temp
    506          26     00000002   100      # P2 winding Temp
    507          27     00000002   100      # P2 current
    508          28     00000002   100      #
    509          29     00000002   100      #
END
```

```
[M_ME_NC_1 104]
#
# IOA          DB Address   Group(s)   Default   IV DB Bit
# -----
START
    600          30     00000002   100      #
    601          32     00000002   100      #
    602          34     00000002   100      #
    603          36     00000002   100      #
    604          38     00000002   100      #
    605          40     00000002   100      #
    606          42     00000002   100      #
    607          44     00000002   100      #
    608          46     00000002   100      #
    609          48     00000002   100      #
END
```

And assume the Parameter Offsets are configured as shown:

```
M_ME_NA Parameter Offset : 2400 #M_ME_NA IOA offset for
parameter data M_ME_NB Parameter Offset : 2500 #M_ME_NB IOA
offset for parameter data M_ME_NC Parameter Offset : 2600
#M_ME_NC IOA offset for parameter data
```

It would imply that the parameter points would be configured as follows:

M_ME_NA

Monitored Measured Normalized Point	Associated Parameter Point
400	2400
401	2401
402	2402
403	2403
...	...
409	2409

In order to send a change of deadband for M_ME_NA Point 400, the client would send a command type 110 to point 2400.

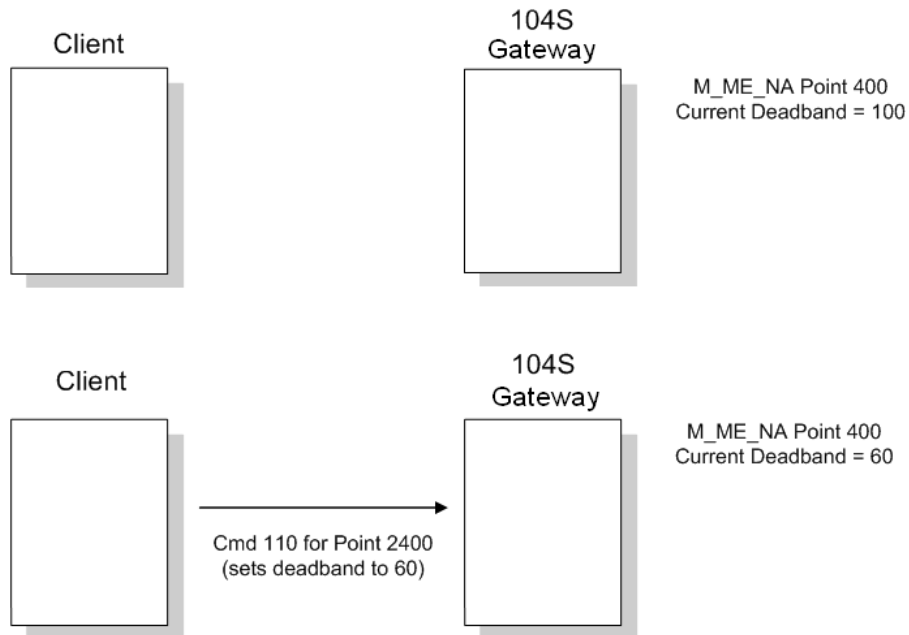

M_ME_NB

Monitored Measured Normalized Point	Associated Parameter Point
500	2500
501	2501
502	2502
503	2503
...	...
509	2509

In order to send a change of deadband for M_ME_NB Point 500, the client would send a command type 110 to point 2500.

M_ME_NC

Monitored Measured Normalized Point	Associated Parameter Point
600	2600
601	2601
602	2602
603	2603
...	...
609	2609

In order to send a change of deadband for M_ME_NC Point 600, the client would send a command type 110 to point 2600.

3.6.2 Controlling the Generation of Events

Some applications may require that only some points should generate events. The application will receive current values from points which have not been configured to generate events only by issuing a poll request, or what the protocol specification calls an interrogation. Other applications may require that all configured points generate events. The PLX32 gateway offers much flexibility for event control. You may control whether or not events will be generated at three (3) different levels:

- 1) At the General Application Level (all configured points of all types)
- 2) At the Data Type Level (all configured point in each data type)
- 3) At the Individual Point Level (any specific point of any data type)

General (All Points)

The user may control how frequently the gateway will scan the database for events using the following configuration parameter:

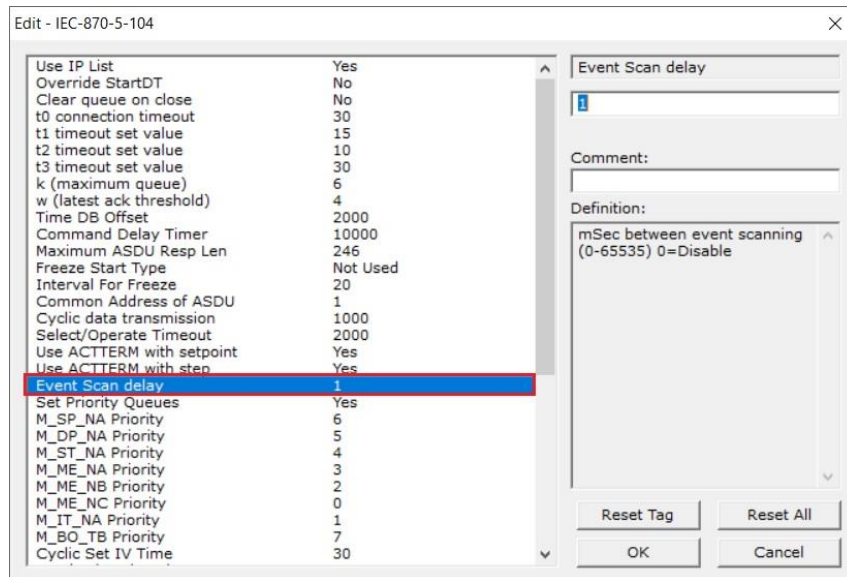

If this parameter is set to 0, the gateway will not generate events for any points. A non-zero value will configure how frequently the module gateway can for events in the database.

Data Type Level

The user may configure if a data type should generate events or not. Each data type has a configuration parameter to control the generation of events:

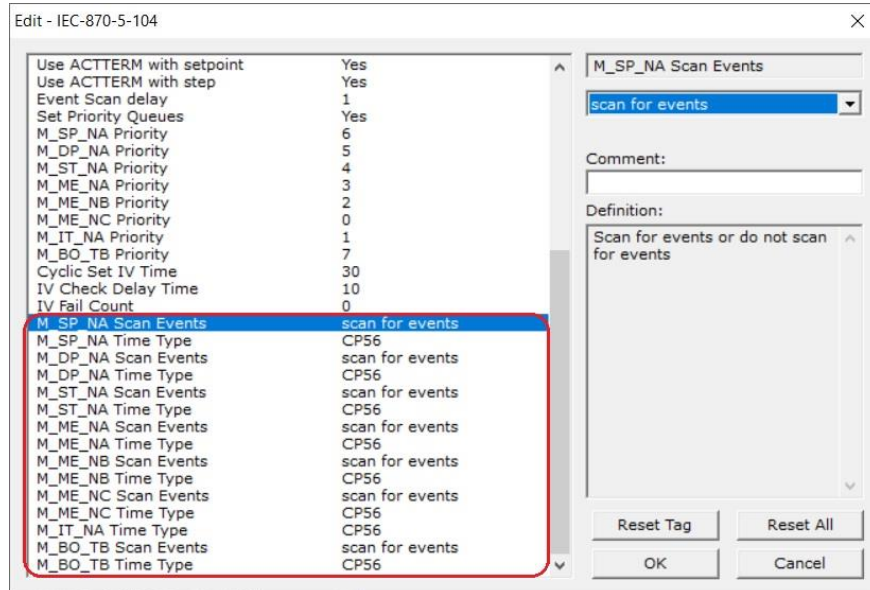

In the example above, only the *M_SP_NA* points would generate events.

Note: The *M_BO_TB Scan Events* and *M_BO_TB Time Type* parameters apply only to the PLX32-MBTCP-104 v1.005.019 and newer, using PCB v4.8.0.018 and newer.

Point Level

You can configure whether or not each point should generate events on a point- by-point basis by using the Group field for each point configuration. Set the value as 40000000 to disable the generation of events for any specific point.

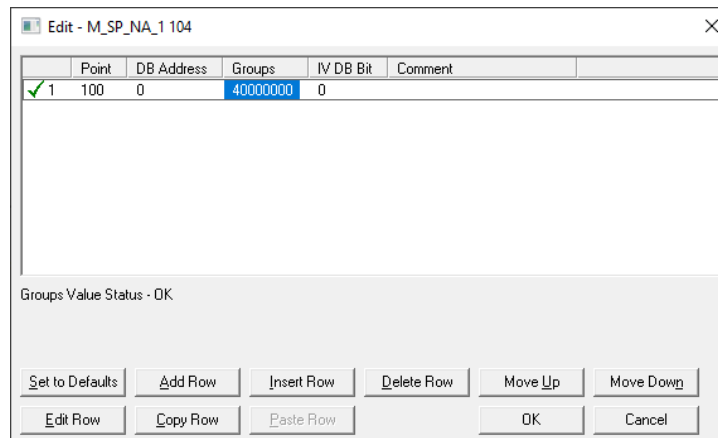

3.6.3 Event Priority

Event Priority permits ASDUs that generate events to be placed in priority queues that are set by the user. The configuration file contains the following parameters to support this feature:

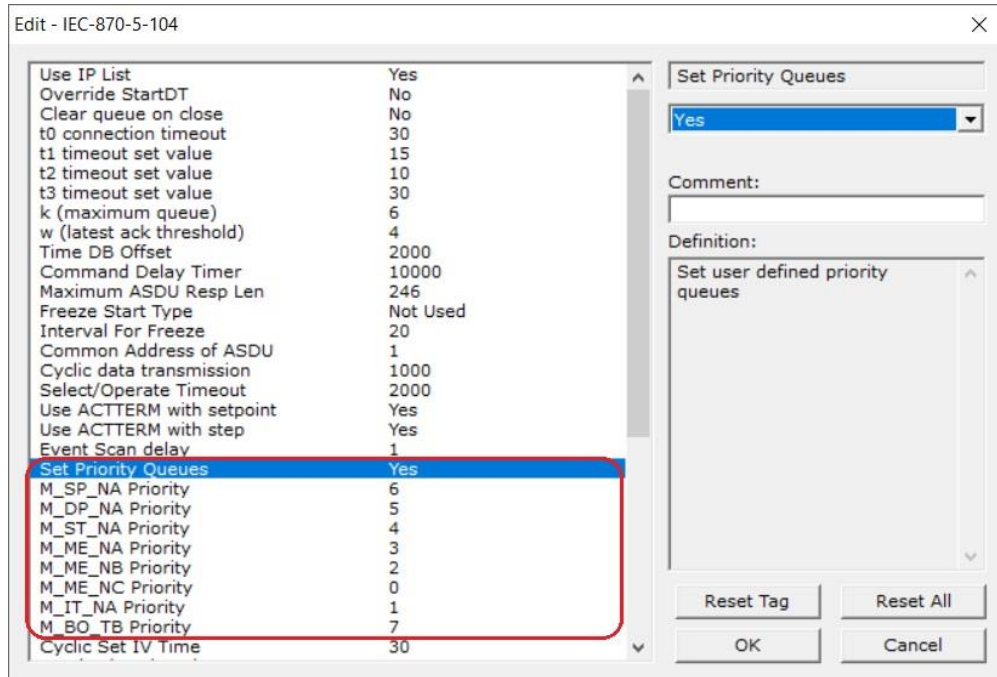

Note: The *M_BO_TB Priority* parameter applies only to the PLX32-MBTCP-104 v1.005.019 and newer, using PCB v4.8.0.018 and newer.

The *Set Priority Queues* parameter must be enabled for this feature to be used. Each of the ASDUs affected by this feature must be assigned a unique priority index from 0 to 6 (for PLX32-EIP-104) and 0 to 7 (for PLX32-MBTCP-104). Events of the ASDU with a priority of 0 will always be reported before any others when they are present.

Example - Event Priority

If the gateway is configured with the example values above, and the event queue contains the events generated in the following order:

Event Order	ASDU
1	M_SP_NA
2	M_SP_NA
3	M_DP_NA
4	M_ST_NA
5	M_DP_NA
6	M_SP_NA

The gateway will respond to a class one data request from the controlling station by returning the data in the event queue in the order shown in the following table.

Packet Order	Content
1	M_DP_NA events 3 and 5
2	M_SP_NA events 1, 2 and 6
3	M_ST_NA event 4

Note that the events are packed into messages in order to maximize the efficiency of the network. The following warning must be considered when deciding to use this feature: Because events from the highest priority queues are always reported when present before lower priority queues, events in the lower queues may be lost due to buffer overflow.

If this feature is not utilized, each ASDU's events are stored in their own queue. The gateway will report each queue containing events in a round-robin fashion with all the data for each ASDU being packed. This methodology limits the possibility of a buffer overflowing and still maximizes the use of bandwidth on the communication channel.

3.6.4 Invalid Bit Monitoring

This feature allows the application to set the invalid (IV) quality bit of the protocol for all the monitored ASDU types supported. If the feature is enabled, the status of each point configured by the user can have the individual IV quality bit determined by the other gateway protocol.

The parameters required to support this feature are:

- Cyclic Set IV Time
- IV Check Delay Time
- IV Fail Count

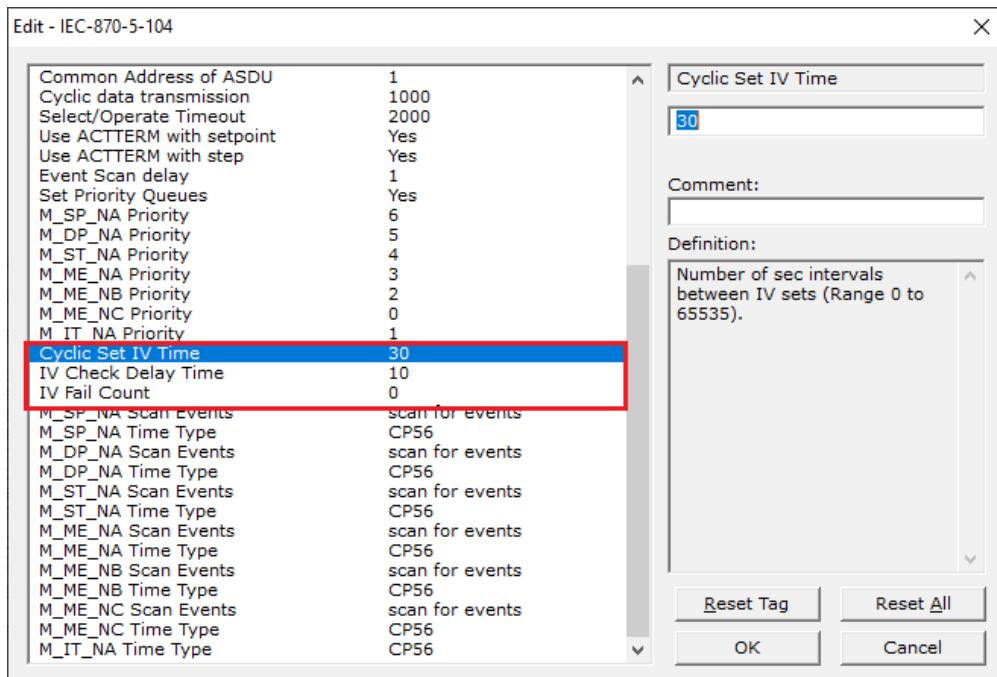

To disable this feature, set the IV Fail Count parameter to 0. If the IV bit field is absent or set to 0, the invalid quality state for the point will always be reported as valid. If used, the Cyclic Set IV Time parameter must be at least 3 times larger than the IV Check Delay Time.

The CYCLIC SET IV TIME parameter determines the interval at which the driver will set all the IV bits for the points being monitored in the gateway. If the IV bit is ON for the number of times specified by the IV FAIL COUNT parameter, the point is in an invalid state. The driver will check the state of each bit at the frequency determined by the IV CHECK DELAY TIME.

The values for the parameters must permit the driver to properly execute the logic. For example, the value for CYCLIC SET IV TIME should be twice the IV CHECK DELAY TIME, multiplied by the IV FAIL COUNT. If the cyclic timer is set to a smaller value, the logic may not execute correctly.

In order to configure points for this feature, the IV DB BIT field for each data type must be set to the database configuration records in the configuration file. For example:

Edit - M_SP_NA_1 104

	Point	DB Address	Groups	IV DB Bit	Comment
✓ 1	100	0	0FFFFFFF	48	P1-PSHH -- Discharge pres...
✓ 2	101	1	00000001	49	P1-PSH -- High discharge ...
✓ 3	102	2	00000003	50	P1-PSL == Low suction pre...
✓ 4	103	3	00000001	51	P1-FSL -- Low flow

Point Value Status - OK

Edit - M_DP_NA_1 104

	Point	DB Address	Groups	IV DB Bit	Comment
✓ 1	200	16	0FFFFFFF	52	Pump 1 Status
✓ 2	201	18	00000001	52	MOV101 -- position switch
✓ 3	202	20	00000001	52	MOV102 -- position switch
✓ 4	203	22	00000001	52	MOV103 -- position switch

Point Value Status - OK

Edit - M_ME_NA_1 104

	Point	DB Address	Groups	Default Deadband	IV DB Bit	Comment
✓ 1	400	10	0FFFFFFF	2000	53	P1 suction pressure
✓ 2	401	11	00000001	100	53	P1 discharge pressure
✓ 3	402	12	00000001	5000	53	P2 suction pressure

Point Value Status - OK

The following illustration shows how these parameters are implemented:

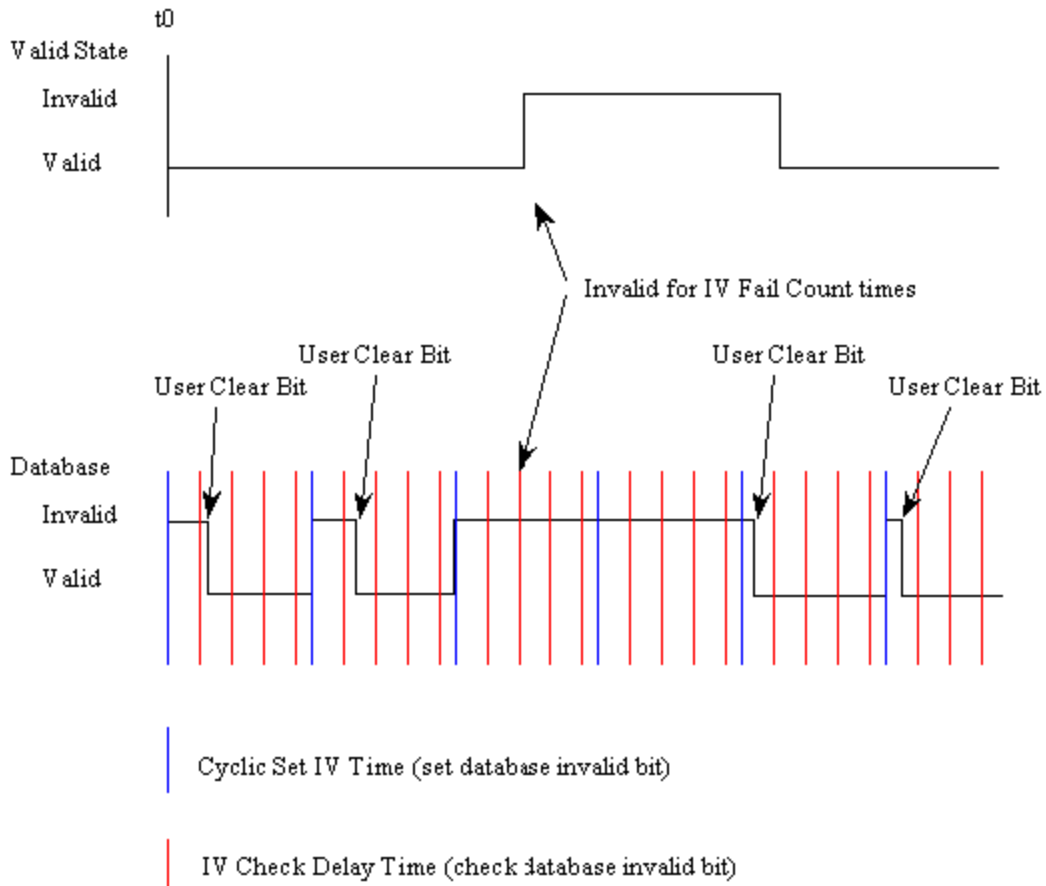

If a database bit address (0 to 159,999) is present, the application may consider the point with an invalid flag if the previous logic checks the IV bit as 1 during consecutive IV Check Delay scans. The IV bits would have to be reset to 0 to set the point to valid state. The IV DB bit defined for each point can be unique, or many points may share the same bit. The last case could be used when the points on an I/O gateway are to be considered as one set. In this case only a single bit is required. For a point that is the result of a computation, the valid quality state could be set for each point individually.

3.6.5 Time Information

Each event may also send the date and time when it has occurred. The PLX32 gateway supports the CP56 time format (as defined in the protocol specification). This format contains the milliseconds, seconds, minute, hour, day, month and year when the event has occurred.

The PLX32 gateway may also be configured not to send any time information with each event for certain data types.

The following "Time Type" parameters may be used to control the time information for each data type:

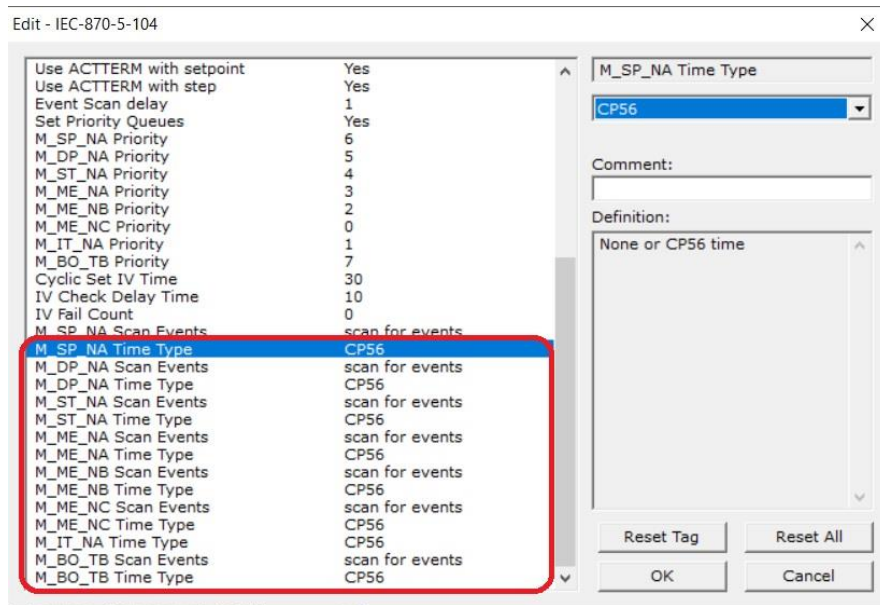

Note: The *M_BO_TB Scan Events* and *M_BO_TB Time Type* parameters apply only to the PLX32-MBTCP-104 v1.005.019 and newer, using PCB v4.8.0.018 and newer.

Note: The client should send a Time Synchronization command to the gateway to synchronize its date and time information, according to the protocol specifications. Depending on certain parameters, as well as hardware limitations, the gateway may present some time delay over time. The client should periodically send time synchronization requests to the PLX32 gateway.

3.7 Sequence Flag

In order to save bandwidth, you can configure the gateway to use the Sequence Flag feature in the *IEC-870-5-104 Database* menu:

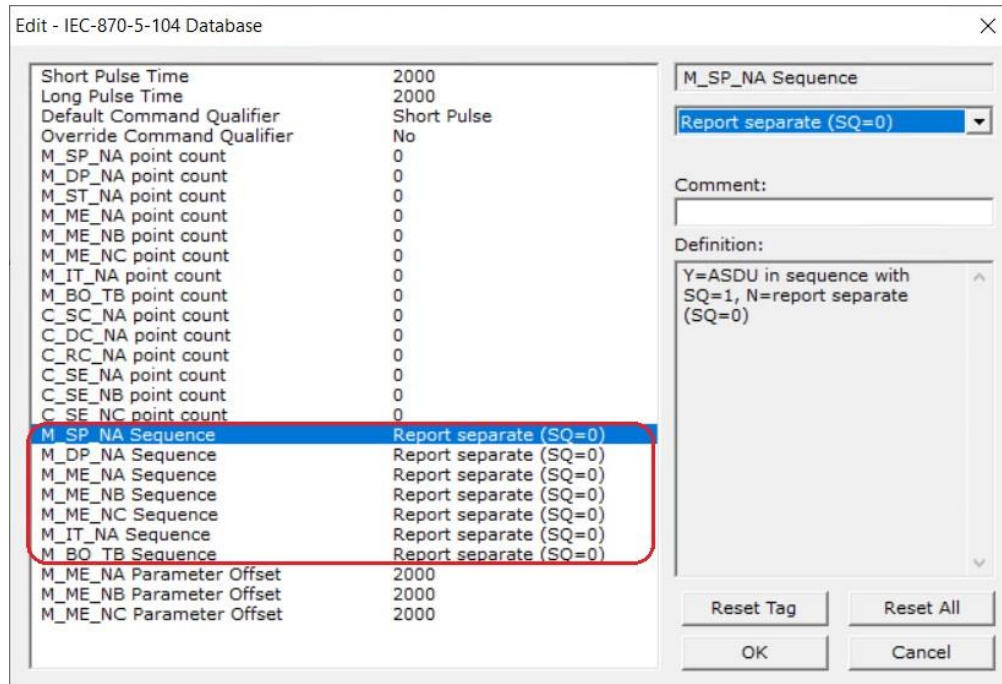

Note: The *M_BO_TB Sequence* parameter applies only to the PLX32-MBTC-104 v1.005.019 and newer, using PCB v4.8.0.018 and newer.

If this parameter is set to *N* (No), this feature is not selected, the gateway will send the object address and value for every monitored point sent to the Client, and the Sequence Flag (SQ) will be set to zero (0).

If this parameter is set to *Y* (Yes), this feature is selected, the gateway will send the object point address and value for only the first point of a sequence of points, send only the data value without point address for any remaining points in the sequence, and the Sequence Flag (SQ) will be set to one (1). When SQ = 1, the Client assumes that all points after the first point use information object addresses in a contiguous order (using the first point as the reference starting address).

Note: Refer to the client device specification to verify if this feature is supported before you consider using it.

4 Diagnostics and Troubleshooting

There are two ways to troubleshoot PLX32 gateways:

- The LEDs located on the front of the gateway
- The Debug port provides a view into the PLX32 gateway's internal database.

4.1 Configuration/Debug Menu

The Configuration and Debug menu for this gateway is arranged as a tree structure, with the Main Menu at the top of the tree, and one or more sub-menus for each menu command. The first menu you see when you connect to the gateway is the Main menu.

4.1.1 Using the Diagnostic Window in ProSoft Configuration Builder

This section explains how to connect to the PLX32 gateway's Diagnostics menu in PCB.

- 1 In PCB, right-click on the PLX32 gateway icon and select **DIAGNOSTICS**.

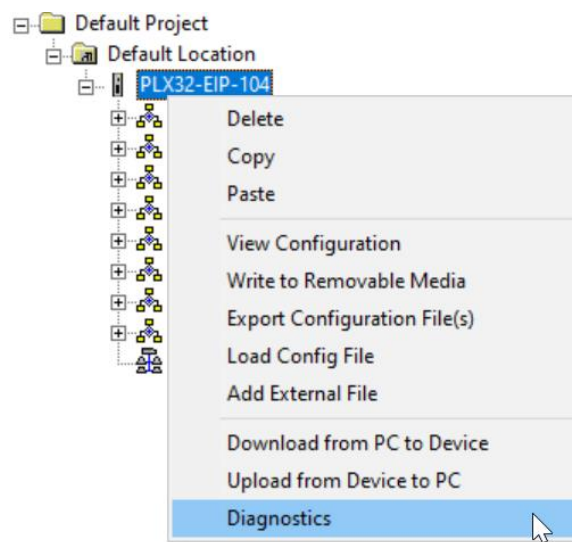

2 This action opens the *Diagnostics* dialog box.

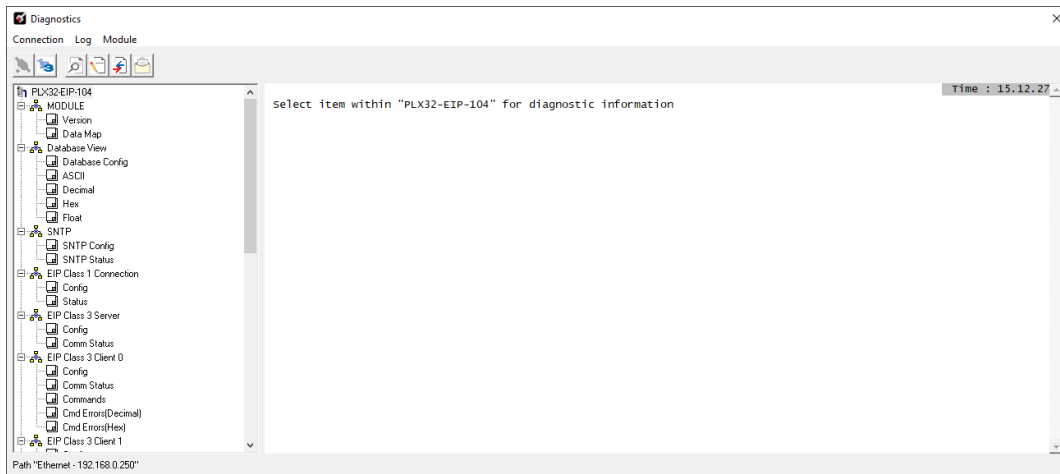

Important: The illustrations of configuration/debug menus in this section are intended as a general guide, and may not exactly match the configuration/debug menus in your own gateway.

4.1.2 IEC 60870-5-104 Server Menu

The *IEC 60870-5-104 SERVER* diagnostic menu allows you to monitor the configuration, status, and points of the 104 driver.

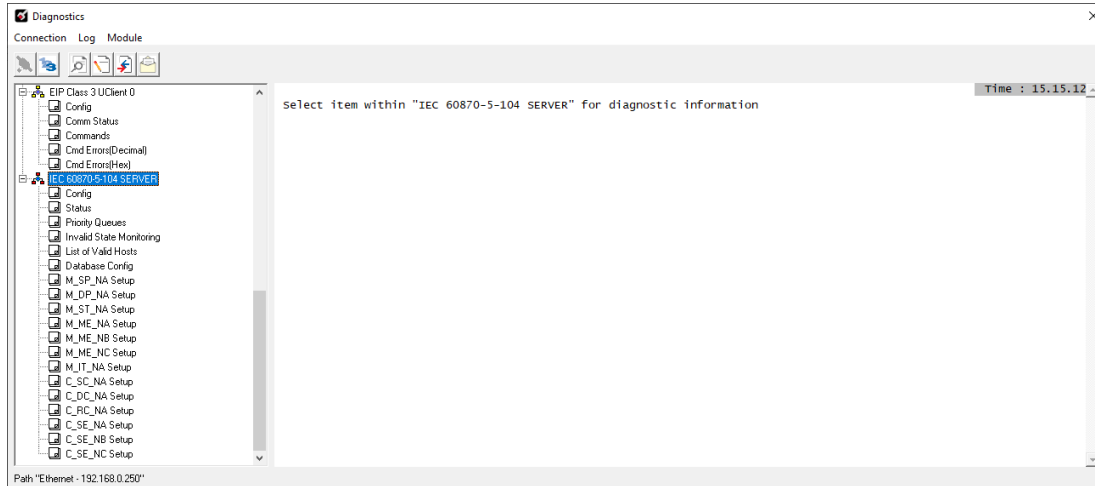

IEC-870-5-104 Configuration Menu

From the IEC 60870-5-104 Server Menu, click on the *Config* icon to open the IEC-870-5-104 Configuration Menu. This menu shows the gateway parameters in the configuration file.

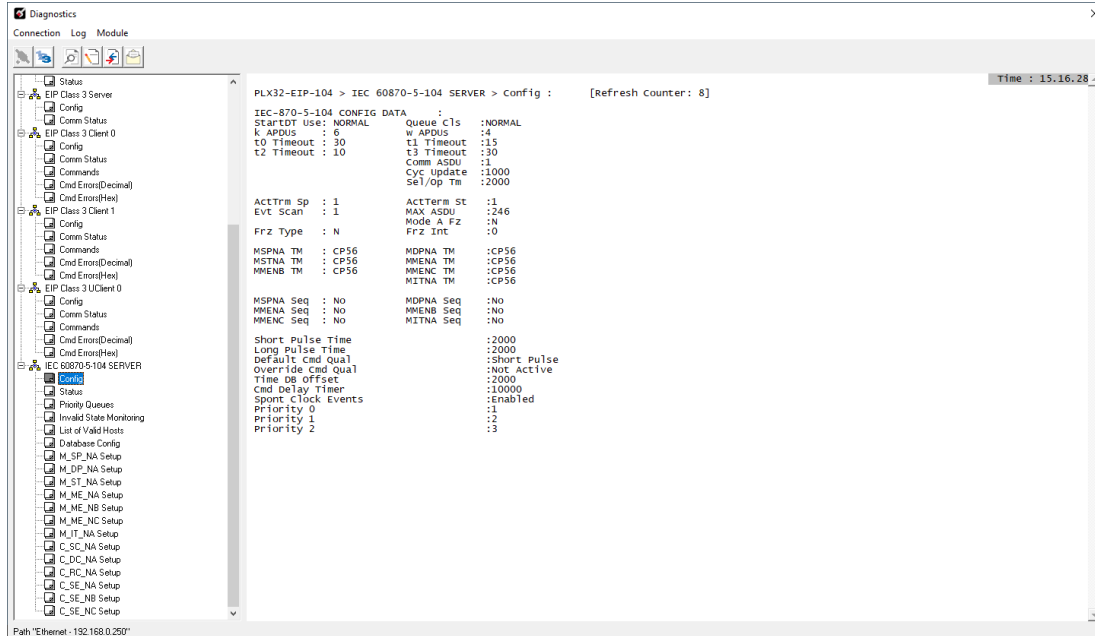

IEC-870-5-104 Status Data

From the IEC-870-5-104 Server Menu, click on the *Server x Status* icon to open the IEC-870-5-104 Status Data screen. Refer to the *Server Error and Status Data* section for more information about these values.

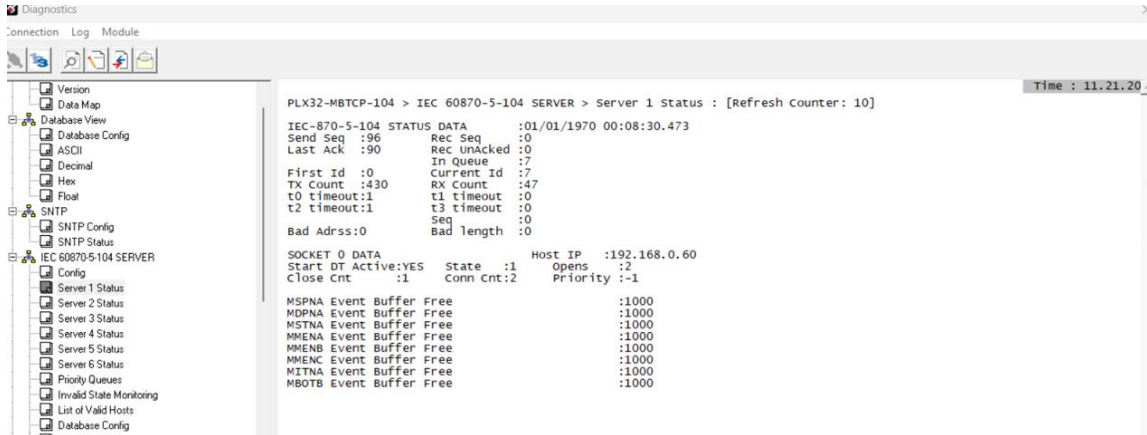

Lists of Valid Hosts

From the IEC 60870-5-104 Server Menu, click on the *List of Valid Hosts* icon. These values are taken from the configuration file. The IP addresses will be displayed only if the *Use IP List* parameter is set to **YES**.

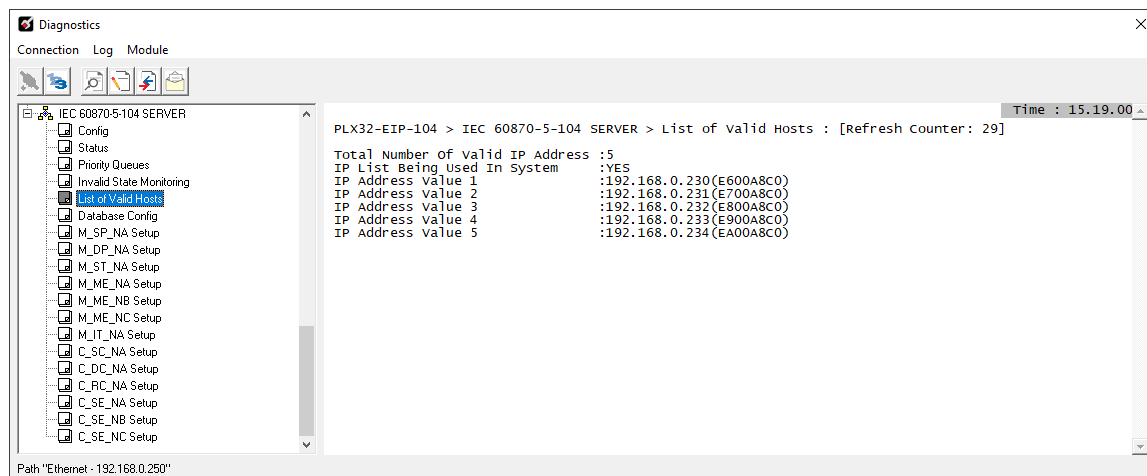

Point Setup

From the IEC 60870-5-104 Server Menu, click on the *Setup* icon for each data type. The information includes point address, group and its current value.

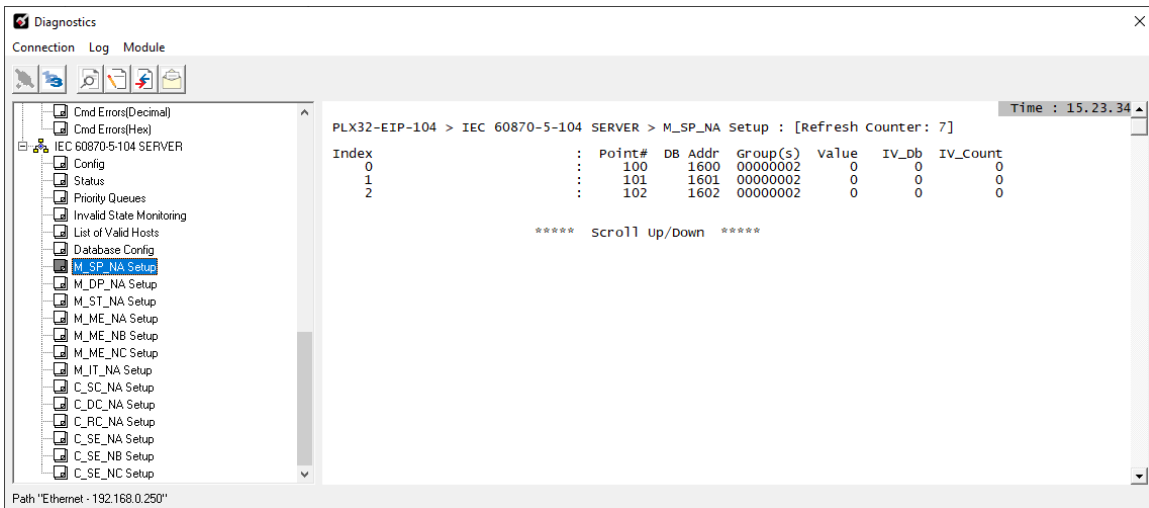

Database Configuration

From the IEC-870-5-104 Server Menu, click on the *Database Config* icon to display the number of configured points and the event configuration for each data type:

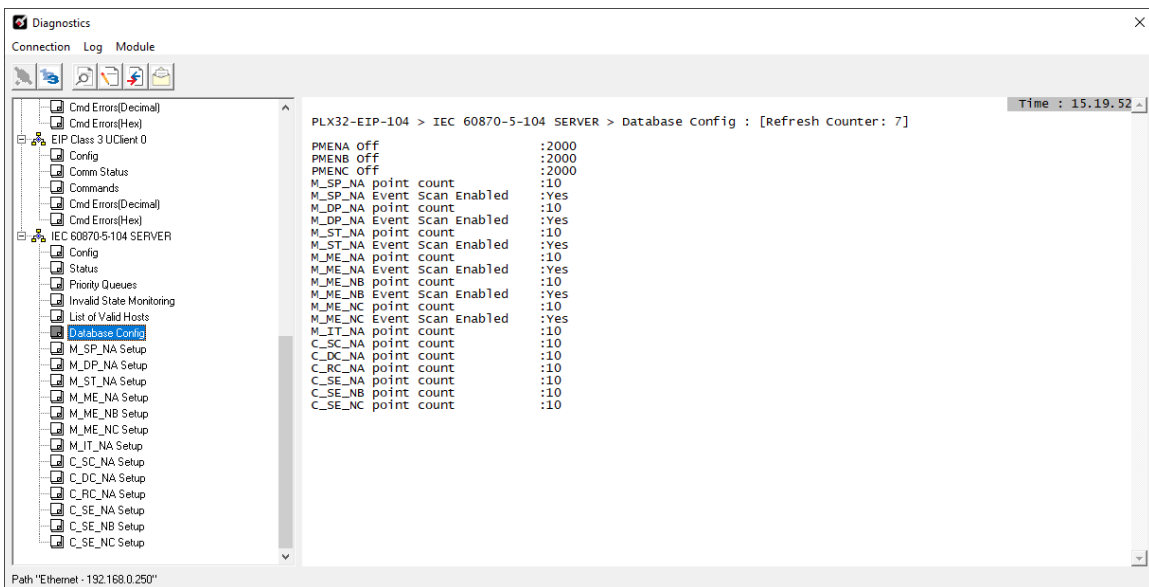

4.2 LED Indicators

Troubleshooting the operation of the PLX32 gateway 104 port can be performed using several methods. Information on the PLX32 gateway's other LEDs can be found in the PLX3x User Manual.

4.2.1 Status LEDs

LED	Status	Indication
CFG	Off	Normal Operation
	Solid Amber	The unit is in configuration mode. Either a configuration error exists, or the configuration file is being downloaded or read. After power-up, the gateway reads the configuration, and the unit implements the configuration values and initializes the hardware. This occurs during power cycle or after you press the Reset button
FLT	Off	Normal Operation
	Solid Red	A critical error has occurred. Program executable has failed or has been user-terminated and is no longer running. Press the Reset button or cycle power to clear the error.
PWR	Off	Power is not connected to the power terminals or source is insufficient to properly power the gateway (208 mA at 24 VDC is required).
	Solid Green	Power is connected to the power terminals
ERR	Off	Normal Operation
	Flashing Amber	An error condition has been detected and is occurring on one of the application ports. Check configuration and troubleshoot for communication errors.
	Solid Amber	This error flag is cleared at the start of each command attempt (master/client) or on each receipt of data (slave/adaptor/server). If this condition exists, it indicates a large number of errors are occurring in the application (due to bad configuration) or on one or more ports (network communication failures).

4.2.2 Ethernet Port LEDs

LED	Status	Indication
LINK/ACT	Off	No physical network connection is detected. No Ethernet communication is possible. Check wiring and cables.
	Solid Green	Physical network connection detected. This LED must be ON solid for Ethernet communications to occur.
10/100 Mbit	Off	No activity on the port.
	Flashing Amber	The Ethernet port is actively transmitting or receiving data.

4.2.3 PLX32-EIP-104 (only) LEDs

LED	Status	Indication
NS (Network Status)	Off	No power or no IP address
	Solid Red	Duplicate IP address
	Solid Green	Connected
	Flashing Red	Connection timeout
	Flashing Green	IP address obtained; no established connections
	Alternating Red and Green flash	Self-test
MS (Module Status)	Off	No power
	Solid Red	Major fault
	Solid Green	Device operational
	Flashing Red	Minor fault
	Flashing Green	Standby
	Alternating Red and Green flash	Self-test

5 Reference

5.1 Command Block Functionality

5.1.1 Introduction

The command block functionality allows the gateway to receive requests for special tasks through the other protocol channel (example: Modbus TCP/IP or EtherNet/IP). To perform a command block request, a command block must be moved to the PLX32 gateway database starting at a specific address configured by the user. For example, this functionality allows a Modbus TCP/IP client to pass IEC-870-5-104 timestamp events to the IEC-870-5-104 client that is connected to the PLX32 gateway:

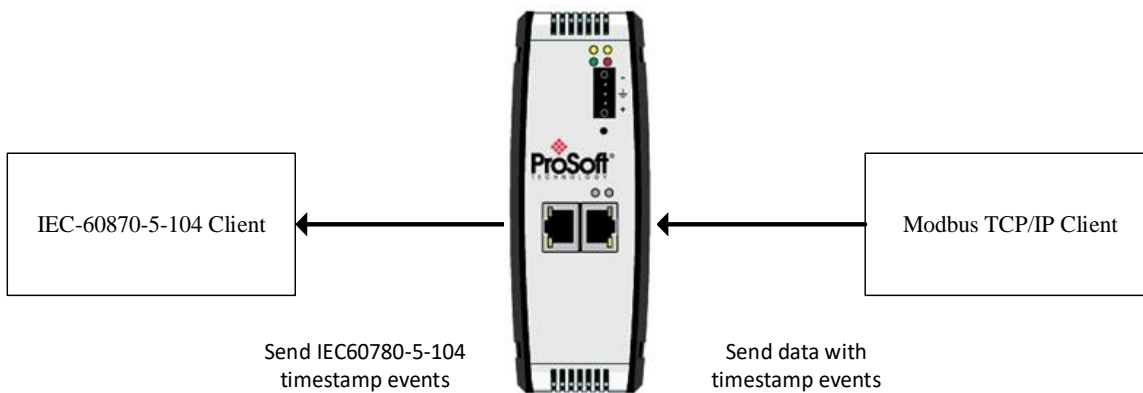

5.1.2 Configuration

In order to configure the PLX32 gateway to use the mailbox functionality, there are two parameters to be configured:

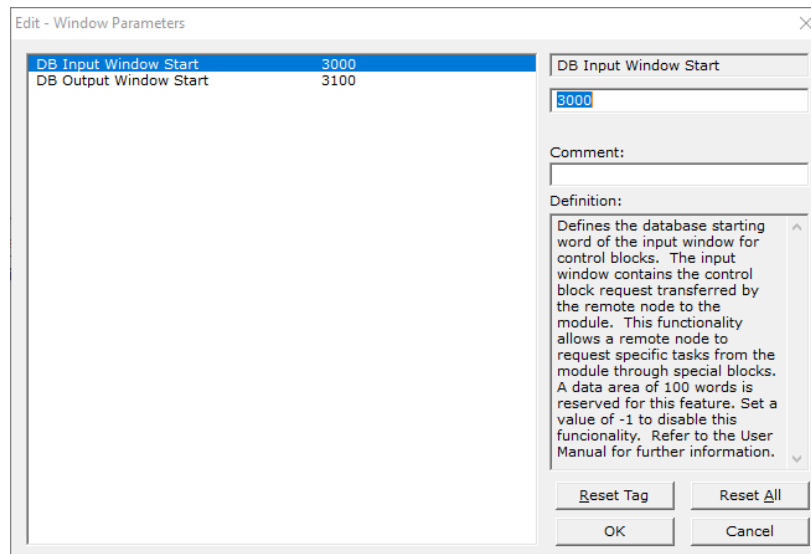

The *DB Input Window Start* parameter defines the PLX32 gateway database starting register where the command block request should be transferred to (from the remote node to the PLX32 gateway). For the example above, a Modbus TCP/IP client would send a control block request to the PLX32 gateway starting at database start register 3000. A value of -1 disables this functionality.

The *DB Output Window Start* parameter defines the PLX32 gateway database starting register where the control block response should be transferred to (from the PLX32 gateway to the remote node). So some control blocks will require a response from the gateway (for example the control block to retrieve the current time from the gateway). For the example above, the remote node must read the control block response from the PLX32 gateway starting at database start register 3100. A value of -1 disables this functionality.

General Command Block Structure

A command request block will have the following general structure. The command request block should be copied starting at the database address given by the configuration parameter *DB Input Window Start*:

Word Offset	Description
0	Block ID1 - Command Request Without Response
1	Block ID2 - Command Request With Response
2 to 98	Command Request Data
99	Block ID1 - Command Request Without Response

Where:

- Command Request Without Response Block is transferred from the remote node to the PLX32 gateway to request a special task that does not require data back from the gateway. For example, a Set Time command block sets the gateway time but does not require data back from the gateway.
- Command Request With Response Block requires data back from the gateway. The response block is copied at a different database area. For example, a Get Time command block requests the gateway time information.

A command block may:

- Perform command request without response only
- Perform command request with response only
- Perform both command request with response and command request without response

The PLX32 gateway recognizes a new block command request if:

- A new command request block ID is received at word offsets 0 and 99
- The same command request block ID is received at word offsets 0 and 99

If these conditions are fulfilled the gateway will process the request and response command blocks.

Once the command response block is processed, the response data will be copied to the PLX32 gateway database with the following structure. The command response block will be copied starting at the database address given by the configuration parameter DB Output Window Start:

Word Offset	Description
0	Block ID2 - Command Request With Response
1	Block ID1 - Command Request Without Response
2 to 98	Command Response Data
99	Block ID2 - Command Request With Response

The remote node must therefore read this block from the PLX32 gateway to retrieve the command block response.

5.1.3 Command Block List

The following command blocks are supported by the gateway:

Block Range	Mode	Direction	Description
100 and 101	Command Request without Response	Node to PLX32 gateway	Event Data
200 and 201	Command Request without Response	Node to PLX32 gateway	Set Time
200 and 201	Command Request with Response	PLX32 gateway to Node	Get Time
202 and 203	Command Request with Response	PLX32 gateway to Node	Get Event Buffer Counts

Two block IDs per command type are required to allow the detection of a new block. So the remote node can switch between two block IDs when a new command block for the same type is requested. Even if the block only contains a request with response type, then offsets 0 and 99 must also trigger to a new value to allow the gateway to detect a new block. Follows below some examples to illustrate this functionality. This section will not cover each block structure but will only cover the block transfer mechanism. For these examples consider the default configuration settings:

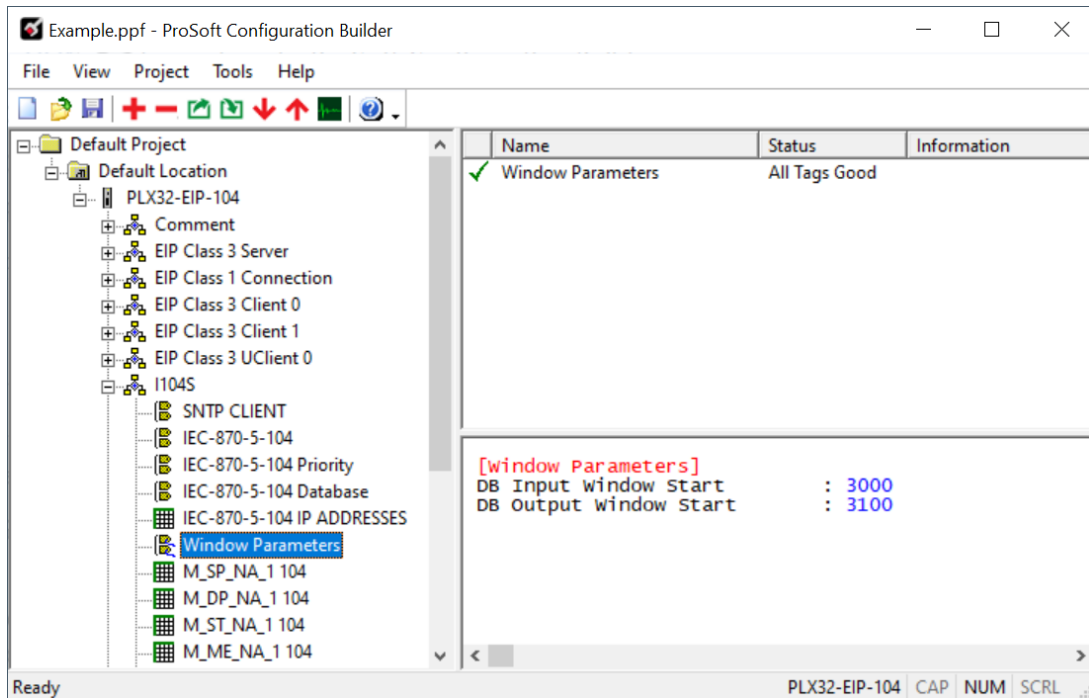

Example 1 - Command Request Without Response only

For this example, the remote node is passing a timestamp event to be transferred to the remote client connected to the PLX32 gateway.

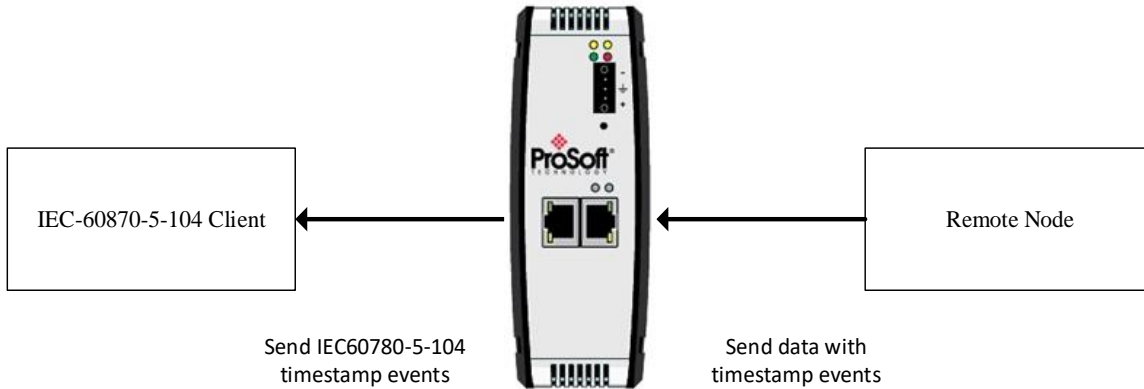

The following block can be used for the first request.

Command Request Block

Word Offset	Database Address	Value	Description
0	3000	100	Block ID1 - Command Request Without Response
1	3001	0	Block ID2 - Command Request With Response. Move a value of 0 or any other value out of the 200 to 203 range since no data is requested back from the gateway
2 to 10	3002 to 3010	Event Data	Timestamp event
99	3099	100	Block ID1 - Command Request Without Response

Command Response Block

Word Offset	Database Address	Value	Description
0	3100	0	Block ID2 - Command Request With Response.
1	3101	100	Block ID1 - Command Request Without Response
2 to 98	3102 to 3198	Reserved	Reserved - No update
99	3199	0	Block ID2 - Command Request With Response.

To send another command request to pass another event, use the following format:

Command Request Block

Word Offset	Database Address	Value	Description
0	3000	101	Block ID1 - Command Request Without Response
1	3001	0	Block ID2 - Command Request With Response. Move a value of 0 or any other value out of the 200 to 203 range since no data is requested back from the gateway
2 to 10	3002 to 3010	Event Data	Timestamp event
99	3099	101	Block ID1 - Command Request Without Response

Command Response Block

Word Offset	Database Address	Value	Description
0	3100	0	Block ID2 - Command Request With Response.
1	3101	101	Block ID1 - Command Request Without Response
2 to 98	3102 to 3198	Reserved	Reserved - no update
99	3199	0	Block ID2 - Command Request With Response.

Example 2 - Command Request with Response Only

For this example, the remote node is requesting the event buffer sizes from the PLX32 gateway. This is an example of a request that requires a response back from the gateway:

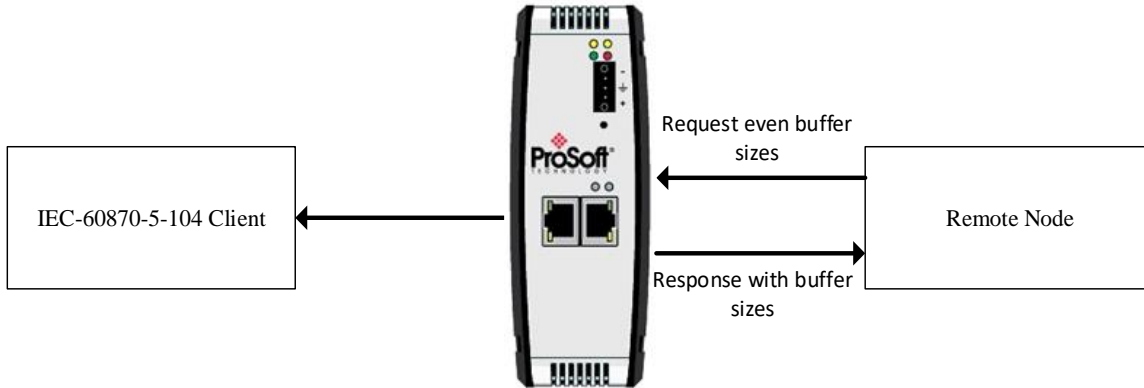

The following block can be used for the first request.

Command Request Block

Word Offset	Database Address	Value	Description
0	3000	0	Block ID1 - Command Request Without Response Move a value of 0 or any other value out of the 100 to 101 and 200 to 201 range, because no request without response is performed.
1	3001	202	Block ID2 - Command Request With Response.
2 to 98	3002 to 3098	Not Used	Not Used
99	3099	0	Block ID1 - Command Request Without Response Move a value of 0 or any other value out of the 100 to 101 and 200 to 201 range, because no request without response is performed.

Command Response Block

Word Offset	Database Address	Value	Description
0	3100	202	Block ID2 - Command Request With Response.
1	3101	0	Block ID1 - Command Request Without Response
2 to 8	3102 to 3108	Event Buffers	Event Buffers
99	3199	202	Block ID2 - Command Request With Response.

To send another command request to pass another event, use the following format:

Command Request Block

Word Offset	Database Address	Value	Description
0	3000	1	Block ID1 - Command Request Without Response Command Request Without Response Move a value of 0 or any other value out of the 100 to 101 and 200 to 201 range, because no request without response is performed.
1	3001	203	Block ID2 - Command Request With Response.
2 to 98	3002 to 3098	Not Used	Not Used
99	3099	1	Block ID1 - Command Request Without Response Command Request Without Response Move a value of 0 or any other value out of the 100 to 101 and 200 to 201 range, because no request without response is performed.

Command Response Block

Word Offset	Database Address	Value	Description
0	3100	203	Block ID2 - Command Request With Response.
1	3101	1	Block ID1 - Command Request Without Response
2 to 8	3102 to 3108	Event Buffers	Event Buffers
99	3199	203	Block ID2 - Command Request With Response.

Example 3 - Command Request with Response and Command Request Without Response

For this example, the remote node is setting the PLX32 gateway time and at the same time requesting the current time from the gateway.

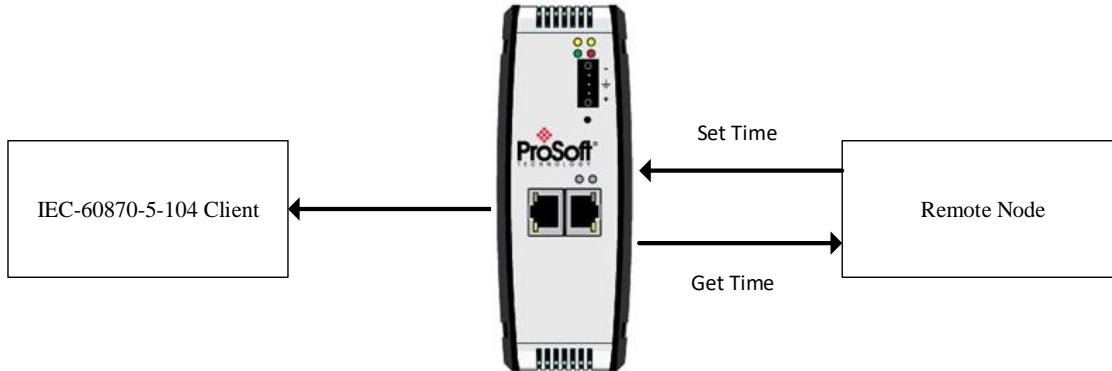

The following block can be used for the first request.

Command Request Block

Word Offset	Database Address	Value	Description
0	3000	200	Block ID1 - Command Request Without Response (Set Time)
1	3001	200	Block ID2 - Command Request With Response (Get Time)
2 to 8	3002 to 3008	New Time Sent to PLX32 gateway	New Time Sent to PLX32 gateway
99	3099	200	Block ID1 - (Set Time)

Command Response Block

Word Offset	Database Address	Value	Description
0	3100	200	Block ID2 - Command Request With Response (Get Time)
1	3101	200	Block ID1 - Command Request Without Response (Set Time)
2 to 8	3002 to 3008	Current Time sent by PLX32 gateway	Current Time sent by PLX32 gateway
99	3199	200	Block ID2 - Command Request With Response (Get Time)

To send another command request to pass another event, use the following format:

Command Request Block

Word Offset	Database Address	Value	Description
0	3000	201	Block ID1 - Command Request Without Response (Set Time)
1	3001	201	Block ID2 - Command Request With Response (Get Time)
2 to 98	3002 to 3008	New Time Sent to PLX32 gateway	New Time Sent to PLX32 gateway
99	3099	201	Block ID1 - (Set Time)

Command Response Block

Word Offset	Database Address	Value	Description
0	3100	201	Block ID2 - Command Request With Response (Get Time)
1	3101	201	Block ID1 - Command Request Without Response (Set Time)
2 to 8	3102 to 3108	Event Buffers	Current Time sent by PLX32 gateway
99	3199	201	Block ID2 - Command Request With Response (Get Time)

The following sections describe the detailed structure of each command block.

5.1.4 Event Data Command Block

This functionality allows a remote node to pass timestamp events to be transferred to the IEC-870-5-104 client connected to the PLX32 gateway. The following tables describe structure of the event data command block.

Note: The gateway supports a buffer queue of 1000 events per data type. When the queue is full, the module will delete the older event in the queue if a new event is received.

Note: Firmware versions prior to PLX32-EIP-104 v1.006.012 and PLX32-MBTCP-104 v1.005.028 support a buffer queue of 99 events per data type.

Request Block

Each Event Request block can send up to 10 events to the gateway. Refer to Events (page 73) for more information about timestamped events. This block should only be used to pass events with a predefined timestamp (the gateway will also send timestamped events when database values change). While using the Event Request block, disable the events for those specific points (page 49) to avoid multiple event generation (caused by point value update through the database).

Start Word	End Word	Data Field(s)	Description
0	0	Block ID	100 or 101 = Set Time (Block ID1)
1	1	Data block being requested	Block ID2 (Command Request With Response)
2	2	Event Count	Number of events present in the block. This field can have a value from 1 to 12.
3	10	Event #1	Event data to add to event message queue.
11	18	Event #2	Event data to add to event message queue.
19	26	Event #3	Event data to add to event message queue.
27	34	Event #4	Event data to add to event message queue.
35	42	Event #5	Event data to add to event message queue.
43	50	Event #6	Event data to add to event message queue.
51	58	Event #7	Event data to add to event message queue.
59	66	Event #8	Event data to add to event message queue.
67	74	Event #9	Event data to add to event message queue.
75	82	Event #10	Event data to add to event message queue.
83	90	Event #11	Event data to add to event message queue.
91	98	Event #12	Event data to add to event message queue.
99	99	Block ID	100 or 101 = Set Time (Block ID1)

Each event contains the following data structure:

Start Byte	End Byte	Data Field(s)	Description
0	1	DB Index	This is the index for the point in the gateway's database. This corresponds to the order of point definition for the gateway data types. This is not the point address for the event.
2	2	ASDU	This is the ASDU data type for the event message. <ul style="list-style-type: none"> • 1 = Single point • 3 = Double-point • 5 = Step • 9 = Normalized • 11 = Scaled • 13 = Short-float • 15 = Integrated total
3	3	Qualifier	This is the qualifier code for the event message. Refer to the IEC protocol specification for a full listing of valid qualifier codes for each ASDU type.
4	5	Year	This field contains the four-digit year for the event.
6	6	Month	This field contains the month value for the event. Valid entry for this field is in the range of 1 to 12.
7	7	Day	This field contains the day value for the event. Valid entry for this field is in the range of 1 to 31.
8	8	Hour	This field contains the hour value for the event. Valid entry for this field is in the range of 0 to 23 (bits 0 to 4). Bit 7 of the byte can be used to set the summertime flag (0=standard, 1=summer time)
9	9	Minute	This field contains the minute value for the event. Valid entry for this field is in the range of 0 to 59 (bits 0 to 5). Bit 7 of the byte can be used to set the invalid bit for the time (0=valid, 1=invalid).
10	11	Seconds & Milliseconds	This field contains the seconds and milliseconds value for the event. Valid entry for this field is in the range of 0 to 59,999.
12	15	Data	These bytes contain the data for the event. For single- and double-point, step events, the first byte is used. For measured value events, the first two bytes are used. For integrated total and short-float events, all four bytes are used.

5.1.5 Set Time Command Block

This functionality allows a remote node to set the clock of the PLX32 gateway.

Request Block

The following table describes the structure of the Set Time command block.

Start Word	End Word	Description
0	0	200 or 201 = Set Time (Block ID1)
1	1	Block ID2 (Command Request With Response)
2	2	Year
3	3	Month
4	4	Day
5	5	Hour
6	6	Minutes
7	7	Seconds & milliseconds
8	98	Reserved for future use
99	99	200 or 201 = Set Time (Block ID1)

5.1.6 Get Time Command Block

This functionality allows a remote node to retrieve the clock data from the PLX32 gateway.

Request Block

The following table describes the structure of the Get Time command block.

Start Word	End Word	Description
0	0	Block ID1 (Command Request Without Response)
1	1	200 or 201 = Get Time (Block ID2)
2	2	Year
3	3	Month
4	4	Day
5	5	Hour
6	6	Minutes
7	7	Seconds & milliseconds
8	98	Reserved for future use
99	99	Block ID1 (Command Request Without Response)

Response Block

Start Word	End Word	Description
0	0	200 or 201 = Get Time (Block ID2)
1	1	Block ID1 (Command Request Without Response)
2	2	Year
3	3	Month
4	4	Day
5	5	Hour
6	6	Minutes
7	7	Seconds & milliseconds
8	98	Reserved for future use
99	99	200 or 201 = Get Time (Block ID2)

5.1.7 Get Event Buffer Sizes Command Block

This functionality allows a remote node to retrieve the event buffer space of each data type. The following tables describe the structure of the Get Event Buffer Sizes command block:

Request Block

Start Word	End Word	Description
0	0	Block ID1 (Command Request Without Response)
1	1	202 or 203 = Get Event Buffer Count (Block ID2)
2	2	Reserved
3	98	Reserved
99	99	Block ID1

Response Block

Start Word	End Word	Description
0	0	202 or 203 = Get Event Buffer Count (Block ID2)
1	1	Block ID1 (Command Request Without Response)
2	2	Single point event buffer space
3	3	Double point event buffer space
4	4	Step point event buffer space
5	5	Normalized event buffer space
6	6	Scaled event buffer space
7	7	Short-float event buffer space
8	8	Integrated totals event buffer space
9	98	Reserved
99	99	202 or 203 = Get Event Buffer Count (Block ID2)

5.2 SNTP Status Data

The status data for the SNTP driver is located at the virtual database addresses shown in the following table. The data area is initialized with zeros whenever the gateway is initialized. This occurs during a cold-start (power-on), reset (reset push-button pressed) or warm-boot operation (commanded or loading of new configuration).

SNTP Client Status	Description
14030	Time is valid
14031	Request count
14032	Response count
14033	Computation count
14034	Clock set count
14035	Timeout error count

The gateway's data mapping feature can be utilized to move this data into the gateway's database area. This way the data can be made available to all drivers on the gateway for use on any of the connected networks. If it is not mapped into the gateway's database, the data will only be available through the Configuration/Debug Port.

The Time is Valid status register will be set to 1 if the SNTP time is valid. If the time is not valid, the register will be set to 0. All the other registers are counters used to determine the functionality of the driver.

This version of the driver supports SNTP Revision 3 and stratum between 1 and 14.

5.3 Server Error and Status Data

The Server Error and Status Data areas represent a collection of status, diagnostic and troubleshooting registers which may prove helpful in troubleshooting the 104S network and port operation. The data map functionality of the gateway must be utilized to map this data into the application gateway database area (memory word addresses 0 to 9999). All or any portion of the data can be moved using the Data Map.

The data area is initialized with zeros whenever the gateway is initialized. This occurs during a cold-start (power-on), reset (reset push-button pressed) or a warm-boot operation (commanded or loading of new configuration).

Status Register	Name	Description
N/A	Send Seq	The data send sequence number.
N/A	Last Ack	The last acknowledgement of the send sequence number.
N/A	Rec Seq	The data received sequence number.
N/A	Rec UnAcked	The data which has been received but is not acknowledged.
N/A	In Queue	The data which has been sent but is present in queue and acknowledgement has not been received.
N/A	First Id	The first Id of Queue buffer.
N/A	Current Id	The sequence number of the queue Id.
N/A	TX Count	The total number of times data has been transmitted.
N/A	Rx Count	The total number of times data has been received.
20200	t0 Timeout Count	Contains the number of t0 errors recognized by the gateway.
20201	t1 Timeout Count	Contains the number of t1 errors recognized by the gateway.
20202	t2 Timeout Count	Contains the number of t2 errors recognized by the gateway.
20203	t3 Timeout Count	Contains the number of t3 errors recognized by the gateway.
20204	Sequence Error Count	Contains the number of sequence errors recognized by the gateway. When the send sequence number received by the PLX32 gateway does not match the expected sequence number, the connection is closed and this counter is incremented.
20205	Bad Address Error Count	Contains the number of messages received from the remote host that do not contain a valid common ASDU address in the packet.
20206	Length Error Count	Contains the number of messages received from the remote host that do not have a valid length field.
20207	Receive Frame Count	Contains the number of message frames (not packets) received from the host. A packet may contain more than one message.
20208	Transmit Frame Count	Contains the number of message frames sent to the host from the unit.
20209	Socket State Value (socket 0)	Contains the current socket state as follows: -1 = Open Socket 0 = Wait for connection 1 = Transmit message if ready 2 = Receive packet and process message

Status Register	Name	Description
		3 = Process multiple messages in packet 50 = Send TestFr Act 51 = Wait for TestFr Con 60 = Send sequence (S-Format) message 1000 = Close Socket 1001 = Wait for socket to close
20210	Socket Open Count (socket 0)	Contains the number of times the socket listen function executed.
20211	Socket Close Count (socket 0)	Contains the number of times an active close function executed.
20212	Socket Connect Count (socket 0)	Contains the number of times a connection was established with the remote host unit.
20213	Host IP Address (socket 0)	IP address of the client connected to the server.
20223	StartDT active (socket 0)	Contains the current StartDT state as follows: 0 = The gateway has not received the most recent STARTDT request through this socket or there has been no communication with the remote host unit. 1 = The gateway has received the most recent STARTDT request through this socket (therefore will be reporting data to the remote client connected through this socket),
20250	Socket State Value (socket 1)	Contains the current socket state as follows: -1 = Open Socket 0 = Wait for connection 1 = Transmit message if ready 2 = Receive packet and process message 3 = Process multiple messages in packet 50 = Send TestFr Act 51 = Wait for TestFr Con 60 = Send sequence (S-Format) message 1000 = Close Socket 1001 = Wait for socket to close
20251	Socket Open Count (socket 1)	Contains the number of times the socket listen function executed.
20252	Socket Close Count (socket 1)	Contains the number of times an active close function executed.
20253	Socket Connect Count (socket 1)	Contains the number of times a connection was established with the remote host.
20254	Host IP Address (socket 1)	IP address of the client connected to the server.
20264	StartDT active (socket 1)	Contains the current StartDT state as follows: 0 = The gateway has not received the most recent STARTDT request through this socket or there has been no communication with the remote host unit. 1 = The gateway has received the most recent STARTDT request through this socket (it will be reporting data to the remote client connected through this socket).
20265 to 20279		Socket 2 error and status data
20280 to 20294		Socket 3 error and status data
20295 to 20309		Socket 4 error and status data
20310 to 20324		Socket 5 error and status data

5.4 Command Qualifiers

Qualifier Code	Description
0	No additional definitions (Module will use Long duration pulse for this qualifier selection).
1	Short pulse duration (circuit breaker), determined by user-set parameter in gateway. This is supported in the gateway for single and dual point commands.
2	Long duration pulse (control relay), duration determined by user-set parameter in gateway. This is supported in the gateway for single and dual point commands.
3	Persistent output of control. This is supported in the gateway for all output data types.
4 to 8	Reserved for standard definitions of standard - NOT SUPPORTED
9 to 15	Reserved for the selection of other predefined functions - NOT SUPPORTED
16 to 31	Reserved for special use (private range) - NOT SUPPORTED

5.5 Parameter Qualifiers

Parameter	Description
0	Not used.
1	Threshold value (deadband). This parameter is used as the value of variation from the last reported event value to generate events. Each measured value has a user-assigned deadband value. The low and high limit parameter values are computed using the value entered for each measure data point. This parameter can be set and read by the controlling device (client).
2	Smoothing factor (filtered time constant) - NOT SUPPORTED
3	Low limit for transmission of metered values. This value is used as the lower limit for event generation. The value of this parameter is determined based on the value of the last reported event and the deadband set for the specific point. This parameter can be read by the controlling device (client).
4	High limit for transmission of measured values. This value is used as the upper limit for event generation. The value of this parameter is set based on the value of the last reported event and the deadband for the specific point. This parameter can be read by the controlling device (client).
5 to 31	Reserved for standard definitions of standard - NOT SUPPORTED
32 to 63	Reserved for special use - NOT SUPPORTED.

5.6 IEC 60870-5-104 Server Interoperability Document

This companion standard presents sets of parameters and alternatives from which subsets have to be selected to implement particular telecontrol systems. Certain parameter values, such as the number of octets in the COMMON ADDRESS of ASDUs represent mutually exclusive alternatives. This means that only one value of the defined parameters is admitted per system. Other parameters, such as the listed set of different process information in command and in monitor direction allow the specification of the complete set or subsets, as appropriate for given applications. This clause summarizes the parameters of the previous clauses to facilitate a suitable selection for a specific application. If a system is composed of equipment stemming from different manufacturers it is necessary that all partners agree on the selected parameters.

Note: The full specification of a system may require individual selection of certain parameters for certain parts of the system, such as the individual selection of scaling factors for individually addressable measured values.

The selected parameters should be marked in the white boxes as follows:

- D Function or ASDU is not used
- Function or ASDU is used as standardized (default)
- R Function or ASDU is used in reverse mode
- B Function or ASDU is used in standard and reverse mode

The possible selection (blank, X, R, B) is specified for each specific clause or parameter.

A black check box indicates that the option cannot be selected in this companion standard.

5.6.1 System or device

- D System definition
- D Controlling station definition (Master)
- Controlled station definition (Slave)

5.6.2 Application Layer

Transmission mode for application data

Mode 1 (Least significant octet first), as defined in clause 4.10 of IEC 60870-5-4, is used exclusively in this companion standard.

Common Address of ASDU (System-specific parameter)

D One octet Two octets

Information object address (System-specific parameter)

D One octet D Structured
D Two octets D Unstructured
 Three octets

Cause of transmission (System-specific parameter)

D One octet Two octets (with originator address)

Length of APDU (System-specific parameter)

Specify the maximum length of the APDU per system.

The Maximum length of the APDU is 246 (default). The maximum length may be reduced by the system.

246 Maximum length of APDU per system

5.6.3 Selection of standard ASDUs

Process information in monitor direction (Station-specific parameter)

Mark each Type ID "X" if it is only used in the standard direction, "R" if only used in the reverse direction, and "B" if used in both directions.

☒	<1>	:= Single-point information	M_SP_NA_1
☒	<3>	:= Double-point information	M_DP_NA_1
☒	<5>	:= Step position information	M_ST_NA_1
D	<7>	:= Bit-string of 32 bit	M_BO_NA_1
☒	<9>	:= Measured value, normalized value	M_ME_NA_1
☒	<11>	:= Measured value, scaled value	M_ME_NB_1
☒	<13>	:= Measured value, short floating point value	M_ME_NC_I
☒	<15>	:= Integrated totals	M_IT_NA_1
D	<20>	:= Packed single-point information with status change detection	M_PS_NA_1
D	<21>	:= Measured value, normalized value without quality descriptor	M_ME_ND_1
☒	<30>	:= Single-point information with time tag CP56Time2a	M_SP_TB_1
☒	<31>	:= Double-point information with time tag CP56Time2A	M_DP_TB_1
☒	<32>	:= Step position information with time tag CP56Time2A	M_ST_TB_1
☒	<33>	:= Bit-string of 32 bit with time tag CP56Time2A Note: This applies only to the PLX32-MBTCP-104 v1.005.019 and newer, using PCB v4.8.0.018 and newer.	M_BO_TB_1
☒	<34>	:= Measured value, normalized value with time tag CP56Time2A	M_ME_TD_1
☒	<35>	:= Measured value, scaled value with time tag CP56Time2A	M_ME_TE_1
☒	<36>	:= Measured value, short floating point value with time tag CP56Time2A	M_ME_TF_1
☒	<37>	:= Integrated totals with time tag CP56Time2A	M_IT_TB_1
D	<38>	:= Event of protection equipment with time tag CP56Time2A	M_EP_TD_1
D	<39>	:= Packed start events of protection equipment with time tag CP56time2A	M_EP_TE_1
D	<40>	:= Packed output circuit information of protection equipment with time tag CP56Time2a	M_EP_TF_1

Process information in control direction

(Station-specific parameter, mark each Type ID 'X' if it is only used in the standard direction, "R" if only used in the reverse direction, and "B" if used in both directions)

<input checked="" type="checkbox"/>	<45>	:= Single command	C_SC_NA_1
<input checked="" type="checkbox"/>	<46>	:= Double command	C_DC_NA_1
<input checked="" type="checkbox"/>	<47>	:= Regulating step command	C_RC_NA_1
<input checked="" type="checkbox"/>	<48>	:= Set point command, normalized value	C_SE_NA_1
<input checked="" type="checkbox"/>	<49>	:= Set point command, scaled value	C_SE_NB_1
<input checked="" type="checkbox"/>	<50>	:= Set point command, short floating point value	C_SE_NC_1
D	<51>	:= Bit-string of 32 bit	C_BO_NA_1
<input checked="" type="checkbox"/>	<58>	:= Single command with time tag CP56Time2a	C_SC_TA_1
<input checked="" type="checkbox"/>	<59>	:= Double command with time tag CP56Time2A	C_DC_TA_1
<input checked="" type="checkbox"/>	<60>	:= Regulating step command with time tag CP56Time2A	C_RC_TA_1
<input checked="" type="checkbox"/>	<61>	:= Set point command, normalized value with time tag CP56Time2A	C_SE_TA_1
<input checked="" type="checkbox"/>	<62>	:= Set point command, scaled value with time tag CP56Time2A	C_SE_TB_1
<input checked="" type="checkbox"/>	<63>	:= Set point command, short float value with time tag CP56Time2A	C_SE_TC_1
D	<64>	:= Bit-string of 32 bit with time tag CP56Time2A	C_BO_TA_1

Either the ASDUs of the set <45>-<51> or of the set <58>-<64> are used.

System information in monitor direction

(Station-specific parameter, mark "X" if used)

<input checked="" type="checkbox"/>	<70>	:= End of initialization	M_EI_NA_1
-------------------------------------	------	--------------------------	-----------

System information in control direction

(Station-specific parameter, mark each Type ID 'X' if it is only used in the standard direction, "R" if only used in the reverse direction, and "B" if used in both directions)

<input checked="" type="checkbox"/>	<100>	:= Interrogation command	C_IC_NA_1
<input checked="" type="checkbox"/>	<101>	:= Counter interrogation command	C_CI_NA_1
<input checked="" type="checkbox"/>	<102>	:= Read command	C_RD_NA_1
<input checked="" type="checkbox"/>	<103>	:= Clock synchronization command	C_CS_NA_1
<input checked="" type="checkbox"/>	<105>	:= Reset process command	C_RP_NC_1
<input checked="" type="checkbox"/>	<107>	:= Test command with time tag CP56Time2a	C_TS_TA_1

Parameter in control direction

(Station-specific parameter, mark each Type ID 'X' if it is only used in the standard direction, "R" if only used in the reverse direction, and "B" if used in both directions)

☒	<110>	:= Parameter of measured value, normalized value	P_ME_NA_1
☒	<111>	:= Parameter of measured value, scaled value	P_ME_NB_1
☒	<112>	:= Parameter of measured value, short floating point value	P_ME_NC_1
D	<113>	:= Parameter activation	P_AC_NA_1

File transfer

(Station-specific parameter, mark each Type ID "X" if it is only used in the standard direction, "R" if only used in the reverse direction, and "B" if used in both directions)

D	<120>	:= File ready	F_FR_NA_1
D	<121>	:= Section ready	F_SR_NA_1
D	<122>	:= Call directory, select file, call file, call section	F_SC_NA_1
D	<123>	:= Last section, last segment	F_LS_NA_1
D	<124>	:= Ack file, ack section	F_AF_NA_1
D	<125>	:= Segment	F_SG_NA_1
D	<126>	:= Directory	F_DR_TA_1

5.6.4 Type identifier and cause of transmission assignments

(Station-specific parameters)

Black boxes: Option not permitted in this companion standard

Blank boxes: Functions or ASDU not used

Mark Type Identification/Cause of Transmission combinations:

"X" if only used in standard direction.

"R" if only used in reverse direction.

"B" if used in both directions.

Type Identification		Cause of transmission																							
		1	2	3	4	5	6	7	8	9	10	11	12	13	20 to 36	37 to 41	44	45	46	47					
<1>	M SP NA 1	X	X	X							X			X											
<3>	M DP NA 1	X	X	X							X			X											
<5>	M ST NA 1	X	X	X							X			X											
<7>	M BO NA 1																								
<9>	M ME NA 1	X	X	X										X											
<11>	M ME NB 1	X	X	X										X											
<13>	M ME NC 1																								
<15>	M IT NA 1	X	X	X												X									
<20>	M PS NA 1																								
<21>	M ME ND 1																								
<30>	M SP TB 1		X																						
<31>	M DP TB 1		X																						
<32>	M ST TB 1		X																						
<33>	M BO TB 1																								
<34>	M ME TD 1		X																						
<35>	M ME TE 1		X																						
<36>	M ME TF 1		X																						
<37>	M IT TB 1		X													X									
<38>	M EP TD 1																								
<39>	M EP TE 1																								
<40>	M EP TF 1																								
<45>	C SC NA 1						X	X	X	X	X														
<46>	C DC NA 1						X	X	X	X	X														
<47>	C RC NA 1						X	X	X	X	X														
<48>	C SE NA 1						X	X	X	X	X														
<49>	C SE NB 1						X	X	X	X	X														
<50>	C SE NC 1																								
<51>	C BO NA 1																								
<58>	C SC TA 1																								
<59>	C DC TA 1																								
<60>	C RC TA 1																								
<61>	C SE TA 1																								
<62>	C SE TB 1																								
<63>	C SE TC 1																								
<64>	C BO TA 1																								
<70>	M EI NA 1			X																					
<100>	C IC NA 1						X	X	X	X	X														
<101>	C CI NA 1						X	X			X														
<102>	C RD NA 1				X																				
<103>	C CS NA 1						X	X																	
<105>	C RP NA 1						X	X																	
<107>	C TS TA 1																								
<110>	P ME NA 1						X	X																	
<111>	P ME NB 1						X	X																	
<112>	P ME NC 1																								
<113>	P AC NA 1																								
<120>	F FR NA 1																								
<121>	F SR NA 1																								
<122>	F SC NA 1																								
<123>	F LS NA 1																								
<1124>	F AF NA 1																								
<125>	F SG NA 1																								
<126>	F DR TA 1																								

5.6.5 Basic Application Functions

Station initialization

(Station-specific parameter, mark "X" if function is used)

Remote initialization

Cyclic data transmission

(Station-specific parameter, mark "X" if function is only used in the standard direction, "R" if only used in the reverse direction, and "B" if used in both directions)

Cyclic data transmission

Read procedure

(Station-specific parameter, mark "X" if function is only used in the standard direction, "R" if only used in the reverse direction, and "B" if used in both directions)

Read procedure

Spontaneous transmission

(Station-specific parameter, mark "X" if function is only used in the standard direction, "R" if only used in the reverse direction, and "B" if used in both directions)

Spontaneous transmission

Double transmission of information objects with cause of transmission spontaneous

(Station-specific parameter, mark each information type "X" where both a Type ID without time and corresponding Type ID with time are issued in response to a single spontaneous change of a monitored object)

The following type identifications may be transmitted in succession caused by a single status change of an information object. The particular Information Object Addresses for which double transmission is enabled are defined in a project- specific list.

D Single-point information M_SP_NA_1, M_SP_TA_1, M_SP_TB_1 and M_PS_NA_1

D Double-point information M_DP_NA_1, MDP_TA_1 and M_DP_TB_1

D Step position information M_ST_NA_1, M_ST_TA_1 and M_ST_TB_1

D Bit-string of 32 bit M_BO_NA_1, M_BO_TA_1 and M_BO_TB_1

D Measured value, normalized value M_ME_NA_1, M_ME_TA_1, M_ME_ND_1

D Measured value, scaled value M_ME_NB_1, M_ME_TB_1 and M_ME_TE_1

D Measured value, short floating point number M_ME_NC_1, M_ME_TC_1 and M_ME_TF_1

Station Interrogation

(Station-specific parameter, mark "X" if function is only used in the standard direction, "R" if only used in the reverse direction, and "B" if used in both directions)

- | | | | |
|----------------------------------|--------------------------|----------|-----------------------------------|
| <input type="checkbox"/> global | | | |
| <input type="checkbox"/> group 1 | <input type="checkbox"/> | group 7 | <input type="checkbox"/> group 13 |
| <input type="checkbox"/> group 2 | <input type="checkbox"/> | group 8 | <input type="checkbox"/> group 14 |
| <input type="checkbox"/> group 3 | <input type="checkbox"/> | group 9 | <input type="checkbox"/> group 15 |
| <input type="checkbox"/> group 4 | <input type="checkbox"/> | group 10 | <input type="checkbox"/> group 16 |
| <input type="checkbox"/> group 5 | <input type="checkbox"/> | group 11 | |
| <input type="checkbox"/> group 6 | <input type="checkbox"/> | group 12 | |

Addresses per group must be defined.

Clock synchronization

(Station-specific parameter, mark "X" if function is only used in the standard direction, "R" if only used in the reverse direction, and "B" if used in both directions)

-
- | |
|---|
| <input type="checkbox"/> Clock synchronization optional |
|---|
-

Command transmission

(Object-specific parameter, mark "X" if function is only used in the standard direction, "R" if only used in the reverse direction, and "B" if used in both directions)

-
- | |
|---|
| <input type="checkbox"/> Direct command transmission |
| <input type="checkbox"/> Direct set point command transmission |
| <input type="checkbox"/> Select and execute command |
| <input type="checkbox"/> Select and execute set point command |
| <input type="checkbox"/> C_SE_ACTTERM used <small>note2</small> |
| <input type="checkbox"/> No additional definition |
| <input type="checkbox"/> Short pulse duration (duration determined by a system parameter in the outstation) |
| <input type="checkbox"/> Long pulse duration (duration determined by a system parameter in the outstation) |
| <input type="checkbox"/> Persistent output |
| D Supervision of maximum delay in command direction of commands and |
| D Maximum allowable delay of commands and set point commands |
-

Transmission of Integrated totals

(Station- or object-specific parameter, mark "X" if function is only used in the standard direction, "R" if only used in the reverse direction, and "B" if used in both directions)

<input type="checkbox"/>	Mode A: Local freeze with spontaneous transmission
D	Mode B: Local freeze with counter interrogation
D	Mode C: Freeze and transmit by counter-interrogation commands
<input type="checkbox"/>	Mode D: Freeze by counter-interrogation command, frozen values reported spontaneously
<input type="checkbox"/>	Counter read
<input type="checkbox"/>	Counter freeze without reset
D	Counter freeze with reset
D	Counter reset
<input type="checkbox"/>	General request counter
<input type="checkbox"/>	Request counter group 1
<input type="checkbox"/>	Request counter group 2
<input type="checkbox"/>	Request counter group 3
<input type="checkbox"/>	Request counter group 4

Parameter loading

(Object-specific parameter, mark "X" if function is only used in the standard direction, "R" if only used in the reverse direction, and "B" if used in both directions)

<input type="checkbox"/>	Threshold value
D	Smoothing factor
<input type="checkbox"/>	Low limit for transmission of measured value
<input type="checkbox"/>	High limit for transmission of measured value

Parameter activation

(Object-specific parameter, mark "X" if function is only used in the standard direction, "R" if only used in the reverse direction, and "B" if used in both directions)

D Act/Deact of persistent cyclic or periodic transmission of the addressed object

Test procedure

(Station-specific parameter, mark "X" if function is only used in the standard direction, "R" if only used in the reverse direction, and "B" if used in both directions)

D Test procedure

File transfer

(Station-specific parameter, mark "X" if function is used) File transfer in monitor direction.

D Transparent file

D Transmission of disturbance data of protection equipment

D Transmission of sequence of events

D Transmission of sequence of recorded analogue values

File transfer in control direction

D Transparent file

Background scan

(Station-specific parameter, mark "X" if function is only used in the standard direction, "R" if only used in the reverse direction, and "B" if used in both directions)

D Background scan

Definition of time outs

Parameter	Default Value	Remarks	Selected Value
t0	60 seconds	Time-out of connection establishment	60 seconds
t1	15 seconds	Time-out of send or test APDUs	
t2	10 seconds	Time-out for acknowledges in case of no data messages (t2< t1)	
t3	20 seconds	Time-out for sending test frames in case of a long idle time	

Maximum range of values for configurable time-outs: 1 to 255 seconds, accuracy 1 second. (*t1*, *t2*, and *t3* only)

Maximum number of outstanding I format APDUs *k* and latest acknowledge APDUs (*w*)

Parameter	Default Value	Remarks
k	12 APDUs	Maximum difference receive sequence number to send state variable (Maximum value is 19)
w	8 APDUs	Latest acknowledge after receiving <i>w</i> I format APDUs

Maximum range of values *k*: 1 to 32767 (215-1) APDUs, accuracy 1 APDU
 Maximum range of values *w*: 1 to 32767 (215-1) APDUs, accuracy 1 APDU
 (Recommendation: *w* should not exceed two-thirds of *k*).

Port number

Parameter	Value	Remarks
Port number	2404	In all cases

RFC 2200 suite

RFC 2200 is an official Internet Standard which describes the state of standardization of protocols used in the Internet as determined by the Internet Architecture Board (IAB). It offers a broad spectrum of actual standards used in the Internet. The suitable selection of documents from RFC 2200 defined in this standard for given projects has to be chosen by the user of this standard.

<input checked="" type="checkbox"/>	Ethernet 802.3
<input type="checkbox"/>	Serial X.21 interface
<input type="checkbox"/>	Other selection from RFC 2200:

6 Support, Service & Warranty

6.1 Contacting Technical Support

ProSoft Technology, Inc. is committed to providing the most efficient and effective support possible. Before calling, please gather the following information to assist in expediting this process:

- 1 Product Version Number
- 2 System architecture
- 3 Network details

If the issue is hardware related, we will also need information regarding:

- 1 Module configuration and associated ladder files, if any
- 2 Module operation and any unusual behavior
- 3 Configuration/Debug status information
- 4 LED patterns
- 5 Details about the interfaced serial, Ethernet or Fieldbus devices

Note: For technical support calls within the United States, ProSoft Technology's 24/7 after-hours phone support is available for urgent plant-down issues.

North America (Corporate Location) Phone: +1.661.716.5100 info@prosoft-technology.com Languages spoken: English, Spanish REGIONAL TECH SUPPORT support@prosoft-technology.com	Europe / Middle East / Africa Regional Office Phone: +33.(0)5.34.36.87.20 france@prosoft-technology.com Languages spoken: French, English REGIONAL TECH SUPPORT support.emea@prosoft-technology.com
Latin America Regional Office Phone: +52.222.264.1814 latinam@prosoft-technology.com Languages spoken: Spanish, English REGIONAL TECH SUPPORT support.la@prosoft-technology.com	Asia Pacific Regional Office Phone: +60.3.2247.1898 asiapc@prosoft-technology.com Languages spoken: Bahasa, Chinese, English, Japanese, Korean REGIONAL TECH SUPPORT support.ap@prosoft-technology.com

For additional ProSoft Technology contacts in your area, please visit:

www.prosoft-technology.com/About-Us/Contact-Us.

6.2 Warranty Information

For complete details regarding ProSoft Technology's TERMS & CONDITIONS OF SALE, WARRANTY, SUPPORT, SERVICE AND RETURN MATERIAL AUTHORIZATION INSTRUCTIONS, please see the documents at:

www.prosoft-technology.com/legal