



## Operating Manual QuickServer FS-QS-3XX0-F Start-up Guide



Revision: 1.N

Document No.: T18627

Print Spec: 10000005389 (F)



## fieldserver

MSA Safety  
1000 Cranberry Woods Drive  
Cranberry Township, PA 16066 USA

U.S. Support Information:  
+1 408 964-4443  
+1 800 727-4377  
Email: [smc-support@msasafety.com](mailto:smc-support@msasafety.com)

EMEA Support Information:  
+31 33 808 0590  
Email: [smc-support.emea@msasafety.com](mailto:smc-support.emea@msasafety.com)

For your local MSA contacts, please go to our website [www.MSAsafety.com](http://www.MSAsafety.com)

# Contents

<b>1</b>	<b>About the QuickServer</b>	<b>5</b>
1.1	Certification	5
1.2	Supplied Equipment	5
<b>2</b>	<b>Equipment Setup</b>	<b>6</b>
2.1	Mounting	6
2.2	Physical Dimensions	7
<b>3</b>	<b>Installation</b>	<b>8</b>
3.1	DIP Switch Settings	8
3.1.1	Bias Resistors	8
3.1.2	Termination Resistor	9
3.2	Connecting the R1 & R2 Ports	10
3.2.1	Wiring	10
3.2.2	Supported RS-485 Baud Rates by Protocol	10
3.3	10/100 Ethernet Connection Port	11
<b>4</b>	<b>Power up the Gateway</b>	<b>12</b>
<b>5</b>	<b>Connect the PC to the Gateway</b>	<b>13</b>
5.1	Connecting to the Gateway via Ethernet	13
5.1.1	Changing the Subnet of the Connected PC	13
<b>6</b>	<b>Setup Web Server Security</b>	<b>14</b>
6.1	Login to the FieldServer	14
6.2	Select the Security Mode	16
6.2.1	HTTPS with Own Trusted TLS Certificate	17
6.2.2	HTTPS with Default Untrusted Self-Signed TLS Certificate or HTTP with Built-in Payload Encryption	17
<b>7</b>	<b>Setup Network</b>	<b>18</b>
7.1	Using FS-GUI to Input Network Settings	19
7.2	Routing Settings	20
7.3	Ethernet 1 and Ethernet 2 Network Settings – LAN Mode	21
7.4	Ethernet 2 Network Settings – WAN Mode	22
<b>8</b>	<b>Configuring the QuickServer</b>	<b>23</b>
8.1	Retrieve the Sample Configuration File	23
8.2	Change the Configuration File to Meet the Application	23
8.3	Load the Updated Configuration File	24
8.3.1	Using the FS-GUI to Load a Configuration File	24
8.3.2	Retrieve the Configuration File for Modification or Backup	25
8.4	Test and Commission the QuickServer	26
8.4.1	Accessing the FieldServer Manager	26
<b>9</b>	<b>Troubleshooting</b>	<b>27</b>
9.1	Lost or Incorrect IP Address	27
9.2	Viewing Diagnostic Information	28
9.3	Checking Wiring and Settings	29
9.4	Taking a FieldServer Diagnostic Capture	30

9.5	LED Functions .....	31
9.6	Factory Reset Instructions .....	32
9.7	Internet Browser Software Support .....	32
<b>10</b>	<b>Additional Information .....</b>	<b>33</b>
10.1	Change Web Server Security Settings After Initial Setup .....	33
10.1.1	Change Security Mode .....	34
10.1.2	Edit the Certificate Loaded onto the FieldServer .....	35
10.2	Change User Management Settings .....	36
10.2.1	Create Users .....	37
10.2.2	Edit Users .....	38
10.2.3	Delete Users .....	39
10.2.4	Change FieldServer Password .....	40
10.3	Specifications .....	41
10.4	Warnings .....	41
10.5	Compliance with EN IEC 62368-1 .....	42
<b>11</b>	<b>Limited 2 Year Warranty .....</b>	<b>43</b>

# 1 About the QuickServer

The QuickServer is a high performance, cost effective Building and Industrial Automation multi-protocol gateway providing protocol translation between serial/Ethernet devices and networks.

**NOTE:** For troubleshooting assistance refer to **Section 9 Troubleshooting**, or any of the troubleshooting appendices in the related driver supplements. Check the **MSA Safety website** for technical support resources and documentation that may be of assistance.

The QuickServer is cloud ready and connects with MSA Safety's Grid. See **Section 8.4.1 Accessing the FieldServer Manager** for further information.

## 1.1 Certification

### BTL Mark – BACnet Testing Laboratory



The BTL Mark on the FieldServer is a symbol that indicates that a product has passed a series of rigorous tests conducted by an independent laboratory which verifies that the product correctly implements the BACnet features claimed in the listing. The mark is a symbol of a high-quality BACnet product.

Go to [www.BACnetInternational.net](http://www.BACnetInternational.net) for more information about the BACnet Testing Laboratory. Click [here](#) for the BACnet PIC Statement. *BACnet is a registered trademark of ASHRAE.*

## 1.2 Supplied Equipment

### FieldServer Gateway

- Preloaded with two selected drivers. A sample configuration file is also loaded.
- All instruction manuals, driver manuals, support utilities are available on the USB drive provided in the optional accessory kit, or on the MSA website.

**Accessory kit (optional)** (Part # FS-8915-38-QS) includes:

- 7-ft Cat-5 cable with RJ45 connectors at both ends
- Power Supply -110/220V (p/n 69196)
- Screwdriver for connecting to terminals
- USB Flash drive loaded with:
  - Start-up Guide
  - FieldServer Configuration Manual
  - All FieldServer Driver Manuals
  - Support Utilities
  - Any additional folders related to special files configured for a specific FieldServer
  - Additional components as required - see driver manual supplement for details

## 2 Equipment Setup

### 2.1 Mounting

The gateway can be mounted using the DIN rail mounting bracket on the back of the unit.



## 2.2 Physical Dimensions

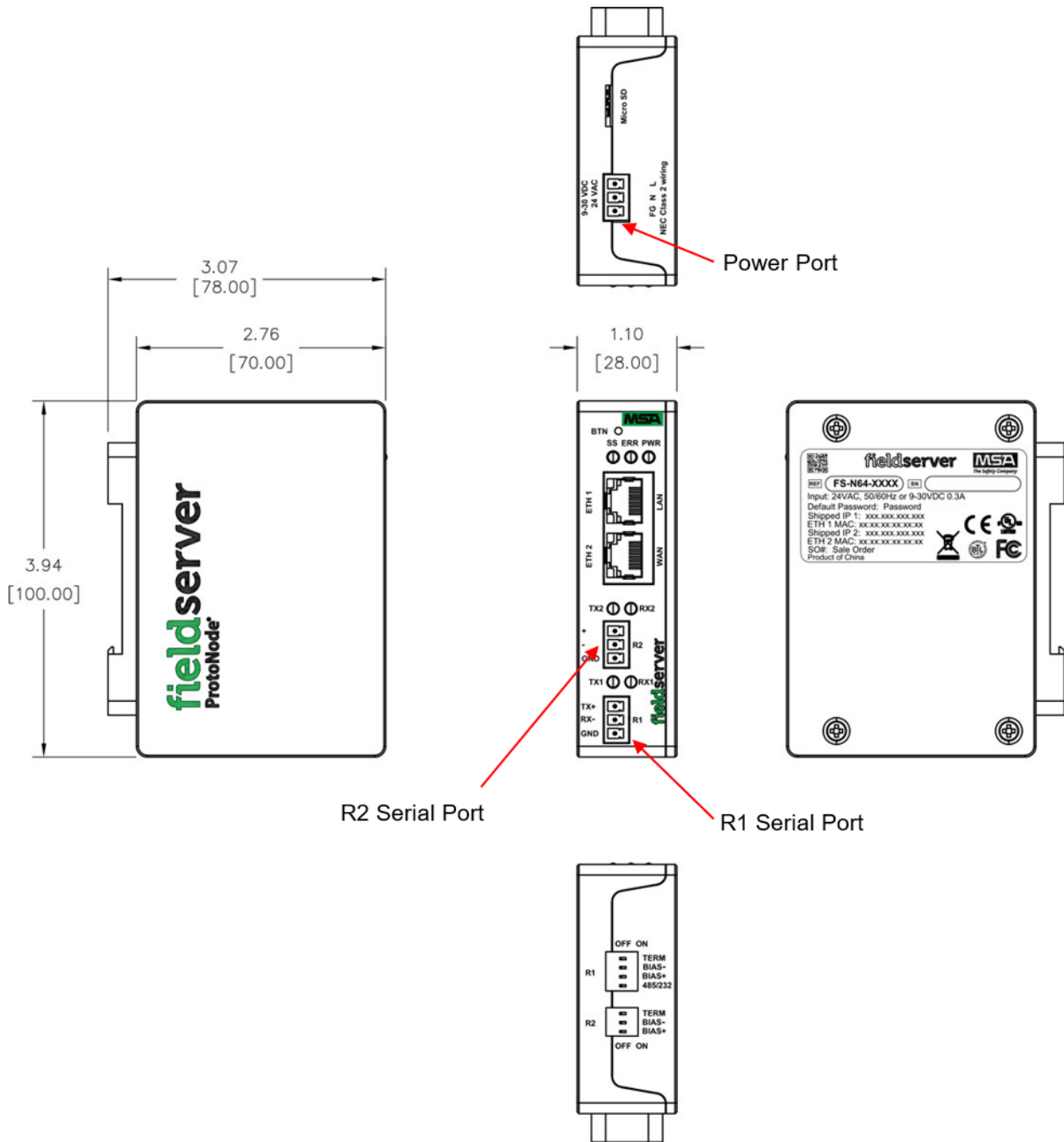

### 3 Installation

#### 3.1 DIP Switch Settings

##### 3.1.1 Bias Resistors

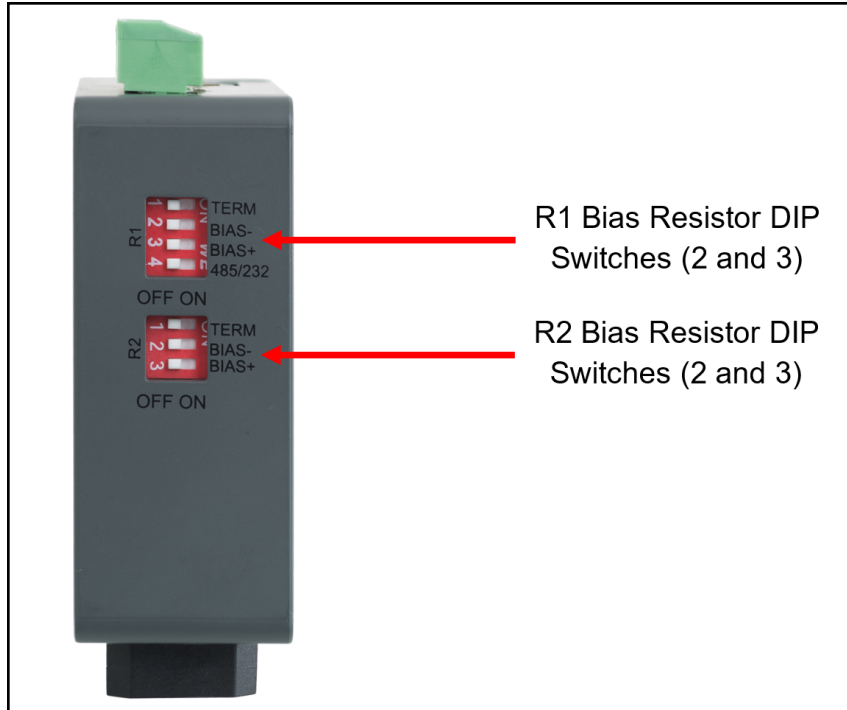

To enable Bias Resistors, move both the BIAS- and BIAS+ dip switches to the right in the orientation shown above.

The bias resistors are used to keep the RS-485 bus to a known state, when there is no transmission on the line (bus is idling), to help prevent false bits of data from being detected. The bias resistors typically pull one line high and the other low - far away from the decision point of the logic.

The bias resistor is 510 ohms which is in line with the BACnet spec. It should only be enabled at one point on the bus (for example, on the field port where there are very weak bias resistors of 100k). Since there are no jumpers, many QuickServers can be put on the network without running into the bias resistor limit which is < 500 ohms.

**NOTE:** See the [Termination and Bias Resistance Enote](#) for additional information.

**NOTE:** The R1 and R2 DIP Switches apply settings to the respective serial port.

**NOTE:** If the gateway is already powered on, DIP switch settings will not take effect unless the unit is power cycled.



### 3.1.2 Termination Resistor

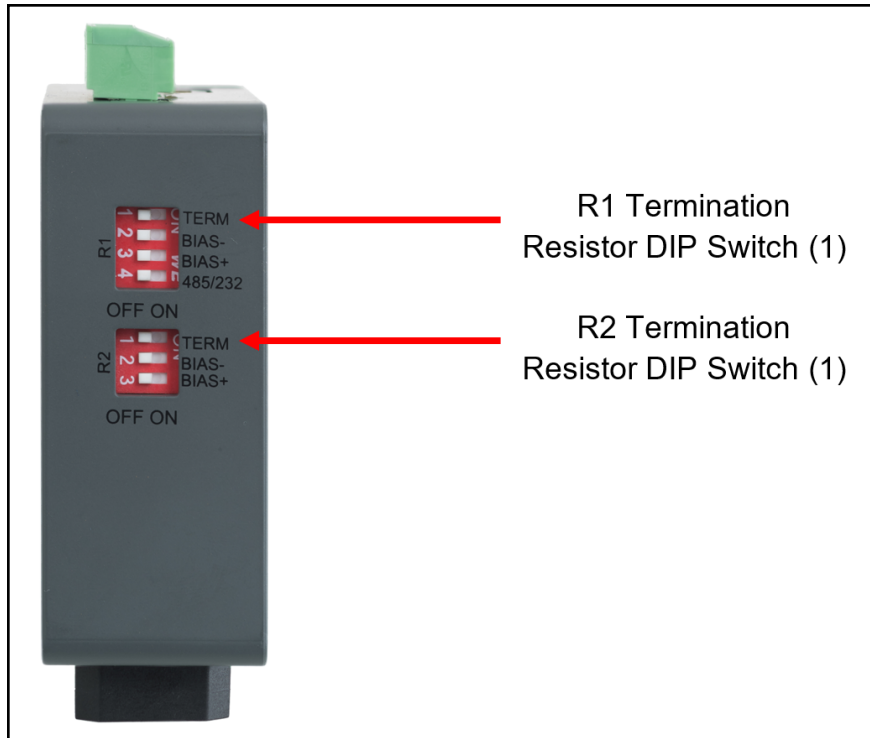

If the gateway is the last device on the serial trunk, then the End-Of-Line Termination Switch needs to be enabled. **To enable the Termination Resistor, move the TERM dip switch to the right in the orientation shown in above.**

Termination resistor is also used to reduce noise. It pulls the two lines of an idle bus together. However, the resistor would override the effect of any bias resistors if connected.

**NOTE: The R1 and R2 DIP Switches apply settings to the respective serial port.**

**NOTE: If the gateway is already powered on, DIP switch settings will not take effect unless the unit is power cycled.**

### 3.2 Connecting the R1 & R2 Ports

**For the R1 Port only:** Switch between RS-485 and RS-232 by moving the number 4 DIP Switch left for RS-485 and right for RS-232 (see images in **Section 3.1 DIP Switch Settings**).

The R2 Port is RS-485.

Connect to the 3-pin connector(s) as shown below.

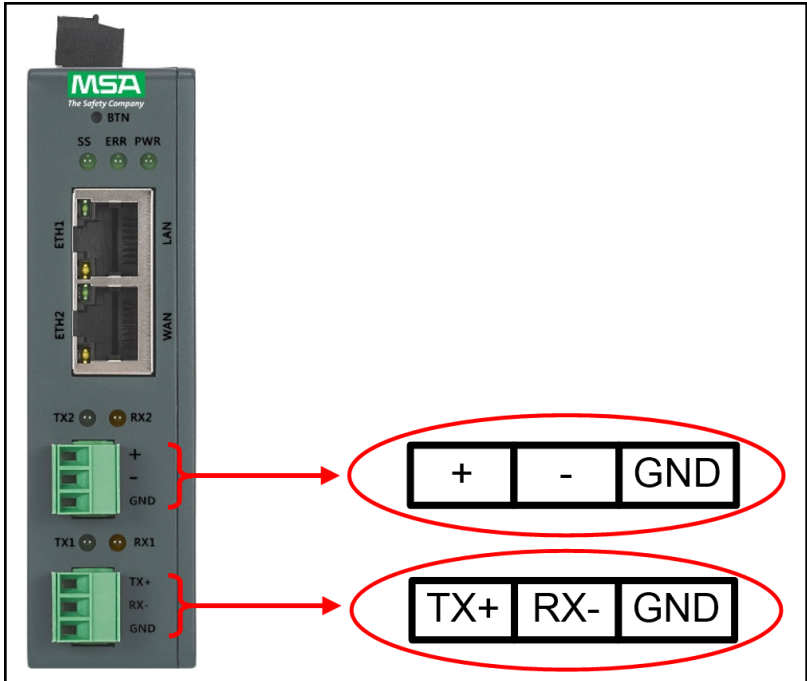

#### 3.2.1 Wiring

RS-485		RS-232	
BMS RS-485 Wiring	Gateway Pin Assignment	BMS RS-485 Wiring	Gateway Pin Assignment
RS-485 +	TX +	RS-232 -	TX +
RS-485 -	RX -	RS-232 +	RX -
GND	GND	GND	GND

**NOTE:** The RS-485/RS-232 is part of the RS-485/RS-232 interface and must be connected to the corresponding terminal on the BMS. If the cable is shielded, the shield must be connected only at one end and to earth ground – it will help suppress the electromagnetic field interference. (Connecting the shield at both ends will likely produce current loops, which could produce noise or interference that the shield was intended to block).

#### 3.2.2 Supported RS-485 Baud Rates by Protocol

The supported baud rates for either port is based on the protocol of the connected devices.

The following baud rates are supported for Modbus RTU:  
2400, 4800, 9600, 19200, 38400, 57600, 76800, 115200

The following baud rates are supported for BACnet MS/TP:  
9600, 19200, 38400, 76800, 115200

### 3.3 10/100 Ethernet Connection Port

**NOTE:** Do not use shielded Ethernet cables.

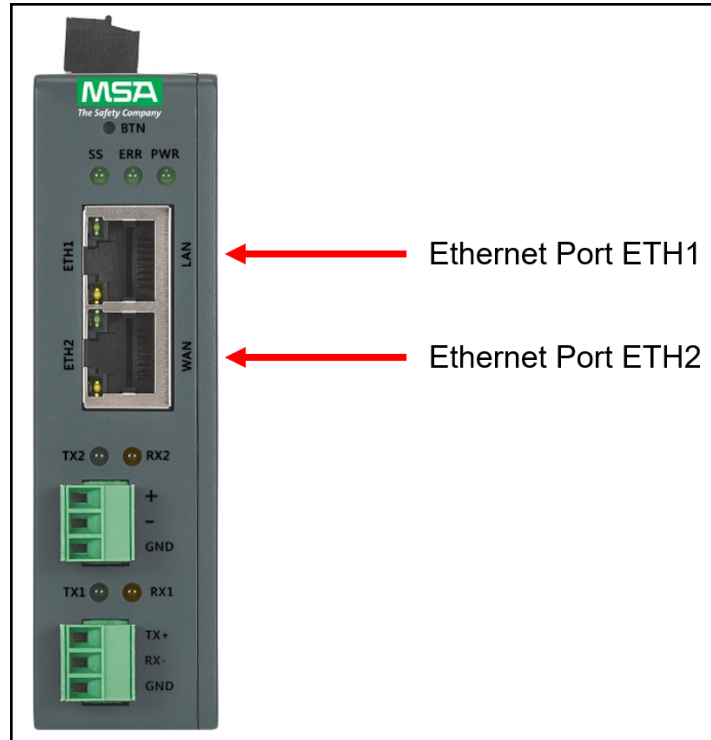

The Ethernet Port is used both for Ethernet protocol communications and for configuring the gateway via the Web App. To connect the gateway, either connect the PC to the router's Ethernet port or connect the router and PC to an Ethernet switch. Use Cat-5 cables for the connection.

**NOTE:** The Default IP Address of the gateway is 192.168.2.101, Subnet Mask is 255.255.255.0.

**NOTE:** The ETH2 port can be set to WAN mode to limit Ethernet traffic. See Section [7.4 Ethernet 2 Network Settings – WAN Mode](#) for details.

**NOTE:** ETH1 and ETH2 must be configured with IP Addresses on different IP subnets.

**NOTE:** If the Dual Ethernet FieldServer is a client on ETH1 and a server on ETH2 using the same protocol, the TCP or UDP ports need to be unique among the ETH1 and ETH2 ports.

## 4 Power up the Gateway

Check power requirements in the table below:

Power Requirement for QuickServer External Gateway		
QuickServer Family	Current Draw Type	
	12VDC	24VDC/AC
FS-QS-3X10-F (Typical)	250mA	125mA
<b>NOTE: These values are 'nominal' and a safety margin should be added to the power supply of the host system. A safety margin of 25% is recommended.</b>		

Apply power to the QuickServer as shown below. Ensure that the power supply used complies with the specifications provided in **Section 10.3 Specifications**.

- The gateway accepts 9-30VDC or 24VAC on pins L+ and N-.
  - Supports both Full-Wave and Half-Wave AC
- Frame GND should be connected to ensure personnel safety and to limit material damages due to electrical faults. Ground planes are susceptible to transient events that cause sudden surges in current. The frame ground connection provides a safe and effective path to divert the excess current from the equipment to earth ground.

**NOTE: Floating AC Power Supplies are supported.**

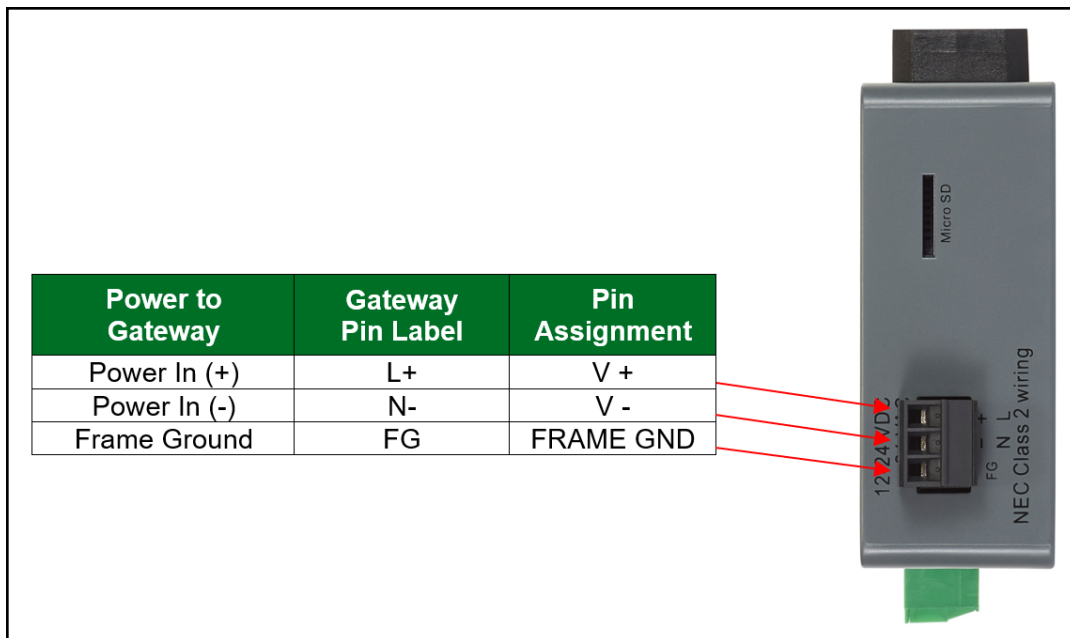

## 5 Connect the PC to the Gateway

### 5.1 Connecting to the Gateway via Ethernet

Connect a Cat-5 Ethernet cable (straight through or cross-over) between the local PC and QuickServer ETH1 (LAN Port).

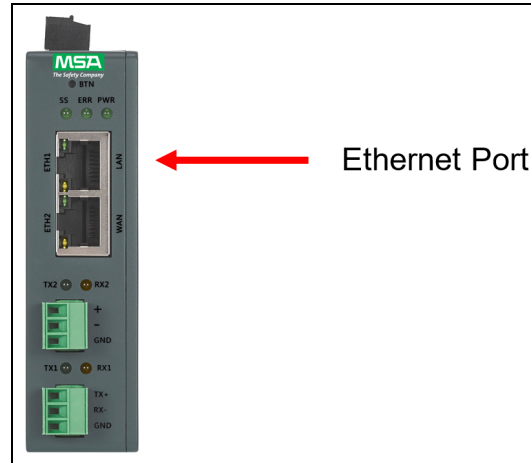

#### 5.1.1 Changing the Subnet of the Connected PC

The default IP Address for the QuickServer is **192.168.2.101**, Subnet Mask is **255.255.255.0**. If the PC and QuickServer are on different IP networks, assign a static IP Address to the PC on the 192.168.2.xxx network.

For Windows 10:

- Use the search field in the local computer's taskbar (to the right of the windows icon ) and type in "Control Panel".
- Click "Control Panel", click "Network and Internet" and then click "Network and Sharing Center".
- Click "Change adapter settings" on the left side of the window.
- Right-click on "Local Area Connection" and select "Properties" from the dropdown menu.
- Highlight  [Internet Protocol Version 4 \(TCP/IPv4\)](#) and then click the Properties button.
- Select and enter a static IP Address on the same subnet. For example:

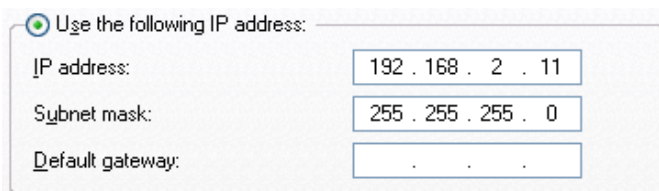

Use the following IP address:	
IP address:	192 . 168 . 2 . 11
Subnet mask:	255 . 255 . 255 . 0
Default gateway:	. . .

- Click the Okay button to close the Internet Protocol window and the Close button to exit the Ethernet Properties window.

## 6 Setup Web Server Security

### 6.1 Login to the FieldServer

The first time the FieldServer GUI is opened in a browser, the IP Address for the gateway will appear as untrusted. This will cause the following pop-up windows to appear.

- When the Web Server Security Unconfigured window appears, read the text and choose whether to move forward with HTTPS or HTTP.

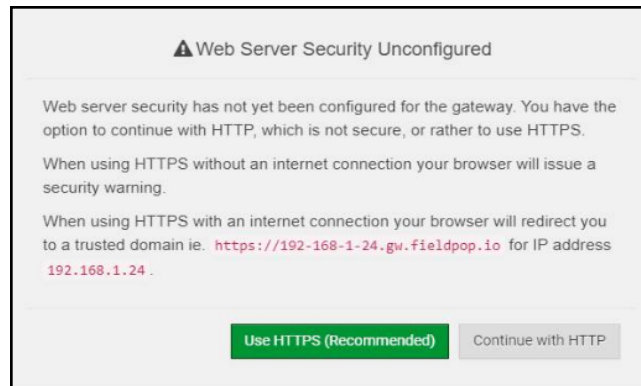

- When the warning that "Your connection is not private" appears, click the advanced button on the bottom left corner of the screen.

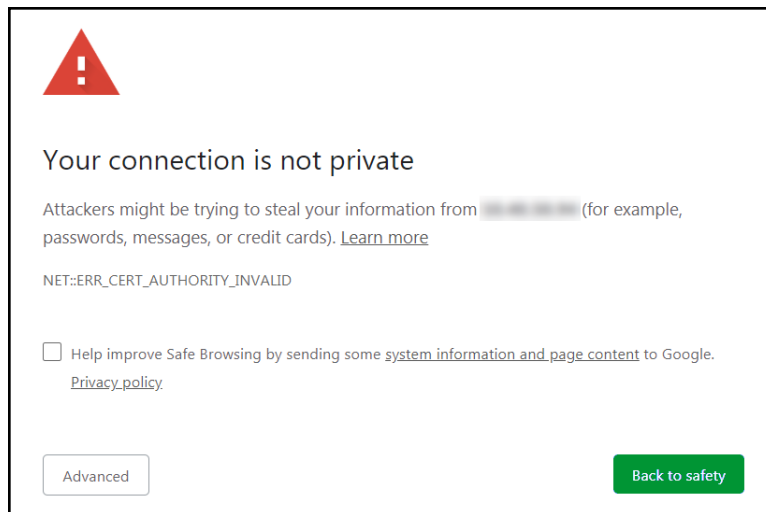

- Additional text will expand below the warning, click the underlined text to go to the IP Address. In the example below this text is “[Proceed to <FieldServer IP> \(unsafe\)](#)”.

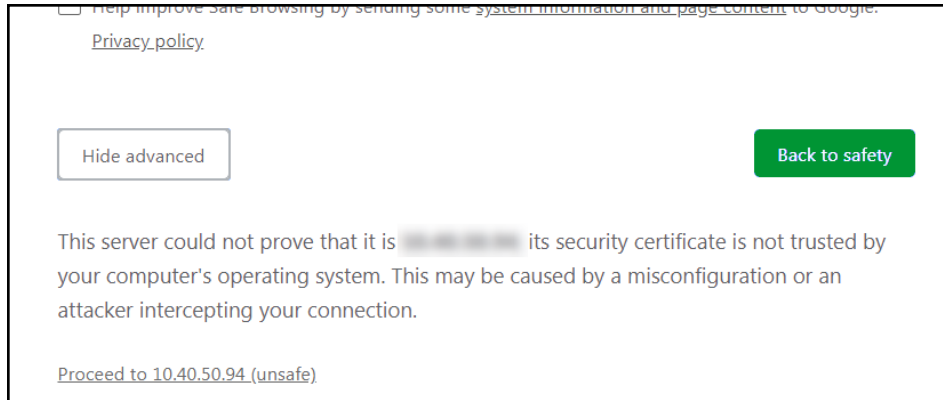

- When the login screen appears, put in the Username (default is “admin”) and the Password (found on the label of the FieldServer).

**NOTE:** There is also a QR code in the top right corner of the FieldServer label that shows the default unique password when scanned.

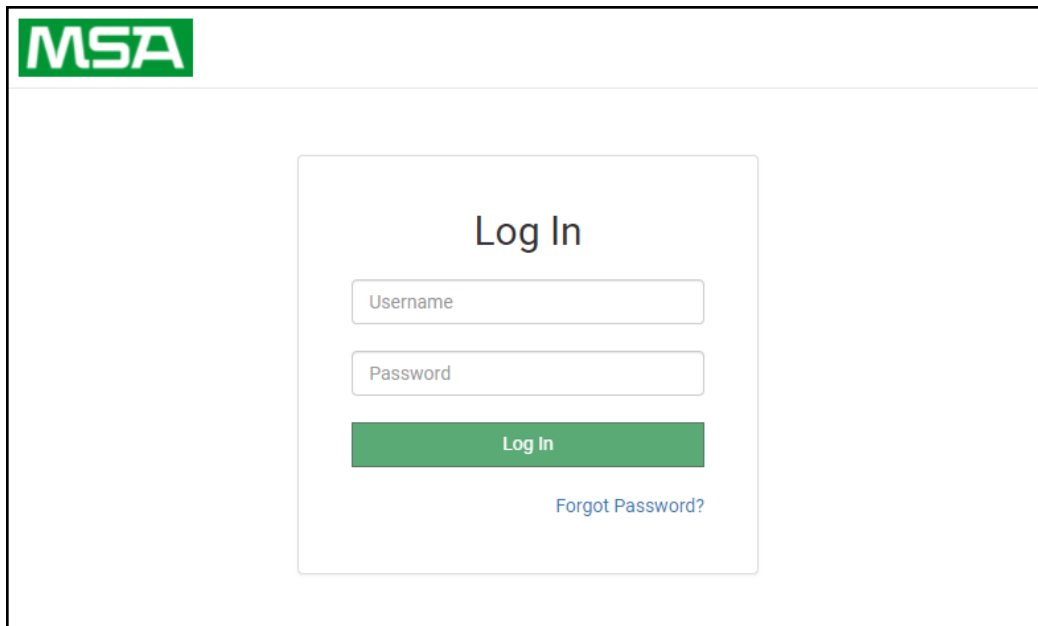

**NOTE:** A user has 5 attempts to login then there will be a 10-minute lockout. There is no timeout on the FieldServer to enter a password.

**NOTE:** To create individual user logins, go to Section [10.2 Change User Management Settings](#).

## 6.2 Select the Security Mode

On the first login to the FieldServer, the following screen will appear that allows the user to select which mode the FieldServer should use.

**Web server security is not configured**



Please select the web security profile from the options below.

Note that browsers will issue a security warning when browsing to a HTTPS server with an untrusted self-signed certificate.

**Mode**

- HTTPS with default trusted TLS certificate (requires internet connection to be trusted)
- HTTPS with own trusted TLS certificate
- HTTP (not secure, vulnerable to man-in-the-middle attacks)

**Save**

**NOTE:** Cookies are used for authentication.

**NOTE:** To change the web server security mode after initial setup, go to [Section 10.1 Change Web Server Security Settings After Initial Setup](#).

The sections that follow include instructions for assigning the different security modes.



## 6.2.1 HTTPS with Own Trusted TLS Certificate

This is the recommended selection and the most secure. **Please contact your IT department to find out if you can obtain a TLS certificate from your company before proceeding with the Own Trusted TLS Certificate option.**

- Once this option is selected, the Certificate, Private Key and Private Key Passphrase fields will appear under the mode selection.

### Certificate

```
XzyMbQZFIRuJZJPe7CTHLcHORHlowoUFoVTaBMYd4d6VGdNklKazByWKcNOL7mrX
A4IBAQBfM+IPvOx3T/47VEmaiXqE3bx3zEuBFJ6pWPlw7LHf2r2ZoHw+9xb+aNMU
dVyAelhBMTMsnI2ERvQVp0xj3psSv2EJyKXS1bOYNRLsq7UzpwuAdT/Wy3o6vUM5
K+Cwf9qEoQ0LuxDZTIECT67MkcHMiuFi5pk7TRicHnQF/sfOAYOulduHOy9exlk9
FmHFVDIZf/cJUaF+e74EuSph+gEr0IQo2wmmhyc7L22UXse1NoOfUJ2Zq0Eu1Vvtu
JRryaMWIRFEWuuzMGZtKEWVC+8q2JQsVcqiRWM7naoblEhOCMH+sKHJMCxDoXGt
vtZjpZUoAL51YXxWSVcyZdGiAP5e
-----END CERTIFICATE-----
```

### Private Key

```
sHB0zZoHr4YQSDk2BbYVzZbI0LDuKtc8+JiO3ooGjoTuHnqkeAj/fKfbTAsKeAzw
gKQe+H5UQNk0bdvZfOJrm6daDK2vDmR5k+juUUhEj5N49uplroB97MQgYotzqfT+
THlbpq5t1SIK617k04ObKmHF5l8fck+ru545sVmpeezh0m5j5SURYAZMvbq5daCu
J4l5NlIhbEvxRF4UK41ZDMCvujopCkBUWrb1a/3XXnDnM2K9xyz2wze998D6Wk46
+7aOFY9F+7j5lJmnkoS3GYtwCyH5jP+mPP1K6RnuiD019wwwGPb4dtN/RTnfd0eF
GYeVSkI9fxxkxDOFtdWRZbM/rPin4tmO1Xf8HqONVN1x/iaMynOXG4cukoI4+VO
u0rZaUESll2zNkfrn7fAASm5NBWg202Cy9IAYnuujs3aALl5uGBEEK62oTMxlzx
-----END RSA PRIVATE KEY-----
```

### Private Key Passphrase

- Copy and paste the Certificate and Private Key text into their respective fields. If the Private Key is encrypted type in the associated Passphrase.
- Click Save.
- A “Redirecting” message will appear. After a short time, the FieldServer GUI will open.

## 6.2.2 HTTPS with Default Untrusted Self-Signed TLS Certificate or HTTP with Built-in Payload Encryption

- Select one of these options and click the Save button.
- A “Redirecting” message will appear. After a short time, the FieldServer GUI will open.

## 7 Setup Network

Once the web server setup is complete, the FS-GUI landing page will appear.

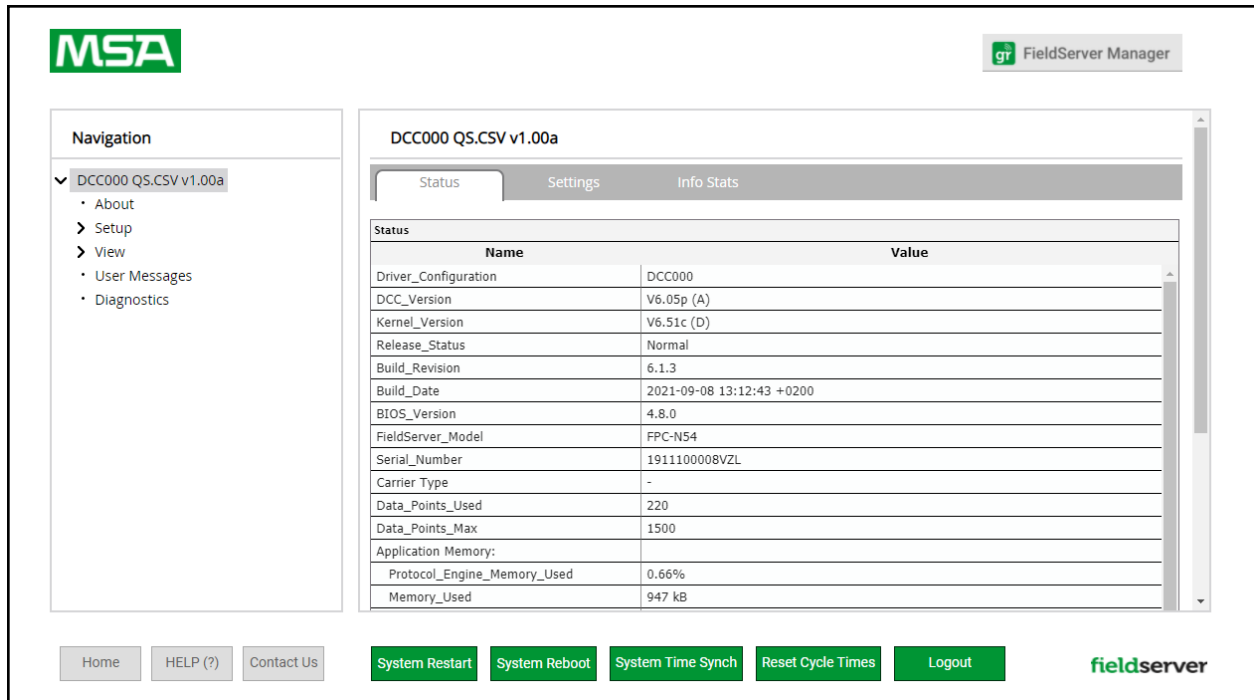

The screenshot displays the MSA FieldServer Manager interface. On the left is a navigation menu with options like 'About', 'Setup', 'View', 'User Messages', and 'Diagnostics'. The main area shows the 'Status' tab for 'DCC000 QS.CSV v1.00a'. Below the tabs is a table with system parameters and their values.

Name	Value
Driver_Configuration	DCC000
DCC_Version	V6.05p (A)
Kernel_Version	V6.51c (D)
Release_Status	Normal
Build_Revision	6.1.3
Build_Date	2021-09-08 13:12:43 +0200
BIOS_Version	4.8.0
FieldServer_Model	FPC-N54
Serial_Number	1911100008VZL
Carrier Type	-
Data_Points_Used	220
Data_Points_Max	1500
Application Memory:	
Protocol_Engine_Memory_Used	0.66%
Memory_Used	947 kB

At the bottom of the interface, there are buttons for 'Home', 'HELP (?)', 'Contact Us', 'System Restart', 'System Reboot', 'System Time Synch', 'Reset Cycle Times', and 'Logout'. The 'fieldserver' logo is visible in the bottom right corner.

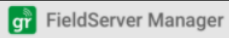
**NOTE:** The FieldServer Manager tab  (see image above) allows users to connect to the Grid, MSA Safety's device cloud solution for IIoT. The FieldServer Manager enables secure remote connection to field devices through a FieldServer and its local applications for configuration, management, maintenance. For more information about the FieldServer Manager, refer to the [MSA Grid - FieldServer Manager Start-up Guide](#).

## 7.1 Using FS-GUI to Input Network Settings

To navigate from the FS-GUI page to the Network Settings page follow the below instructions:

- Find the Navigation tree across the left side of the screen.
- Click the arrow next to the FieldServer title/CN number to expand the tree.

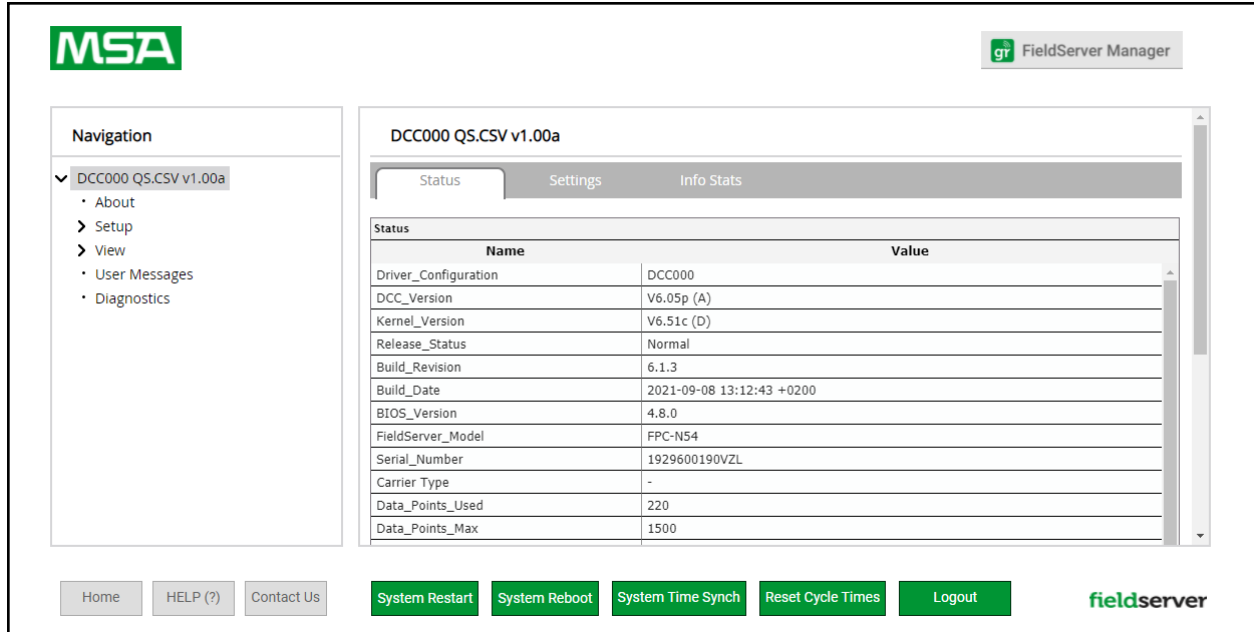

The screenshot shows the MSA FieldServer Manager interface. On the left is a navigation tree with the following items:

- Navigation
  - ▼ DCC000 QS.CSV v1.00a
    - About
    - ▶ Setup
    - ▶ View
    - User Messages
    - Diagnostics

The main content area displays the system status for DCC000 QS.CSV v1.00a. It has tabs for Status, Settings, and Info Stats. The Status tab is active, showing a table with the following data:

Name	Value
Driver_Configuration	DCC000
DCC_Version	V6.05p (A)
Kernel_Version	V6.51c (D)
Release_Status	Normal
Build_Revision	6.1.3
Build_Date	2021-09-08 13:12:43 +0200
BIOS_Version	4.8.0
FieldServer_Model	FPC-N54
Serial_Number	1929600190VZL
Carrier_Type	-
Data_Points_Used	220
Data_Points_Max	1500

At the bottom of the interface are several buttons: Home, HELP (?), Contact Us, System Restart, System Reboot, System Time Synch, Reset Cycle Times, and Logout. The fieldserver logo is in the bottom right corner.

- Click on the arrow next to Setup to expand the tree.
- Click on Network Settings.

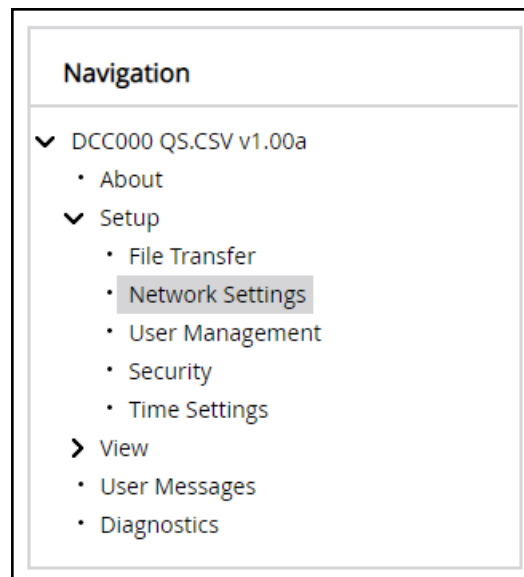

This is a close-up of the navigation tree from the previous screenshot. The 'Setup' item is expanded, and 'Network Settings' is highlighted with a grey background. The tree structure is as follows:

- Navigation
  - ▼ DCC000 QS.CSV v1.00a
    - About
    - ▼ Setup
      - File Transfer
      - Network Settings
      - User Management
      - Security
      - Time Settings
    - ▶ View
      - User Messages
      - Diagnostics

## 7.2 Routing Settings

The Routing settings make it possible to set up the IP routing rules for the FieldServer's internet and network connections.

**NOTE: The default connection is ETH1.**

- Select the default connection in the first row as either ETH 1 or ETH 2.
- Click the Add Rule button to add a new row and set a new Destination Network, Netmask and Gateway IP Address as needed.
- Set the Priority for each connection (1-255 with 1 as the highest priority and 255 as the lowest).
- Click the Save button to activate the new settings.

ETH 1   ETH 2   Routing

Set up the IP routing rules of your FieldServer for internet access and access to other networks.  
If you want to reach another device that is not connected to the local network, you can add a rule to determine on which gateway the device must be routed to.

Interface	Destination Network	Netmask	Gateway IP Address	Priority ?
ETH 1	Default	-	10.40.50.1	255
ETH 1	10.40.50.10	255.255.255.255	10.40.50.1	100
ETH 1	10.40.50.15	255.255.255.255	10.40.50.1	50

+ Add Rule

Cancel   Save

### 7.3 Ethernet 1 and Ethernet 2 Network Settings – LAN Mode

- Check that the Mode is set to LAN, if not click LAN to change the ETH 2 port to LAN mode.
- Enable DHCP to automatically assign IP Settings or modify the IP Settings manually as needed, via these fields: IP Address, Netmask, Gateway, and Domain Name Server1/2.

**NOTE:** If connected to a router, set the Gateway to the same IP Address as the router.

- Click Save to record and activate the new IP Address.
- Connect the FieldServer to the local network or router.

**NOTE:** If the webpage was open in a browser, the browser will need to be pointed to the new IP Address of the FieldServer before the webpage will be accessible again.

The screenshot displays the configuration interface for Ethernet 2 in LAN mode. The 'Mode' section has 'LAN' selected. The 'Enable DHCP' checkbox is unchecked. The IP settings are as follows:

Field	Value
IP Address	192.168.2.25
Netmask	255.255.255.0
Gateway	192.168.2.1
Domain Name Server 1 (Optional)	8.8.8.8
Domain Name Server 2 (Optional)	8.8.4.4

The 'Network Status' panel on the right provides the following information:

Metric	Value
Connection Status	Connected
MAC Address	00:50:4e:60:45:1b
Ethernet Tx Msgs	14,210,944
Ethernet Rx Msgs	77,137,100
Ethernet Tx Msgs Dropped	0
Ethernet Rx Msgs Dropped	0

## 7.4 Ethernet 2 Network Settings – WAN Mode

- Click the blue WAN box to change the ETH 2 port to WAN mode.
  - This prevents all but allowed incoming traffic on the ETH 2 port it does allow a connection to the internet via port 80 & 443

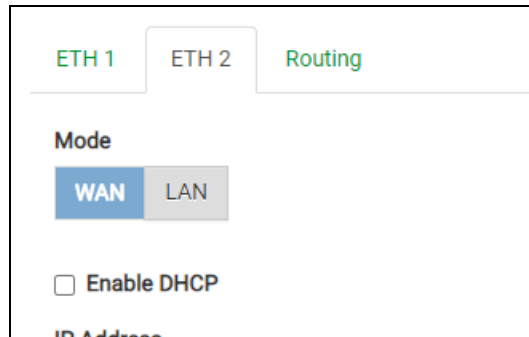

- Scroll below the network settings to get to the firewall options with rules that allow specific incoming traffic (through setting rules) and outgoing options.

**Incoming Firewall (Optional)**  
All incoming network traffic is blocked by default. You can use the incoming firewall rules to allow specified traffic to the FieldServer from the WAN network. ⓘ

**Shorthand tips** When you add rules, you can use the following symbols ▼

IP Address	Netmask (Optional)	Port Range	Description (Optional)
*		80,443,1024	Webpage and FieldServer Toc 

**+ Add Rule**

Cancel **Save**

### NOTE the following options for setting firewall rules:

- Add 1023 to the Port Range field to allow the FieldServer Toolbox access.
- Add 47808 to the Port Range field for BACnet access.
- Add 80 & 443 to the Port Range field for web browser access.
- Use a "\*" as a wild card for IP Address.

## 8 Configuring the QuickServer

### 8.1 Retrieve the Sample Configuration File

The configuration of the QuickServer is provided to the QuickServer's operating system via a comma-delimited file called "CONFIG.CSV".

If a custom configuration was ordered, the QuickServer will be programmed with the relevant device registers in the Config.csv file for the initial start-up. If not, the product is shipped with a sample config.csv that shows an example of the drivers ordered.

- In the main menu of the FS-GUI screen, go to "Setup", then "File Transfer", and finally "Retrieve".
- Click on "config.csv", and open or save the file.

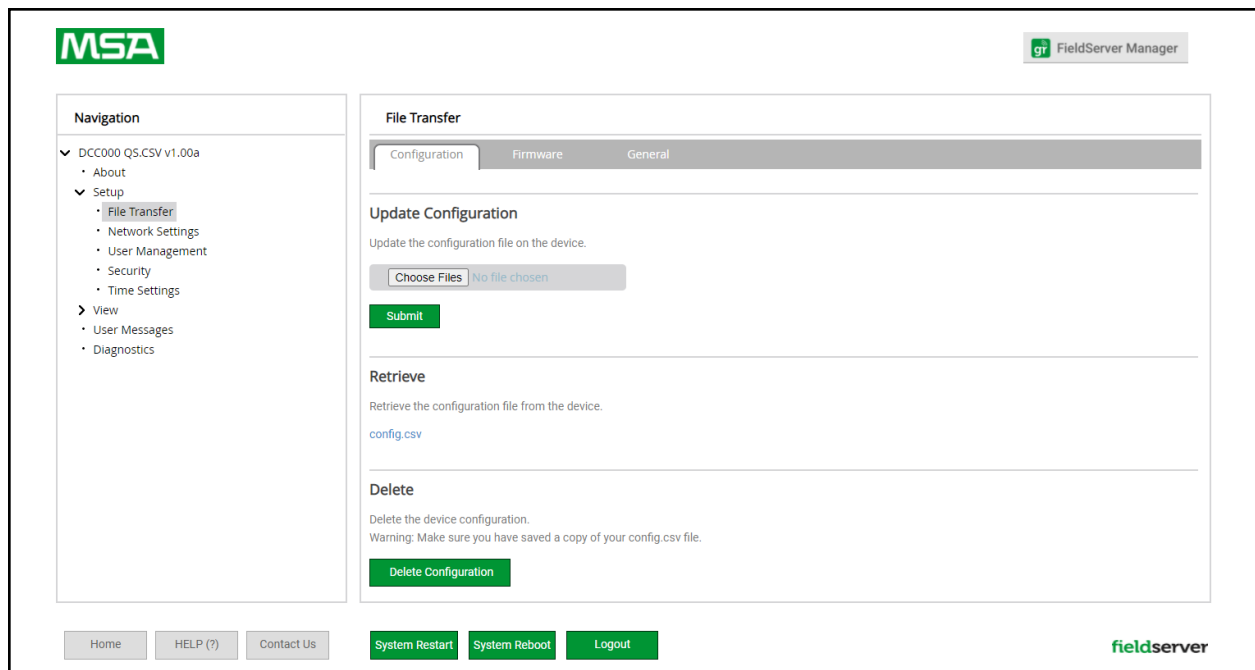

### 8.2 Change the Configuration File to Meet the Application

Refer to the FieldServer Configuration Manual in conjunction with the Driver supplements for information on configuring the QuickServer.

## 8.3 Load the Updated Configuration File

### 8.3.1 Using the FS-GUI to Load a Configuration File

- In the main menu of the FS-GUI screen, click “Setup”, then “File Transfer” and finally “Update”.
- Browse and select the .csv file, open, then click “Submit”.

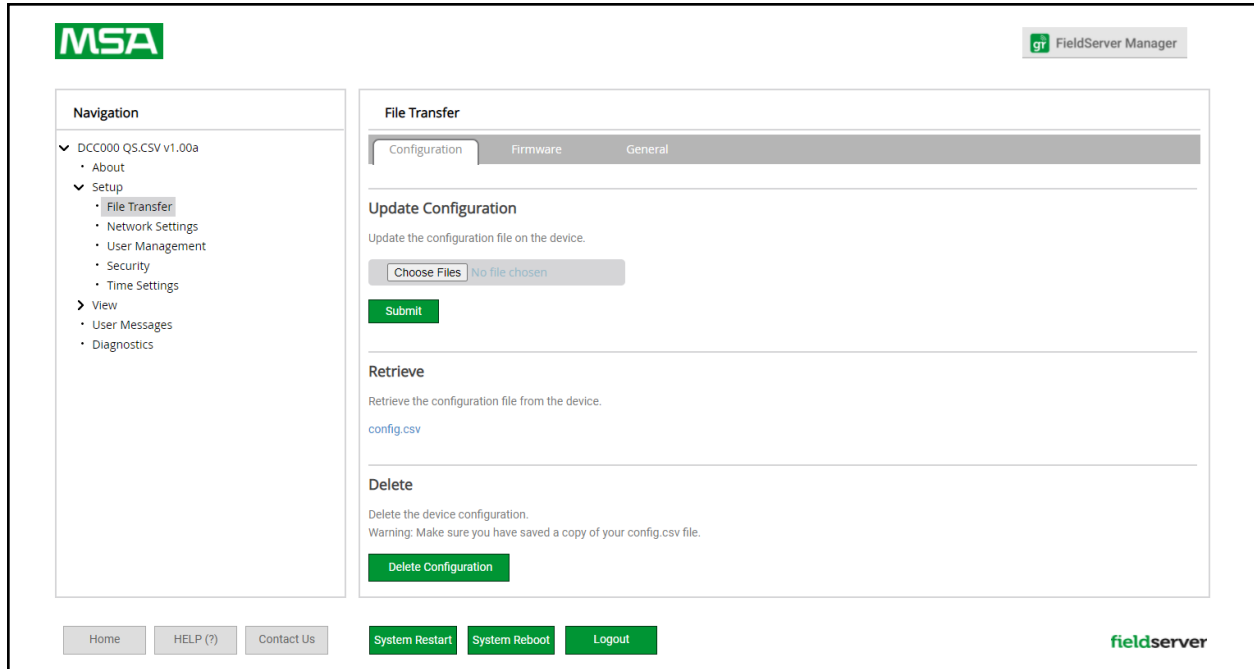

- Once download is complete, a message bar will appear confirming that the configuration was updated successfully.
- Click the System Restart Button to put the new file into operation.

**NOTE:** It is possible to do multiple downloads to the QuickServer before resetting it.



### 8.3.2 Retrieve the Configuration File for Modification or Backup

To get a copy of the configuration file for modifying or backing up a configuration on a local computer, do the following:

- In the main menu of the FS-GUI screen, click “Setup”, then “File Transfer”.

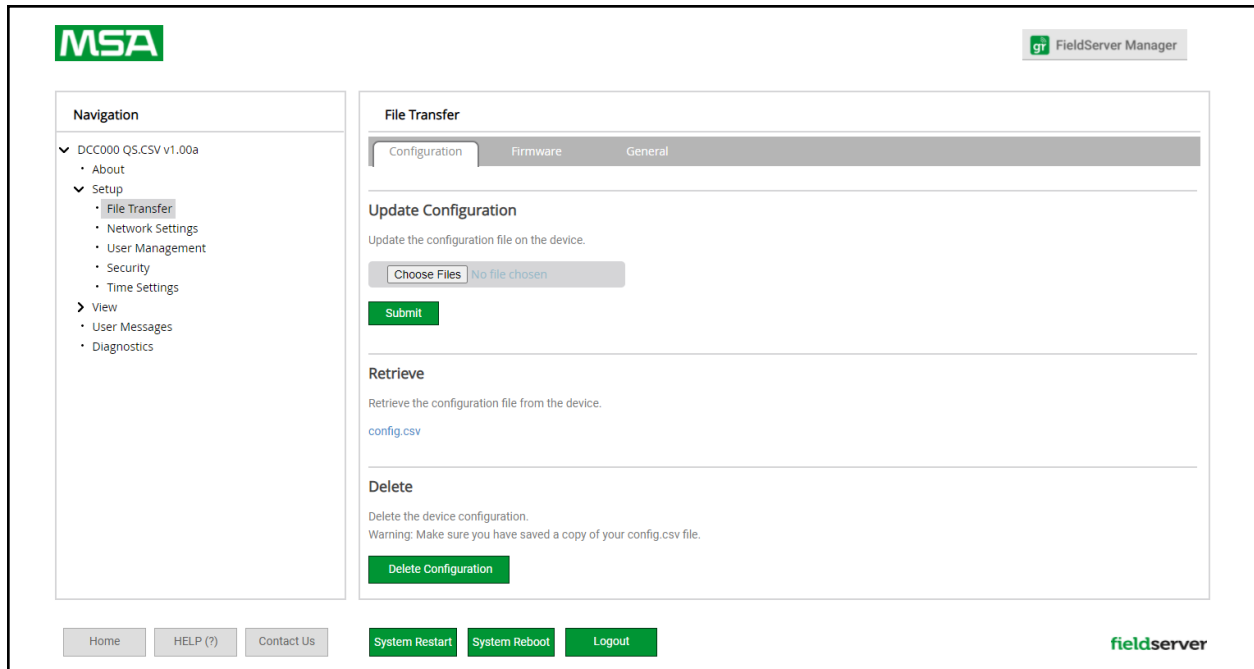

- Click the “config.csv” link under the “Retrieve” heading in the middle section of the screen.
  - The file will automatically download to the web browser’s default download location.
- Edit or store the file as desired.

**NOTE:** Before using any backup configuration file to reset the configuration settings, check that the backup file is not an old version.

## 8.4 Test and Commission the QuickServer

- Connect the QuickServer to the third party device(s), and test the application.
- From the landing page of the FS-GUI click on “View” in the navigation tree, then “Connections” to see the number of messages on each protocol.

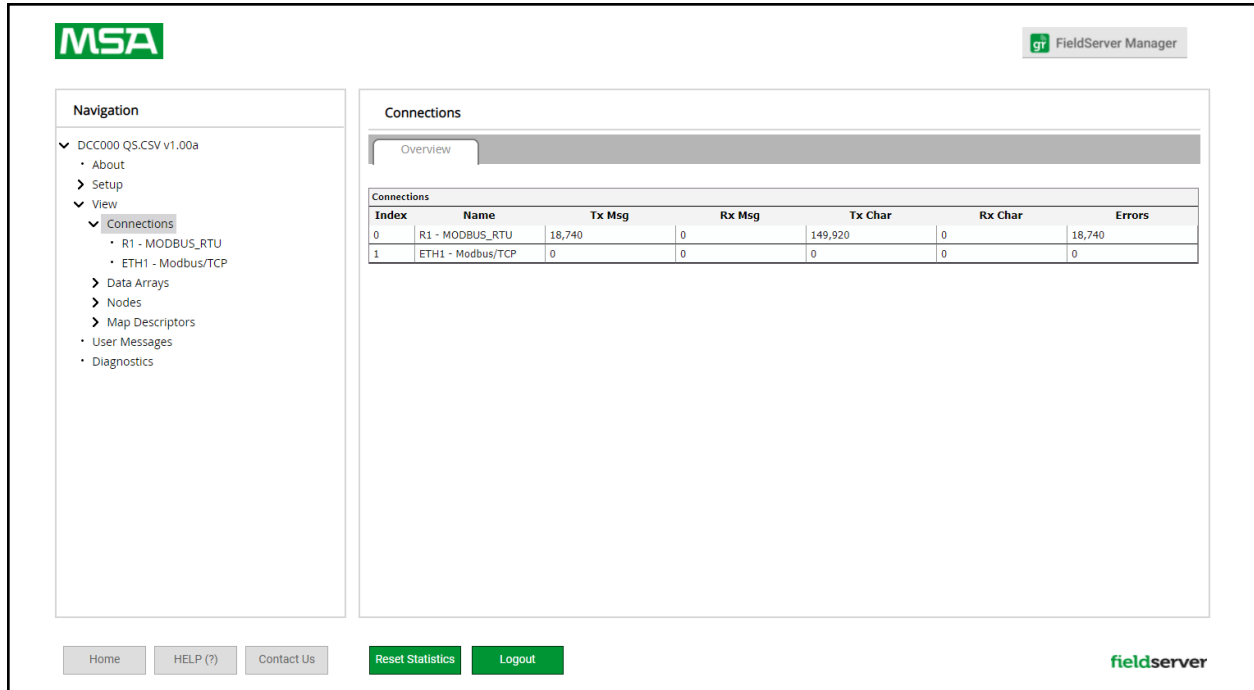

Index	Name	Tx Msg	Rx Msg	Tx Char	Rx Char	Errors
0	R1 - MODBUS_RTU	18,740	0	149,920	0	18,740
1	ETH1 - Modbus/TCP	0	0	0	0	0

**NOTE:** For troubleshooting assistance refer to [Section 9 Troubleshooting](#), or any of the troubleshooting appendices in the related driver supplements and configuration manual. MSA Safety also offers a technical support on the MSA Safety website, which contains a significant number of resources and documentation that may be of assistance.

### 8.4.1 Accessing the FieldServer Manager

**NOTE:** The FieldServer Manager tab  (see image above) allows users to connect to the Grid, MSA Safety’s device cloud solution for IIoT. The FieldServer Manager enables secure remote connection to field devices through a FieldServer and its local applications for configuration, management, maintenance. For more information about the FieldServer Manager, refer to the [MSA Grid - FieldServer Manager Start-up Guide](#).

## 9 Troubleshooting

### 9.1 Lost or Incorrect IP Address

- Ensure that FieldServer Toolbox is loaded onto the local PC. Otherwise, download the FieldServer-Toolbox.zip via the MSA Safety website.
- Extract the executable file and complete the installation.

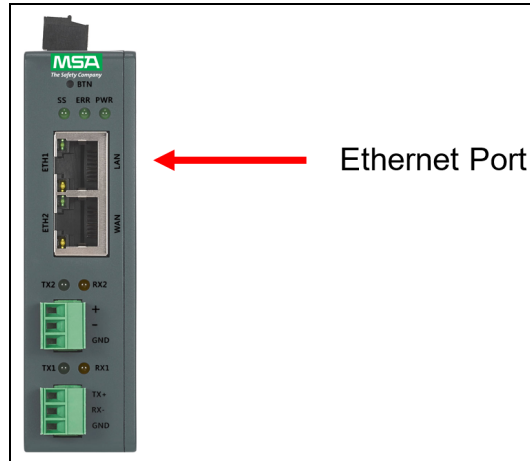

- Connect a standard Cat-5 Ethernet cable between the user's PC and QuickServer.
- Double click on the FS Toolbox Utility and click Discover Now on the splash page.
- Check for the IP Address of the desired gateway.

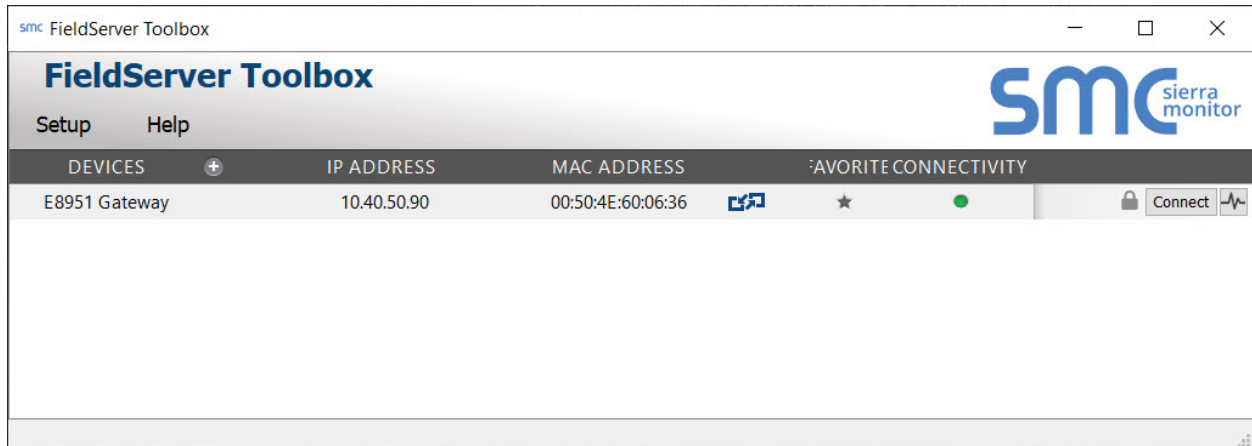

## 9.2 Viewing Diagnostic Information

- Type the IP Address of the FieldServer into the web browser or use the FieldServer Toolbox to connect to the FieldServer.
- Click on Diagnostics and Debugging Button, then click on view, and then on connections.
- If there are any errors showing on the Connection page, refer to **Section 9.3 Checking Wiring and Settings** for the relevant wiring and settings.

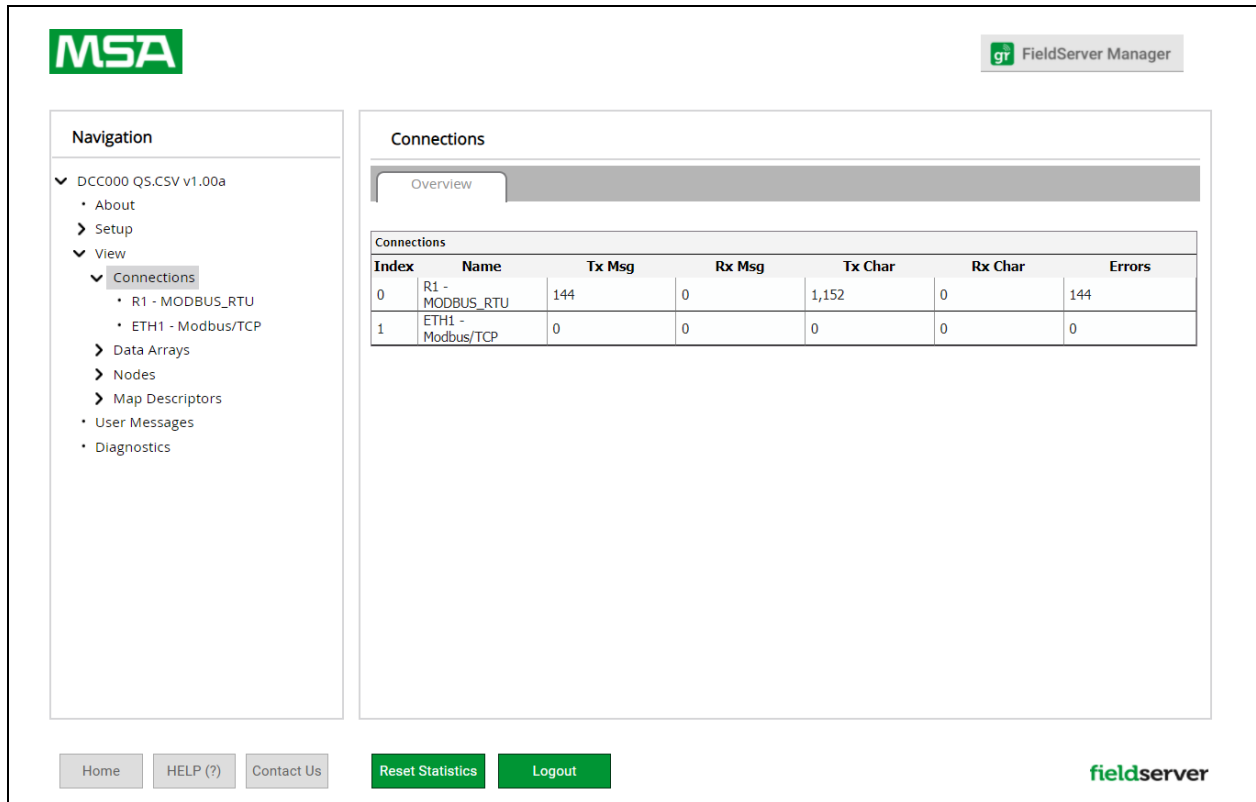

The screenshot shows the FieldServer Manager web interface. The MSA logo is in the top left, and the FieldServer Manager logo is in the top right. The navigation menu on the left includes: DCC000 QS.CSV v1.00a, About, Setup, View, Connections (highlighted), R1 - MODBUS\_RTU, ETH1 - Modbus/TCP, Data Arrays, Nodes, Map Descriptors, User Messages, and Diagnostics. The main content area is titled 'Connections' and has an 'Overview' tab selected. Below the tab is a table with the following data:

Index	Name	Tx Msg	Rx Msg	Tx Char	Rx Char	Errors
0	R1 - MODBUS_RTU	144	0	1,152	0	144
1	ETH1 - Modbus/TCP	0	0	0	0	0

At the bottom of the page, there are buttons for Home, HELP (?), Contact Us, Reset Statistics, and Logout. The fieldserver logo is in the bottom right corner.

### 9.3 Checking Wiring and Settings

No COMS on the Serial side. If the Tx/Rx LEDs are not flashing rapidly then there is a COM issue. To fix this problem, check the following:

- Visual observations of LEDs on the QuickServer. ([Section 9.5 LED Functions](#))
- Check baud rate, parity, data bits, stop bits.
- Check device address.
- Verify wiring.
- Verify the device is connected to the same subnet as the QuickServer.

Field COM problems:

- Visual observations of LEDs on the QuickServer. ([Section 9.5 LED Functions](#))
- Verify wiring.
- Verify IP Address setting.

**NOTE:** If the problem still exists, a Diagnostic Capture needs to be taken and sent to support. ([Section 9.4 Taking a FieldServer Diagnostic Capture](#))

## 9.4 Taking a FieldServer Diagnostic Capture

When there is a problem on-site that cannot easily be resolved, perform a Diagnostic Capture before contacting support. Once the Diagnostic Capture is complete, email it to technical support. The Diagnostic Capture will accelerate diagnosis of the problem.

- Access the FieldServer Diagnostics page via one of the following methods:
  - Open the FieldServer FS-GUI page and click on Diagnostics in the Navigation panel
  - Open the FieldServer Toolbox software and click the diagnose icon  of the desired device

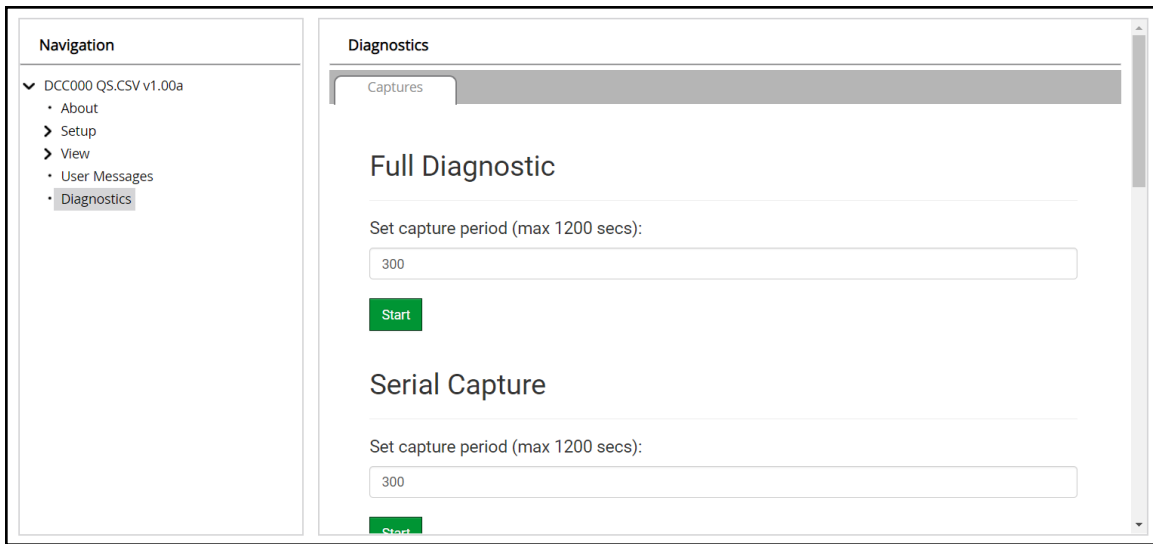

- Go to Full Diagnostic and select the capture period.
- Click the Start button under the Full Diagnostic heading to start the capture.
  - When the capture period is finished, a Download button will appear next to the Start button

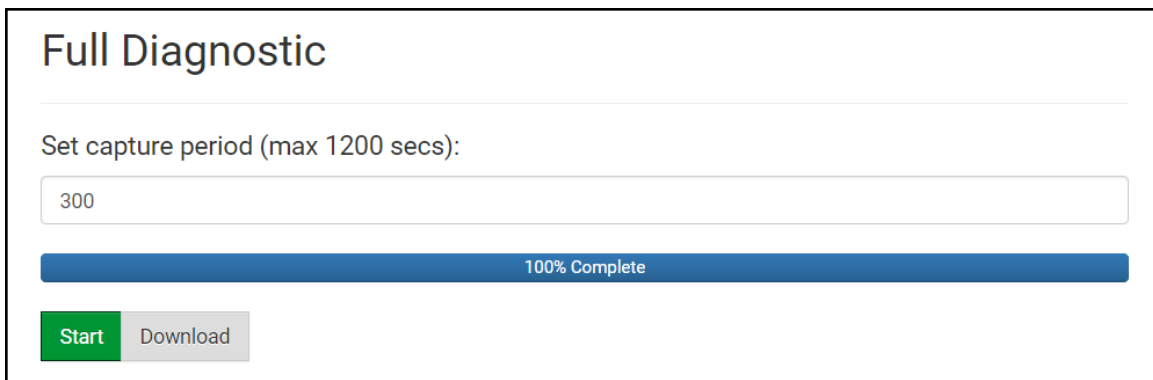

- Click Download for the capture to be downloaded to the local PC.
- Email the diagnostic zip file to technical support ([smc-support.emea@msasafety.com](mailto:smc-support.emea@msasafety.com)).

**NOTE:** Diagnostic captures of BACnet MS/TP communication are output in a “.PCAP” file extension which is compatible with Wireshark.

## 9.5 LED Functions

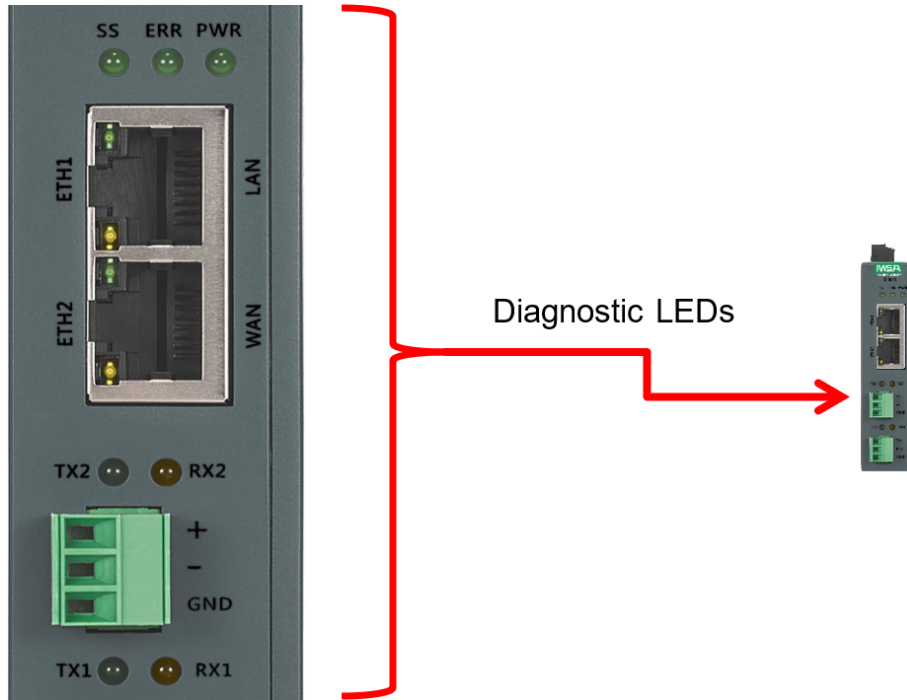

Tag	Description
<b>SS</b>	The SS LED will flash once a second to indicate that the bridge is in operation.
<b>ERR</b>	The SYS ERR LED will go on solid indicating there is a system error. If this occurs, immediately report the related "system error" shown in the error screen of the FS-GUI interface to support for evaluation.
<b>PWR</b>	This is the power light and should always be steady green when the unit is powered.
<b>RX</b>	The RX LED will flash when a message is received on the serial port on the 3-pin connector. If the serial port is not used, this LED is non-operational. RX1 applies to the R1 connection while RX2 applies to the R2 connection.
<b>TX</b>	The TX LED will flash when a message is sent on the serial port on the 3-pin connector. If the serial port is not used, this LED is non-operational. TX1 applies to the R1 connection while TX2 applies to the R2 connection.

## 9.6 Factory Reset Instructions

For instructions on how to reset a FieldServer back to its factory released state, see [ENOTE FieldServer Next Gen Recovery](#).

## 9.7 Internet Browser Software Support

The following web browsers are supported:

- Chrome Rev. 57 and higher
- Firefox Rev. 35 and higher
- Microsoft Edge Rev. 41 and higher
- Safari Rev. 3 and higher

**NOTE:** Internet Explorer is no longer supported as recommended by Microsoft.

**NOTE:** Computer and network firewalls must be opened for Port 80 to allow FieldServer GUI to function.



## 10 Additional Information

### 10.1 Change Web Server Security Settings After Initial Setup

**NOTE:** Any changes will require a FieldServer reboot to take effect.

- Navigate from the QuickServer landing page to the FS-GUI by clicking the blue “Diagnostics” text on the bottom of the screen.
- The QuickServer landing page is the FS-GUI.
- Click Setup in the Navigation panel.

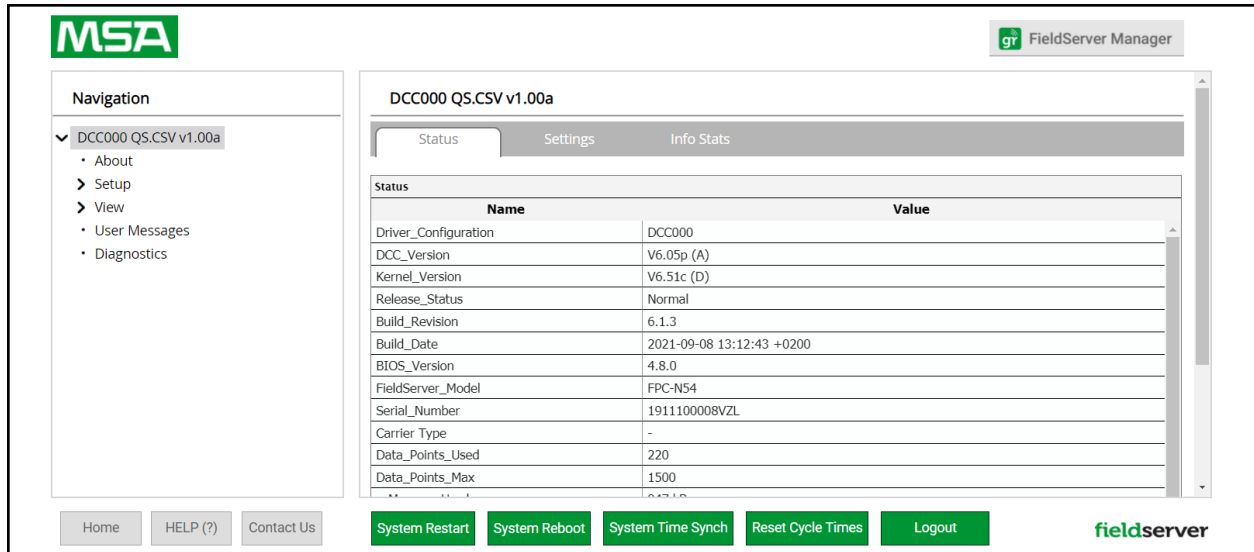

The screenshot displays the MSA FieldServer Manager web interface. The top left features the MSA logo, and the top right shows the 'FieldServer Manager' title. A navigation panel on the left lists options: 'DCC000 QS.CSV v1.00a' (selected), 'About', 'Setup', 'View', 'User Messages', and 'Diagnostics'. The main content area is titled 'DCC000 QS.CSV v1.00a' and has tabs for 'Status', 'Settings', and 'Info Stats'. The 'Status' tab is active, showing a table of system parameters:

Name	Value
Driver_Configuration	DCC000
DCC_Version	V6.05p (A)
Kernel_Version	V6.51c (D)
Release_Status	Normal
Build_Revision	6.1.3
Build_Date	2021-09-08 13:12:43 +0200
BIOS_Version	4.8.0
FieldServer_Model	FPC-N54
Serial_Number	1911100008VZL
Carrier_Type	-
Data_Points_Used	220
Data_Points_Max	1500

At the bottom of the interface, there are buttons for 'Home', 'HELP (?)', 'Contact Us', 'System Restart', 'System Reboot', 'System Time Synch', 'Reset Cycle Times', and 'Logout'. The 'fieldserver' logo is visible in the bottom right corner.

### 10.1.1 Change Security Mode

- Click Security in the Navigation panel.

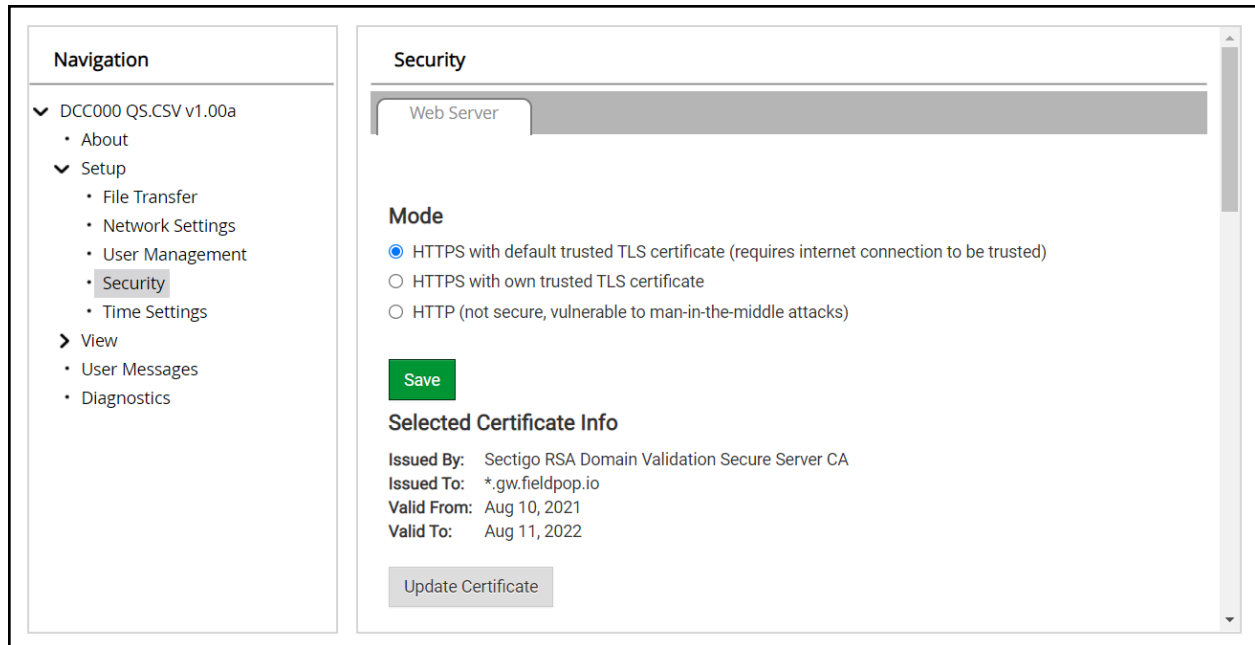

- Click the Mode desired.
  - If HTTPS with own trusted TLS certificate is selected, follow instructions in [Section 6.2.1 HTTPS with Own Trusted TLS Certificate](#)
- Click the Save button.

### 10.1.2 Edit the Certificate Loaded onto the FieldServer

**NOTE:** A loaded certificate will only be available if the security mode was previously setup as HTTPS with own trusted TLS certificate.

- Click Security in the Navigation panel.

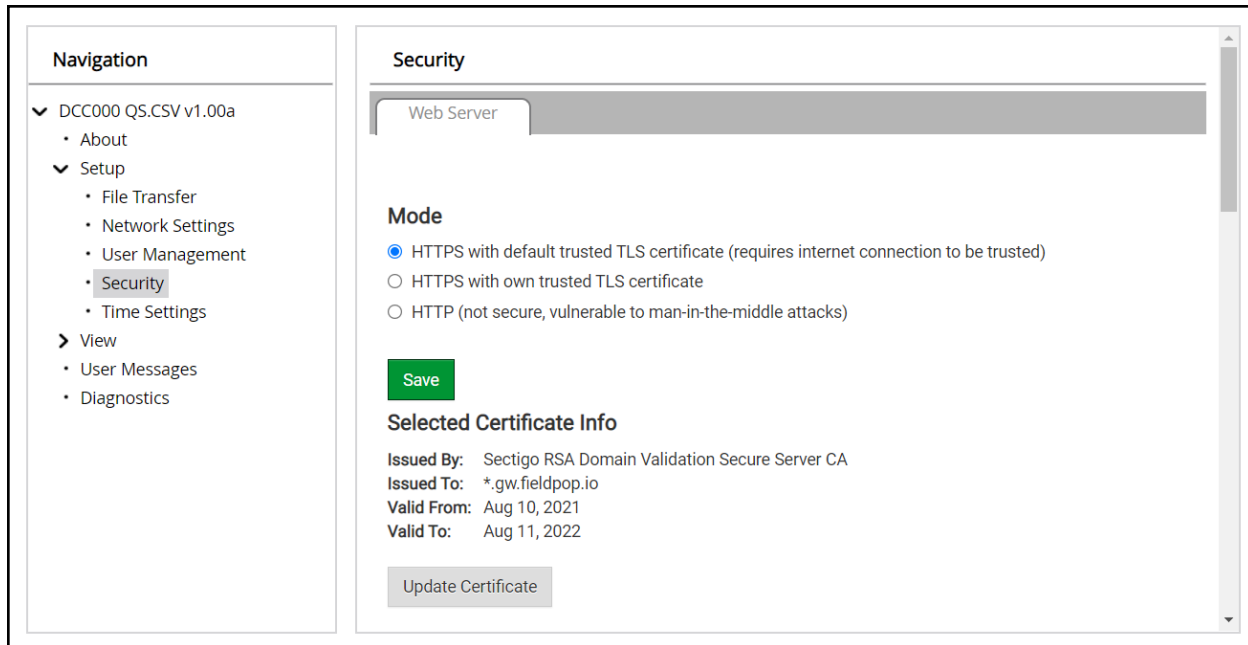

- Click the Edit Certificate button to open the certificate and key fields.
- Edit the loaded certificate or key text as needed.
- Click Save.

## 10.2 Change User Management Settings

- From the FS-GUI page, click Setup in the Navigation panel.
- Click User Management in the navigation panel.

**NOTE:** If the passwords are lost, the unit can be reset to factory settings to reinstate the default unique password on the label. For recovery instructions, see the [FieldServer Next Gen Recovery document](#). If the default unique password is lost, then the unit must be mailed back to the factory.

**NOTE:** Any changes will require a FieldServer reboot to take effect.

- Check that the Users tab is selected.

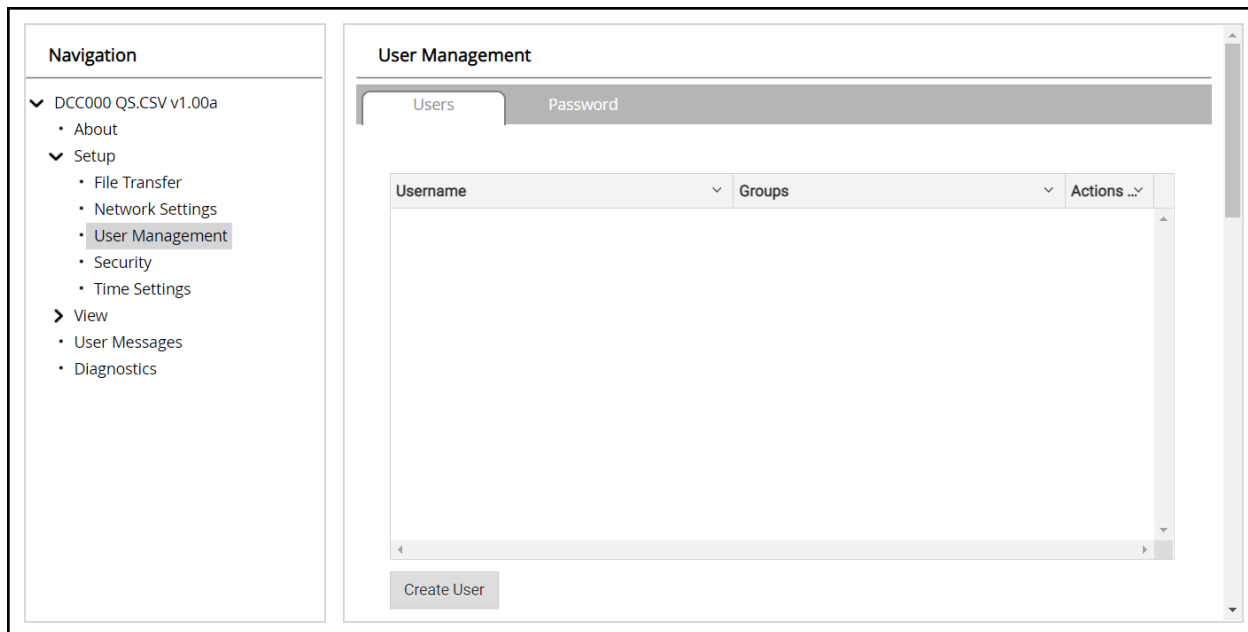

User Types:

**Admin** – Can modify and view any settings on the FieldServer.

**Operator** – Can modify and view any data in the FieldServer array(s).

**Viewer** – Can only view settings/readings on the FieldServer.

## 10.2.1 Create Users

- Click the Create User button.

**Create User**

**Username:**  
Enter a unique username

**Security Groups:**

- Admin
- Operator
- Viewer

**Password:** Weak  
Enter password

Show Passwords

**Confirm Password:**  
Confirm password

Generate Password

Create Cancel

- Enter the new User fields: Name, Security Group and Password.
  - **User details are hashed and salted**

**NOTE:** The password must meet the minimum complexity requirements. An algorithm automatically checks the password entered and notes the level of strength on the top right of the Password text field.

- Click the Create button.
- Once the Success message appears, click OK.

## 10.2.2 Edit Users

- Click the pencil icon next to the desired user to open the User Edit window.

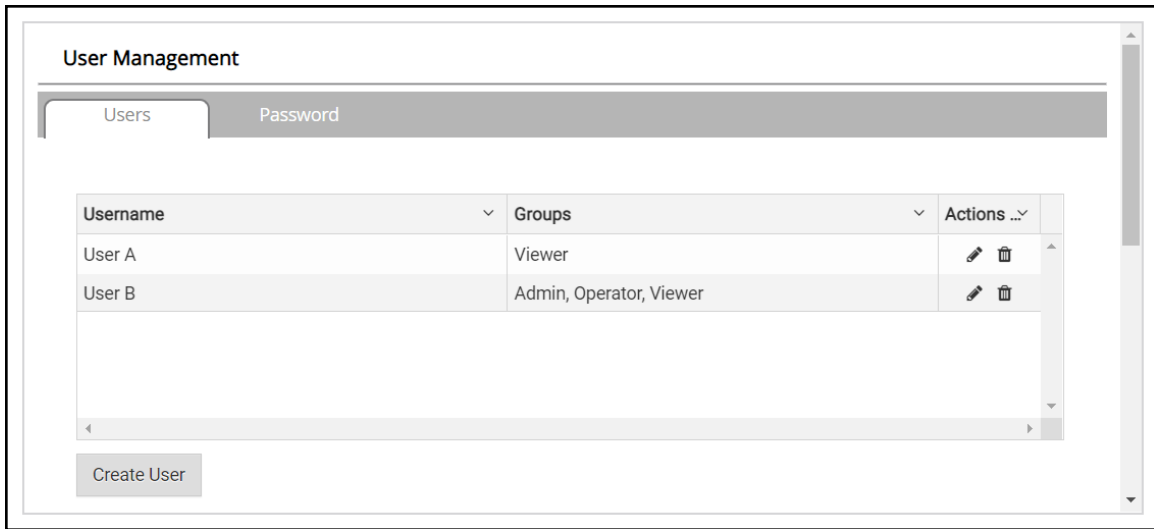

- Once the User Edit window opens, change the User Security Group and Password as needed.

The 'Edit User' dialog box is shown. It has the following fields and options:

- Username:** A text input field containing 'User A'.
- Security Groups:** Three checkboxes: 'Admin' (unchecked), 'Operator' (unchecked), and 'Viewer' (checked).
- Password:** A text input field containing 'Optional'.
- Show passwords
- Confirm Password:** A text input field containing 'Optional'.
- 
- (green)
- 

- Click Confirm.
- Once the Success message appears, click OK.

### 10.2.3 Delete Users

- Click the trash can icon next to the desired user to delete the entry.

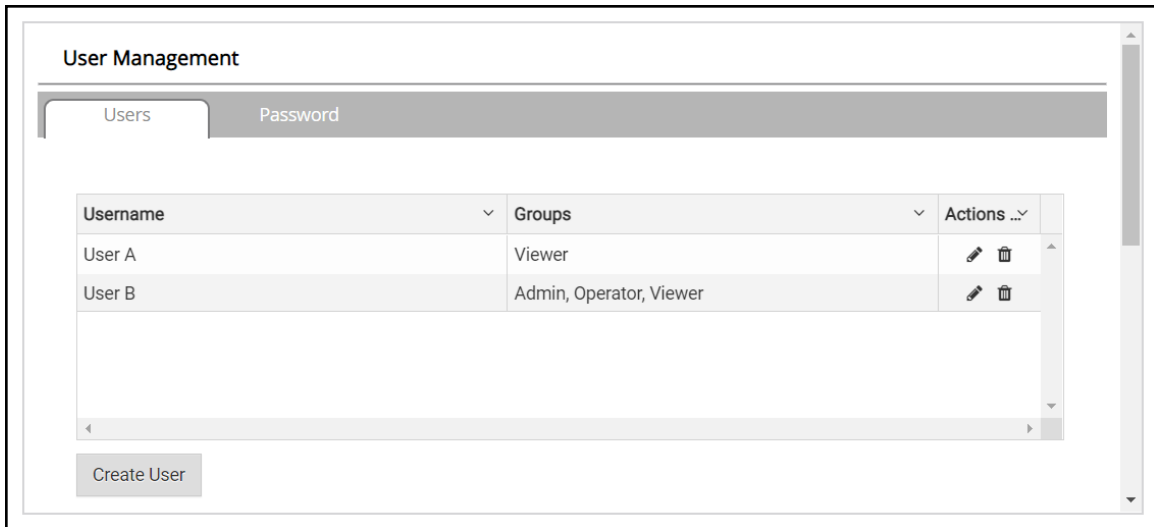

- When the warning message appears, click Confirm.

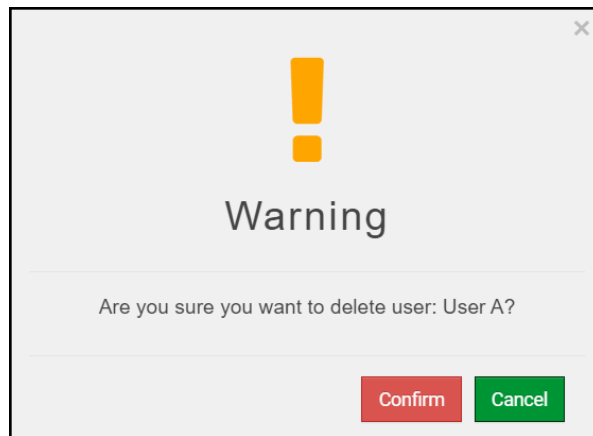

## 10.2.4 Change FieldServer Password

- Click the Password tab.

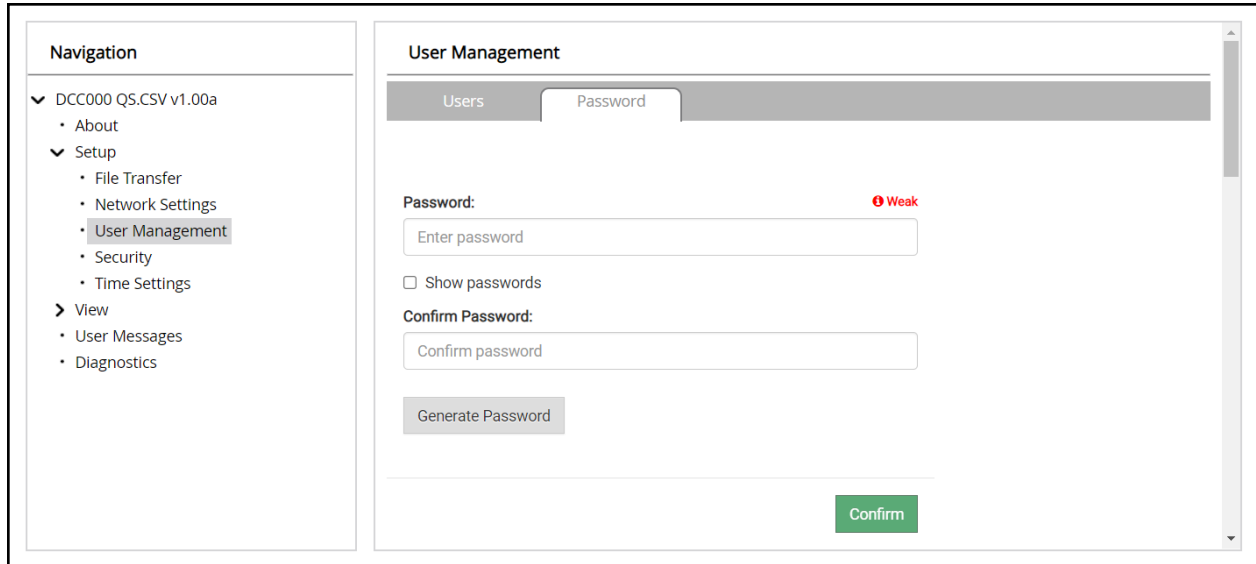

The screenshot shows a web interface with a navigation sidebar on the left and a main content area on the right. The sidebar, titled "Navigation", lists several menu items: "DCC000 QS.CSV v1.00a" (expanded), "About", "Setup" (expanded), "File Transfer", "Network Settings", "User Management" (highlighted), "Security", "Time Settings", "View" (expanded), "User Messages", and "Diagnostics". The main content area is titled "User Management" and has two tabs: "Users" and "Password". The "Password" tab is active. It contains a "Password:" label with a red "Weak" indicator and a "Show passwords" checkbox. Below these are two text input fields: "Enter password" and "Confirm password". A "Generate Password" button is located below the input fields. At the bottom right of the main content area is a green "Confirm" button.

- Change the general login password for the FieldServer as needed.

**NOTE:** The password must meet the minimum complexity requirements. An algorithm automatically checks the password entered and notes the level of strength on the top right of the Password text field.



### 10.3 Specifications



FS-QS-3XX0-F	
Electrical Connections	One 3-pin Phoenix connector with: RS-485/RS-232 (Tx+ / Rx- / gnd) One 3-pin Phoenix connector with: RS-485 (+ / - / gnd) One 3-pin Phoenix connector with: Power port (+ / - / Frame-gnd) Two Ethernet 10/100 BaseT port
Power Requirements	<i>Input Voltage:</i> 9-30VDC or 24VAC <i>Max Power:</i> 3 Watts <i>Current draw:</i> 24VAC 0.125A 9-30VDC 0.25A @12VDC
Approvals	FCC Part 15 C, UL 62368-1, CAN/CSA C22.2 No. 62368-1, EN IEC 62368-1, DNP 3.0 and Modbus conformance tested, BTL Marked, WEEE compliant, RoHS compliant, REACH compliant, UKCA and CE compliant, ODVA conformant, CAN ICES-003(B) / NMB-003(B)
Physical Dimensions	4 x 1.1 x 2.7 in (10.16 x 2.8 x 6.8 cm)
Weight	0.4 lbs (0.2 Kg)
Operating Temperature	-20°C to 70°C (-4°F to 158°F)
Humidity	10-95% RH non-condensing

**NOTE:** Specifications subject to change without notice.

### 10.4 Warnings

#### FCC Class B

**NOTE:** This equipment has been tested and found to comply with the limits for a Class B digital device, pursuant to part 15 of the FCC Rules. These limits are designed to provide reasonable protection against harmful interference in a residential installation. This equipment generates, uses and can radiate radio frequency energy and, if not installed and used in accordance with the instructions, may cause harmful interference to radio communications. However, there is no guarantee that interference will not occur in a particular installation. If this equipment does cause harmful interference to radio or television reception, which can be determined by turning the equipment off and on, the user is encouraged to try to correct the interference by one or more of the following measures:

- Reorient or relocate the receiving antenna.
- Increase the separation between the equipment and receiver.
- Connect the equipment into an outlet on a circuit different from that to which the receiver is connected.
- Consult the dealer or an experienced radio/TV technician for help.

## 10.5 Compliance with EN IEC 62368-1

For EN IEC compliance, the following instructions must be met when operating the QuickServer.

- The units shall be powered by listed LPS or Class 2 power supply suited to the expected operating temperature range.
- The interconnecting power connector and power cable shall:
  - Comply with local electrical code
  - Be suited to the expected operating temperature range
  - Meet the current and voltage rating for the FieldServer
- Furthermore, the interconnecting power cable shall:
  - Be of length not exceeding 3.05m (118.3")
  - Be constructed of materials rated VW-1, FT-1 or better
- If the unit is to be installed in an operating environment with a temperature above 65 °C, it should be installed in a Restricted Access Area requiring a key or a special tool to gain access.
- This device must not be connected to a LAN segment with outdoor wiring.

## **11 Limited 2 Year Warranty**

MSA Safety warrants its products to be free from defects in workmanship or material under normal use and service for two years after date of shipment. MSA Safety will repair or replace any equipment found to be defective during the warranty period. Final determination of the nature and responsibility for defective or damaged equipment will be made by MSA Safety personnel.

All warranties hereunder are contingent upon proper use in the application for which the product was intended and do not cover products which have been modified or repaired without MSA Safety's approval or which have been subjected to accident, improper maintenance, installation or application; or on which original identification marks have been removed or altered. This Limited Warranty also will not apply to interconnecting cables or wires, consumables or to any damage resulting from battery leakage.

In all cases MSA Safety's responsibility and liability under this warranty shall be limited to the cost of the equipment. The purchaser must obtain shipping instructions for the prepaid return of any item under this warranty provision and compliance with such instruction shall be a condition of this warranty.

Except for the express warranty stated above, MSA Safety disclaims all warranties with regard to the products sold hereunder including all implied warranties of merchantability and fitness and the express warranties stated herein are in lieu of all obligations or liabilities on the part of MSA Safety for damages including, but not limited to, consequential damages arising out of/or in connection with the use or performance of the product.