



PLX51-DL-232

Data Logger

Data Storage Module

Your Feedback Please

We always want you to feel that you made the right decision to use our products. If you have suggestions, comments, compliments or complaints about our products, documentation, or support, please write or call us.

How to Contact Us

ProSoft Technology, Inc.
+1 (661) 716-5100
+1 (661) 716-5101 (Fax)
www.prosoft-technology.com
support@prosoft-technology.com

PLX51-DL-232 User Manual
For Public Use.

June 22, 2022

ProSoft Technology®, is a registered copyright of ProSoft Technology, Inc. All other brand or product names are or may be trademarks of, and are used to identify products and services of, their respective owners.

Content Disclaimer

This documentation is not intended as a substitute for and is not to be used for determining suitability or reliability of these products for specific user applications. It is the duty of any such user or integrator to perform the appropriate and complete risk analysis, evaluation and testing of the products with respect to the relevant specific application or use thereof. Neither ProSoft Technology nor any of its affiliates or subsidiaries shall be responsible or liable for misuse of the information contained herein. Information in this document including illustrations, specifications and dimensions may contain technical inaccuracies or typographical errors. ProSoft Technology makes no warranty or representation as to its accuracy and assumes no liability for and reserves the right to correct such inaccuracies or errors at any time without notice. If you have any suggestions for improvements or amendments or have found errors in this publication, please notify us.

No part of this document may be reproduced in any form or by any means, electronic or mechanical, including photocopying, without express written permission of ProSoft Technology. All pertinent state, regional, and local safety regulations must be observed when installing and using this product. For reasons of safety and to help ensure compliance with documented system data, only the manufacturer should perform repairs to components. When devices are used for applications with technical safety requirements, the relevant instructions must be followed. Failure to use ProSoft Technology software or approved software with our hardware products may result in injury, harm, or improper operating results. Failure to observe this information can result in injury or equipment damage.

© 2022 ProSoft Technology. All Rights Reserved.



For professional users in the European Union

If you wish to discard electrical and electronic equipment (EEE), please contact your dealer or supplier for further information.



Warning – Cancer and Reproductive Harm – www.P65Warnings.ca.gov

Agency Approvals and Certifications

Please visit our website: www.prosoft-technology.com

Contents

Your Feedback Please	2
How to Contact Us.....	2
Content Disclaimer	2
Agency Approvals and Certifications.....	3
1 Preface	6
1.1 Introduction to the Data Logger	6
1.2 Features	6
1.3 Additional Information	8
2 Installation	9
2.1 Module Layout	9
2.2 Module Mounting	11
2.3 Power.....	12
2.4 RS232 Port	12
2.5 Ethernet Port.....	12
3 Setup	13
3.1 Install Configuration Software.....	13
3.2 Network Parameters	14
3.2.1 DHCP Server Settings	14
3.2.2 Network Settings.....	16
3.3 Creating a New Project.....	18
3.4 Configuring the PLX51-DL-232.....	20
3.4.1 General Tab	20
3.4.2 Serial Tab.....	21
3.5 Data Source Configuration	22
3.5.1 Group and Tag Triggers	22
3.5.2 Logix Source	23
3.5.3 DF1 Source.....	26
3.5.4 Modbus Source.....	27
3.6 Module Download	27
4 RSLogix 5000 Configuration	30
4.1 Add Module to I/O Configuration	30
4.2 Importing UDT's and Mapping Routines.....	32
4.3 RSLogix 5000 assemblies	35
4.3.1 Input Assembly	35
5 Diagnostics	37
5.1 LEDs	37
5.2 Module Status Monitoring	38
5.2.1 General Tab	40
5.2.2 Statistics tab.....	41

5.2.3	Tag Status Tab	42
5.2.4	Recent Records Tab	43
5.2.5	Record Management Tab	44
5.2.6	CIP Statistics Tab	45
5.2.7	Ethernet Clients Tab	46
5.2.8	TCP / ARP Tab	47
5.3	DF1 Packet Capture	48
5.4	Modbus Packet Capture	50
5.5	Module Event Log	53
5.6	Web Server	54
6 Technical Specifications		55
6.1	Dimensions	55
6.2	Electrical	56
6.3	Ethernet	56
6.4	Data Cache	57
6.5	Serial Port	57
6.6	DF1	57
6.7	Modbus	58
7 Support, Service & Warranty		59
7.1	Contacting Technical Support	59
7.2	Warranty Information	59

1 Preface

1.1 Introduction to the Data Logger

This manual describes the installation, configuration, operation, and diagnostics of the PLX51-DL-232. The PLX51-DL-232 can read and store data from Logix Controllers, DF1 Serial Interfaces, or Modbus devices. The PLX51-DL-232 has the capacity to store over 16 million records in its solid-state non-volatile memory. Each stored record includes a Date Time stamp with a 50 ms resolution, Tag Name, Data Type, and Value.

The PLX51-DL-232 can be used to log data at a remote site with limited communication with its base. The PLX51-DL-232 is also used to store records on mobile equipment such as trucks, drilling rigs, or snow plows. Once the equipment returns back to its base, the historical data can be uploaded and transferred to a more permanent storage device. The PLX51-DL-232 can also be configured to collect data which is only downloaded and examined if a fault occurs, otherwise the data is overwritten.

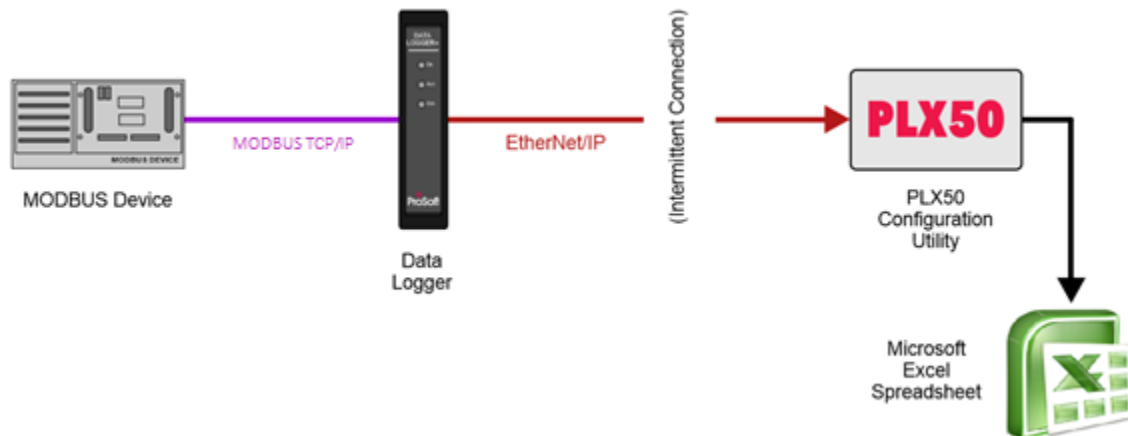

Figure 1.1. – Non-Historian Option

1.2 Features

The PLX51-DL-232 provides temporary extensive on-board storage capability for storing process tags. A total of 16,777,216 records can be stored in its non-volatile memory.

Each record consists of the following data:

Table 1.1. – Components of a Record

Parameter	Link
Date Time	UTC Time includes: Year, Month, Day, Hour, Minute, Second, Milliseconds. Time has a resolution of 50 milliseconds.
Tag Name	As defined in Controller or in the PLX50 Configuration Utility for other sources
Data Type	BOOL, SINT, INT, DINT, or REAL
Value	Logix Tag / DF1 File / Modbus Register value

The Log Index is managed by the PLX51-DL-232 and incremented each time a new record is stored. The Unload Index is managed externally by the unload service. It is only incremented after a record has been logged successfully to a text file. The records can be unloaded in Logix with the Example Code. Both the Log Index and Unload Indices loop around, eventually reaching the end of the cache. The cache becomes 100% full when the Log Index loops around and equals the Unload Index. In this situation, either older records are overwritten (Log Mode = Overwrite) or newer records are not logged (Log Mode = Hold).

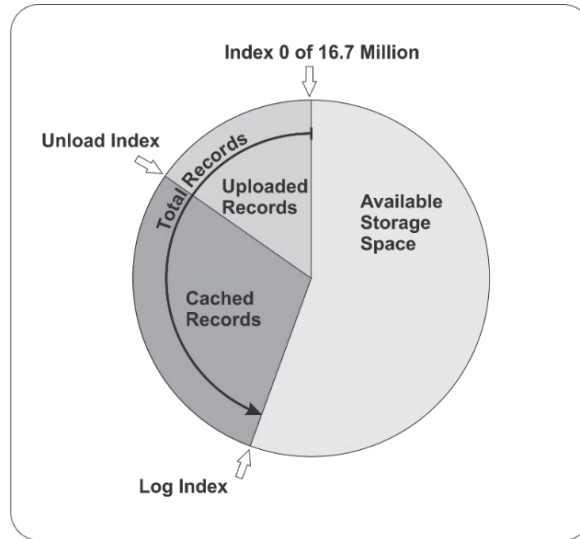

Figure 1.2. - Memory Schematic

The PLX51-DL-232 is configured using the ProSoft PLX50 Configuration Utility. This program can be downloaded from www.prosoft-technology.com, free of charge. The PLX50 Configuration Utility offers various configuration methods, including a controller tag browser. The PLX50 Configuration Utility can also be used to monitor the status and download historical data to a local file.

The PLX51-DL-232 can operate in both a Logix “owned” and standalone mode. With a Logix connection, the input and output assemblies provide additional diagnostics information. This information is available in the Logix controller environment.

The PLX51-DL-232 uses isolated RS232 for DF1 communication. The RS232 port also uses a terminal block for convenient installation.

A built-in webserver provides detailed diagnostics of system configuration and operation.

1.3 Additional Information

The following documents contain additional information that can assist you with installation and operation.

Table 1.2. - Additional Information

Resource	Link
PLX50 Configuration Utility Installation	www.prosoft-technology.com
User Manual Datasheet Example Code & UDTs	www.prosoft-technology.com
Ethernet wiring standard	www.cisco.com/c/en/us/td/docs/video/cds/cde/cde205_220_420/installation/guide/cde205_220_420_hiq/Connectors.html
CIP Routing	The CIP Networks Library, Volume 1, Appendix C:Data Management

2 Installation

2.1 Module Layout

The PLX51-DL-232 has three ports at the bottom of the enclosure, as shown in the figure below. The ports are used for Ethernet, RS232 serial, and power.

The DC power port uses a three-way connector (+ positive, - negative, and **Earth**).

The RS232 port uses a four-way connector (**Tx** Transmit, **Rx** Receive, **Gnd** Ground, and **Shield** earth connection).

The Ethernet cable must be wired according to industry standards which can be found in the additional information section of this document.



Figure 2.1. – Data Logger side and bottom view

The PLX51-DL-232 provides three diagnostic LEDs (**Ok**, **Act**, and **Eth**). These LEDs provide information on system operation, the Ethernet interface, and the auxiliary communication interface (RS232).

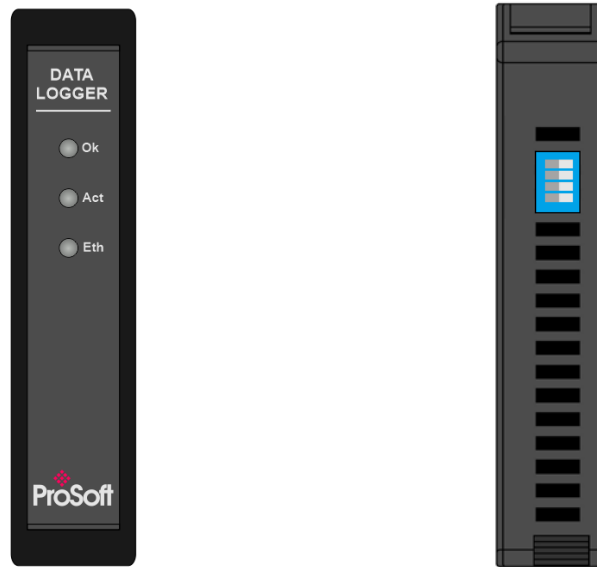

Figure 2.2. – Module front and top view

The PLX51-DL-232 has four DIP switches at the top of the enclosure as shown above.

Table 2.1. - DIP Switch Settings

DIP Switch	Description
DIP 1	Used to force the PLX51-DL-232 into "Safe Mode". When in "Safe Mode", the PLX51-DL-232 does not load the application firmware. It waits for new firmware to be downloaded. This should only be used when a firmware update was interrupted at a critical stage.
DIP 2	Used to force the PLX51-DL-232 into DHCP mode, useful when the user has forgotten the IP address of the PLX51-DL-232.
DIP 3	Reserved
DIP 4	Reserved

2.2 Module Mounting

The PLX51-DL-232 provides a DIN rail clip to mount onto a 35mm DIN rail.

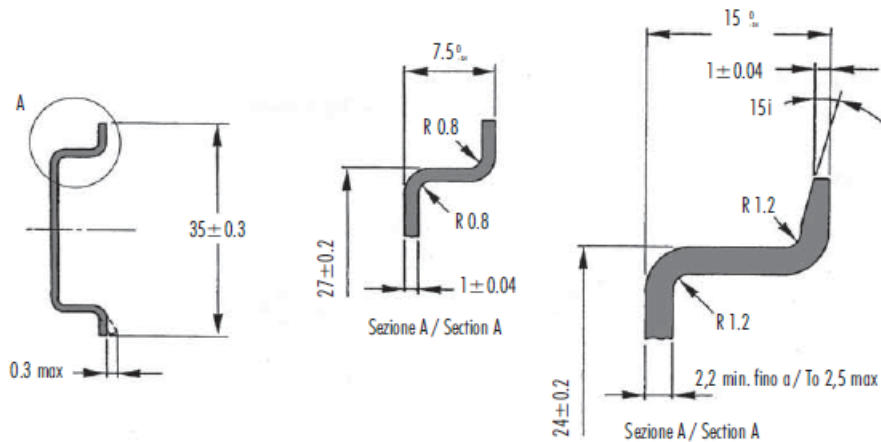

Figure 2.3. - DIN rail specification

The DIN rail clip is mounted on the bottom of the PLX51-DL-232. Use a flat screw driver to pull the clip downward. Once the PLX51-DL-232 is mounted onto the DIN rail, the clip must be pushed upward to lock the PLX51-DL-232 in place.

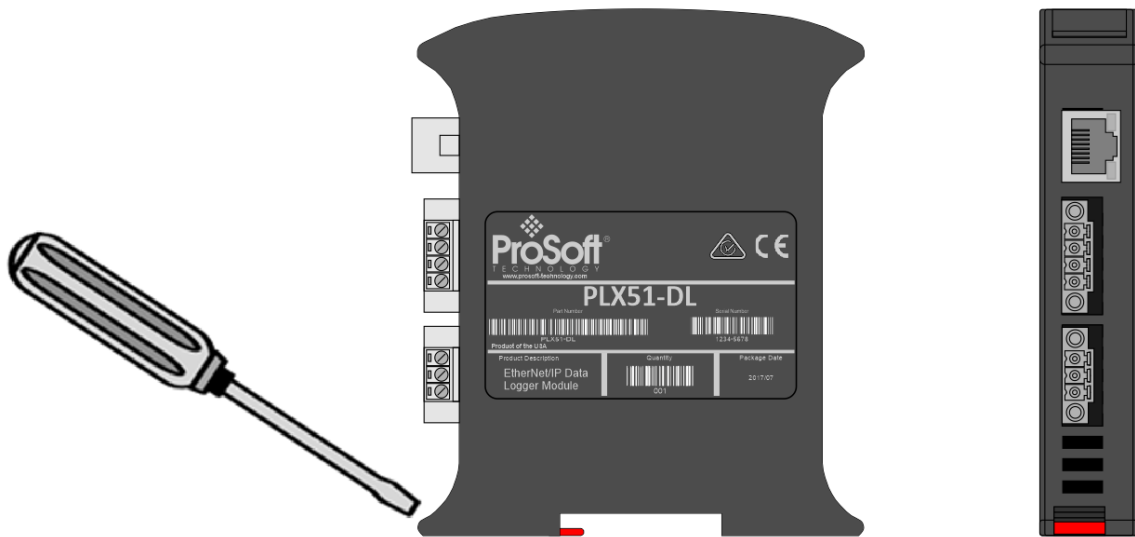

Figure 2.4. - DIN rail mouting

2.3 Power

A three-way power connector is used to connect + positive, - negative, and Earth. The PLX51-DL-232 requires an input voltage of 10 to 28 Vdc.

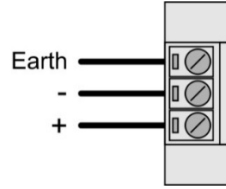

Figure 2.5. - Power connector

2.4 RS232 Port

The RS232 connector is used to connect the Transmit (Tx), Receive (Rx), and Ground conductors for serial communication. The shield terminal can be used for shielded cable in high noise environments.

Important: The shield of the RS232 port is internally connected to the power connector earth. Thus, when using a shield it is important to connect the Earth terminal on the power connector to a clean earth. Failing to do this can lower the signal quality of the RS232 communication.

Important: When using a shielded cable, it is important that only one end of the shield is connected to earth to avoid current loops. It is recommended to connect the shield to the PLX51-DL-232, and not to the other Serial device.

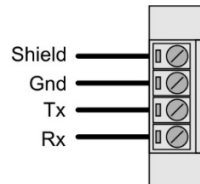

Figure 2.6. - RS232 connector

2.5 Ethernet Port

The Ethernet connector should be wired according to industry standards. Refer to the additional information section in this document for further details.

3 Setup

3.1 Install Configuration Software

The PLX51-DL-232 is configured using the PLX50 Configuration Utility environment. This software can be downloaded from www.prosoft-technology.com.



Figure 3.1. - PLX50 Configuration Utility Environment

3.2 Network Parameters

3.2.1 DHCP Server Settings

By default, the PLX51-DL-232 has DHCP (Dynamic Host Configuration Protocol) enabled. Thus, a DHCP server must be used to provide the PLX51-DL-232 with the required network parameters (IP address, subnet mask, etc.). There are a number of DHCP utilities available. However, it is recommended to use the DHCP server in the PLX50 Configuration Utility.

- 1 Within the PLX50 Configuration Utility, click on **TOOLS > DHCP SERVER**.

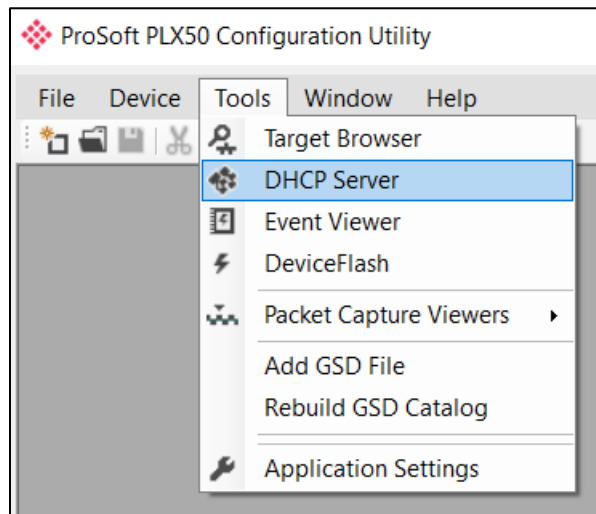

Figure 3.2. - Selecting DHCP Server

- 2 Once opened, the DHCP server listens on all available network adapters for DHCP requests and displays their corresponding MAC addresses.

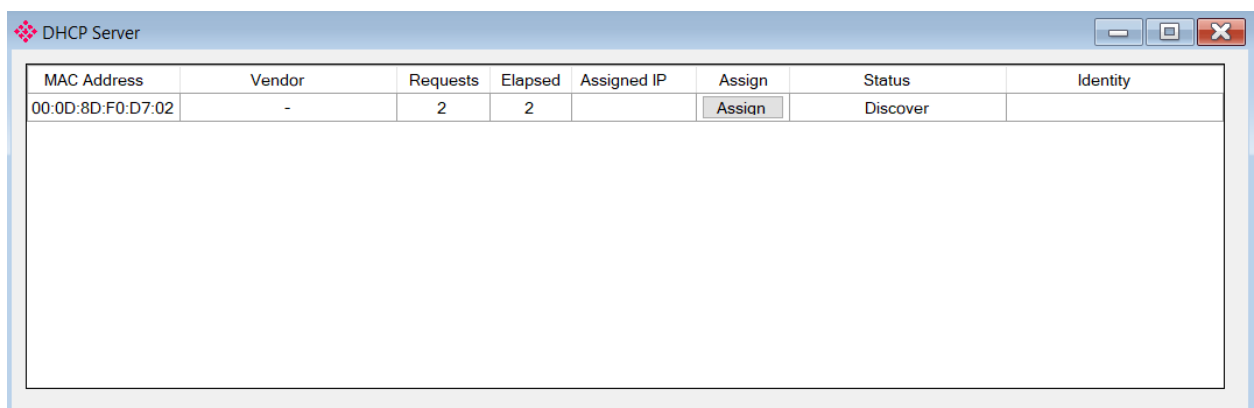

Figure 3.3. - DHCP Server

Note: If the DHCP requests are not displayed in the DHCP Server, it may be due to the local PC's firewall. During installation, the necessary firewall rules are automatically created for the Windows firewall. Another possibility is that another DHCP Server is operational on the network and it has assigned the IP address.

- 3 To assign an IP address, click on the corresponding **ASSIGN** button. The *Assign IP Address* dialog box opens.

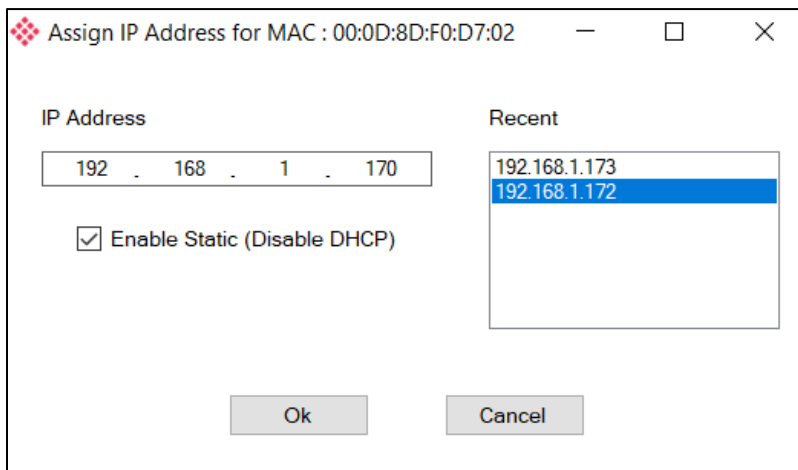

Figure 3.4. - Assigning IP Address

The required IP address can then be either entered, or a recently used IP address can be selected by clicking on an item in the *Recent* list.

If the *Enable Static* checkbox is checked, the IP address will be set to static after the IP assignment, thereby disabling future DHCP requests.

- 4 Click **OK** when complete.
- 5 Once the *Assign IP Address* dialog box has been accepted, the DHCP server automatically assigns the IP address to the PLX51-DL-232 and reads the *Identity Object Product* name from the device. The device indicates a green background upon successful assignment of the IP address.

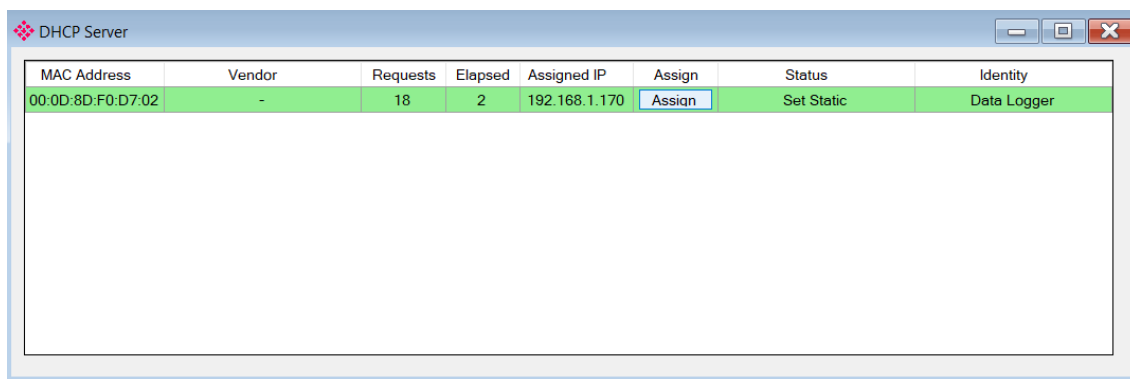

Figure 3.5. - Successful IP address assignment

It is possible to force the PLX51-DL-232 into DHCP mode by powering up the device with DIP switch 2 in the **On** position. A new IP address can then be assigned by repeating the previous steps.

Important: It is important to return DIP switch 2 back to Off position, to avoid the PLX51-DL-232 returning to a DHCP mode after the power is cycled again.

In addition to the setting the IP address, other network parameters can be set during the DHCP process. These settings can be viewed and edited by clicking on **TOOLS > APPLICATION SETTINGS**.

3.2.2 Network Settings

Once the DHCP process has been completed, the network settings can be set using the *Ethernet Port Configuration* via the *Target Browser*.

- 1 Click on Tools > Target Browser

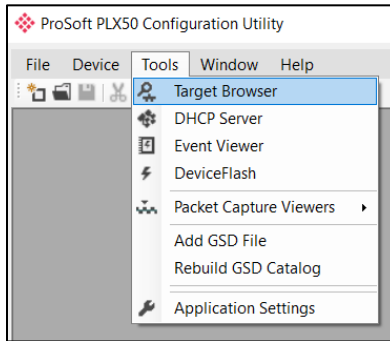

Figure 3.6. - Selecting the Target Browser

- 2 The *Target Browser* automatically scans the Ethernet network for EtherNet/IP devices.



Figure 3.7. - Target Browser

- 3 Right-clicking on a device reveals the context menu, including the *Port Configuration* option.

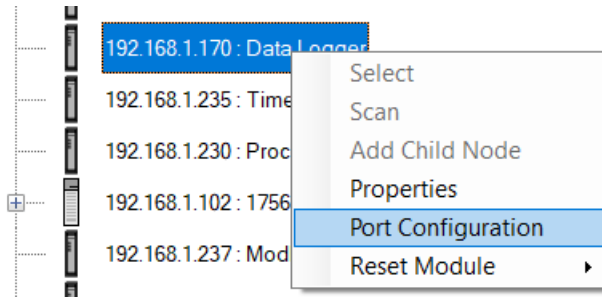

Figure 3.8. - Selecting Port Configuration

- 4 All relevant Ethernet port configuration parameters can be modified using the *Port Configuration* dialog box.

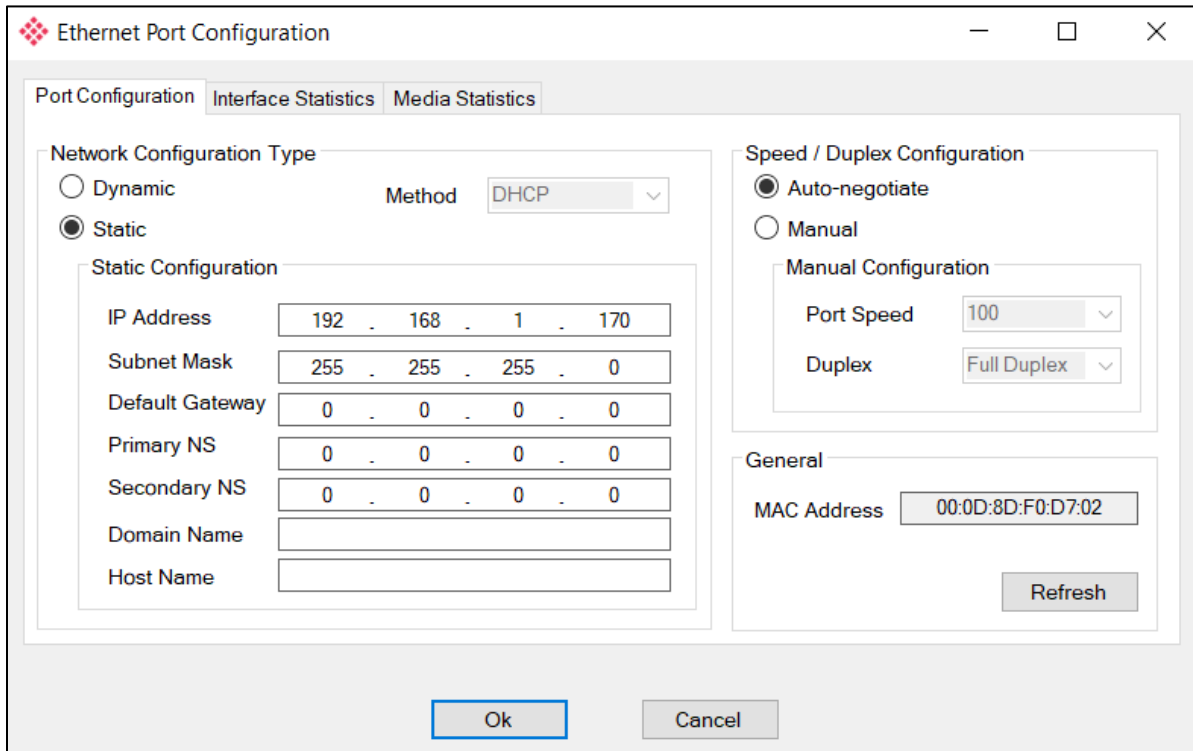

Figure 3.9. - Port Configuration

Alternatively, these parameters can be modified using the Rockwell Automation RSLinx software.

3.3 Creating a New Project

Before you configure the PLX51-DL-232, a new PLX50 Configuration Utility project must be created.

- 1 Click on **File > New**.

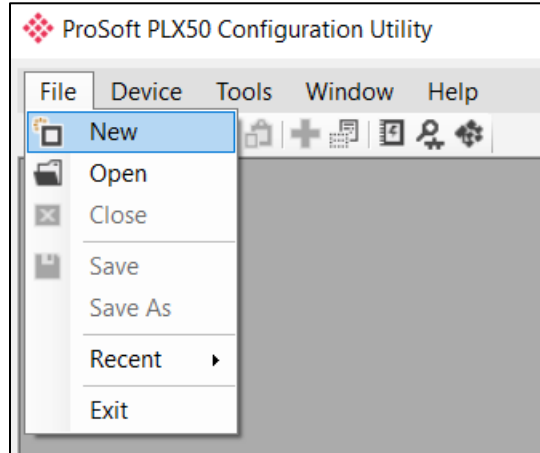

Figure 3.10. - Creating a new project

- 2 A new project is created and displayed in the Project Explorer tree view.
- 3 Add a new device by clicking on **DEVICE > ADD**.

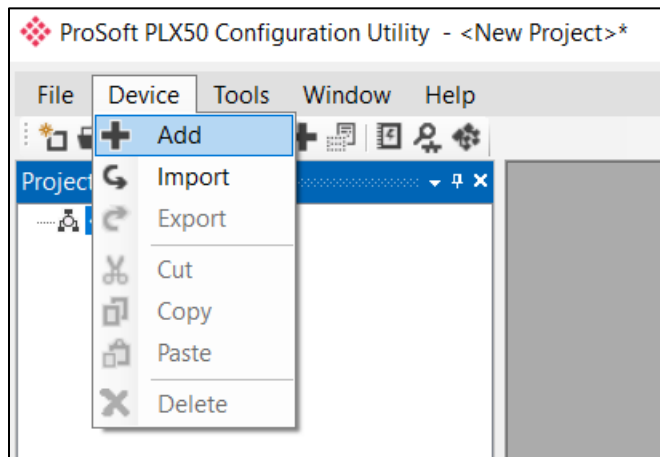

Figure 3.11 - Adding a new device

- 4 In the *Add New Device* dialog box, select the PLX51-DL-232 and click the **Ok** button.

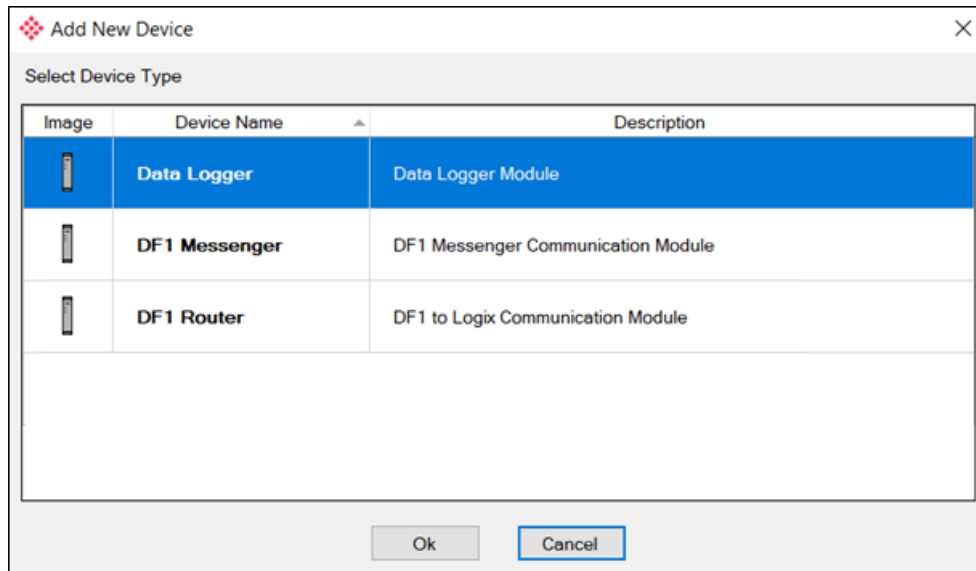

Figure 3.12 – Selecting a new PLX51-DL-232

- 5 The device appears in the Project Explorer tree, and its configuration window is opened. The device configuration window can also be opened by double-clicking the PLX51-DL-232 icon in the Project Explorer tree, or right-clicking the PLX51-DL-232 icon and selecting *Configuration*.

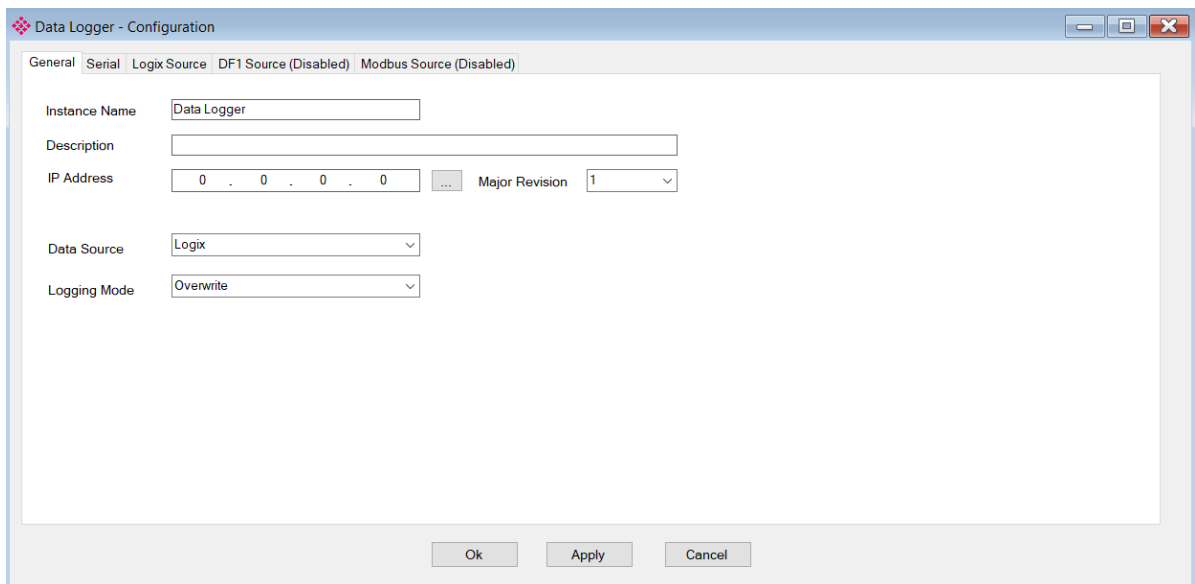

Figure 3.13 – PLX51-DL-232 configuration

3.4 Configuring the PLX51-DL-232

The PLX51-DL-232 is configured by the PLX50 Configuration Utility. The configuration consists of a general configuration, serial configuration for DF1 or Modbus RTU, data source configuration, and tag selections. The PLX51-DL-232 configuration is saved in non-volatile memory that persists when the PLX51-DL-232 is powered down.

Important: When a firmware upgrade is performed, the PLX51-DL-232 will clear all configuration and cached records.

3.4.1 General Tab

The general configuration is shown in the figure below. The general configuration window is opened by either double-clicking on the PLX51-DL-232 icon in the tree, or right-clicking the PLX51-DL-232 icon and selecting *Configuration*.

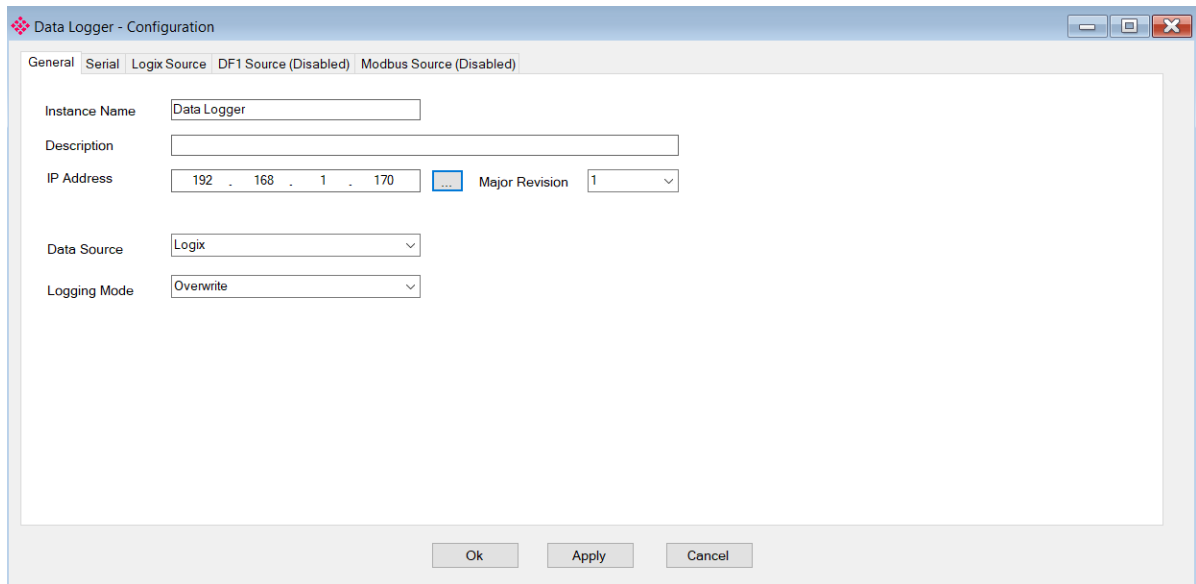

Figure 3.14 - General Configuration (Data Logger)

The general configuration consists of the following parameters:

Table 3.1 - General configuration parameters

Parameter	Description
Instance Name	This parameter is a user defined name to identify between various PLX51-DL-232's.
Description	This parameter is used to provide a more detailed description of the PLX51-DL-232.
Major Revision	The major revision of the PLX51-DL-232.
IP Address	The PLX51-DL-232's IP address used by the PLX50 Configuration Utility to communicate with the PLX51-DL-232.
Data Source	This parameter selects the source of the data. Logix – Rockwell Automation ControlLogix or Compact Logix controller DF1 – Serial DF1

Parameter	Description
	ModbusRTU – Serial Modbus ModbusTCP – Modbus over Ethernet
Logging Mode	This parameter determines if records are overwritten once the memory is filled. Overwrite = Old records are overwritten, giving priority to newer data. Hold = Old records are preserved while new records are not stored.

3.4.2 Serial Tab

The *Serial* tab is shown in the figure below. The Serial configuration is opened by either double-clicking on the PLX51-DL-232 icon in the tree, or right-clicking the PLX51-DL-232 icon and selecting *Configuration*. Select the *Serial* tab.

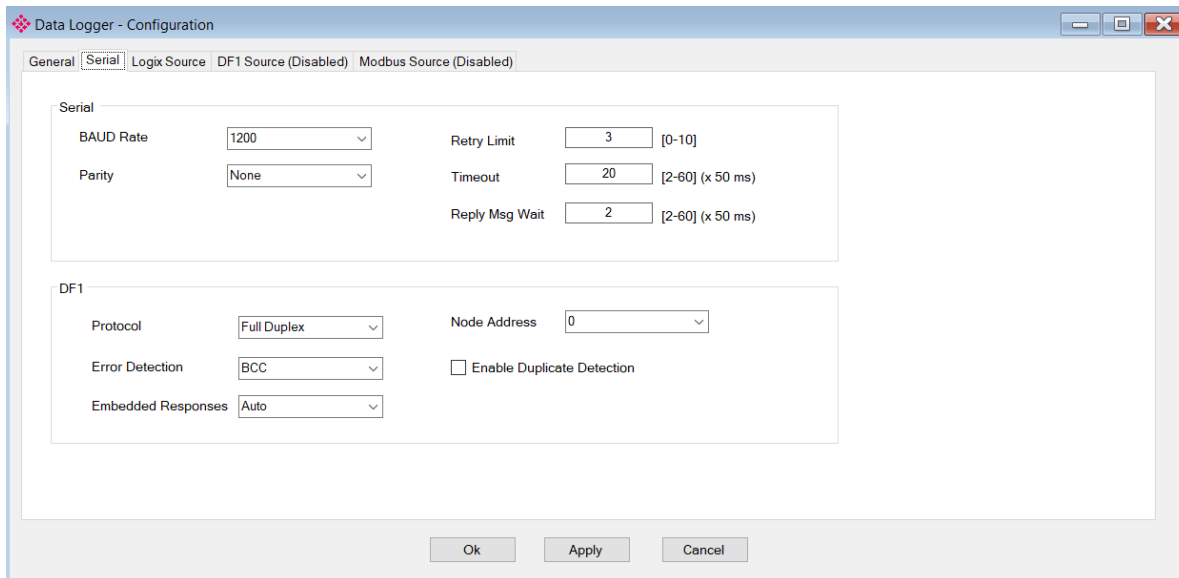

Figure 3.15 - Serial configuration

The Serial configuration (*Serial* tab) consists of general Serial and DF1-specific parameters. For Modbus RTU, only the *Baud Rate* and *Parity* need be configured.

Table 3.2 - Serial ModbusRTU and DF1 configuration parameters

Parameter	Description
Baud Rate	This configures the speed of the data that is sent across the RS232 serial network. The PLX51-DL-232 provides the following speeds: 1200, 2400, 4800, 9600, 19200, 38400, 57600, and 115200
Parity	This configures the parity of the RS232 serial port. The PLX51-DL-232 allows for Even, Odd, or None.
Protocol	This configures the PLX51-DL-232 to operate in full duplex or half duplex mode on the DF1 network.
Error Detection	The PLX51-DL-232 can be configured to perform either BCC or CRC checksum validation on incoming and outgoing packets. CRC checksums is a much stronger validation method, but is more processor-intensive to perform.
Embedded Response	This configures the PLX51-DL-232 to add the acknowledge responses in the data payload. It can be configured to be Auto Detect or On.

Parameter	Description
	This function is only available in Full Duplex mode.
Node Address	The node address is the local node address of the PLX51-DL-232.
Retry Limit	This determines how many times the PLX51-DL-232 must retry and message exchange before failing it.
Timeout	This determines the interval between retries for a failed message exchange.
Reply Msg Wait	This is the minimum delay before the DF1 reply is transmitted to the DF1 device.
Duplicate Detection	This configures the PLX51-DL-232 to check for duplicate packets and flagging them.

3.5 Data Source Configuration

The Data Source tabs determine the PLX51-DL-232 communication mode used to acquire data. The Data Source options include:

- *Logix Source* – ControlLogix and Compact Logix controllers
- *DF1 Source* – For collecting data over DF1 Serial communications
- *Modbus Source* – for ModbusRTU (Serial) and ModbusTCP (Ethernet) communications

Once the data source is selected, each tab allows the configuration of up to three source devices and a total of 200 tags.

Tags can be logged as a result of their individual log criteria **or** via a group trigger. There are eight trigger groups (A thru H), and a tag can be a member of any trigger group. Groups are in turn triggered by one or more tags. The triggering of a group ensures all its member's values are logged at the same instance.

3.5.1 Group and Tag Triggers

Three parameters determine when a tag is triggered:

- Delta Y (Δy) – A change in the value of the tag by this amount or more, **AND**
- Min ΔT – The minimum time in seconds between each consecutive trigger, **OR**
- Max ΔT – The maximum time between each consecutive trigger. Setting the Max ΔT to '0' disables the "heartbeat" and allows you to log on trigger.

The first two parameters work together to ensure tags are not logged too frequently, and the Max ΔT is set at a minimum logging frequency.

Logix Tag (max. of 200 items.)

	Target Name	Target Tag	Group Trigger	Group Member	Data Type	Digital Set	Δy	Min ΔT	Max ΔT
▶	Truck6	OutputRate			SINT		1	10	300
	Truck6	TankLevel			INT		10	60	300
	Truck6	Speed	A	AB	SINT		10	5	300
	Truck6	Direction		AB	REAL		10	30	300
	Truck6	Temp	B	B	REAL		3	60	300
	Truck6	Mix		B	SINT		1	20	300
	Truck6	Pressure	B	B	REAL		1	20	300
*									

Figure 3.16 – Group and Tag Triggers

3.5.2 Logix Source

The *Logix Source* tab is used to configure tags from Rockwell Automation Logix controllers over EtherNet/IP. The PLX51-DL-232 can read tags from up to three separate controllers. A *Target Name* must be provided. This acts as a reference to the Logix CIP path. The *Target Name* does not have to match the actual controller name set in RSLogix. The Controller's CIP Path can either be typed in or selected from a list in the *Target Browser*.

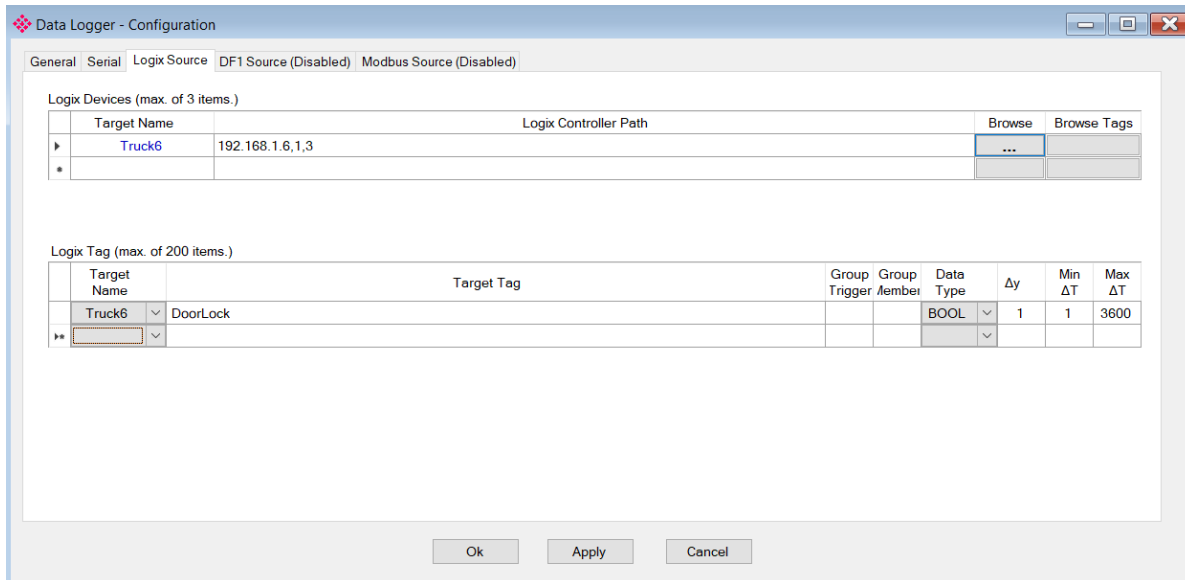

Figure 3.17 – Logix Source Configuration Tab

- Click the **BROWSE** button in the browse column to launch the *Target Browser*. The *Target Browser* opens and automatically scans for all available EtherNet/IP devices.

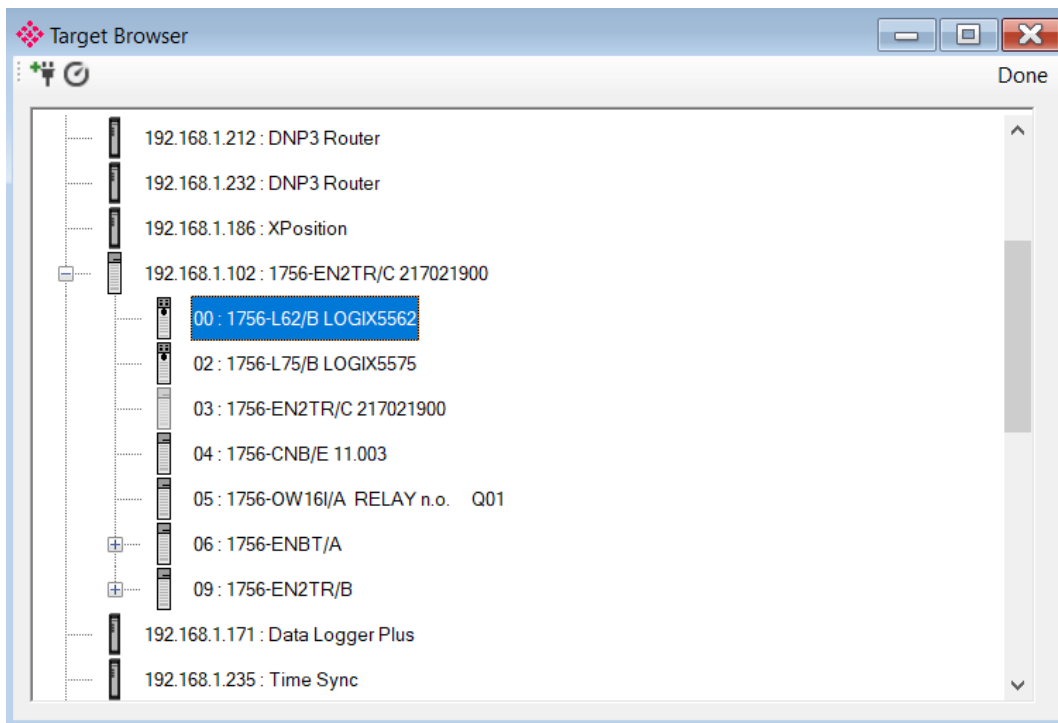

Figure 3.18 – Target Browser Window

- If the Ethernet/IP module is a bridge module, it can be expanded by right-clicking on the PLX51-DL-232 icon and selecting the *Scan* option.

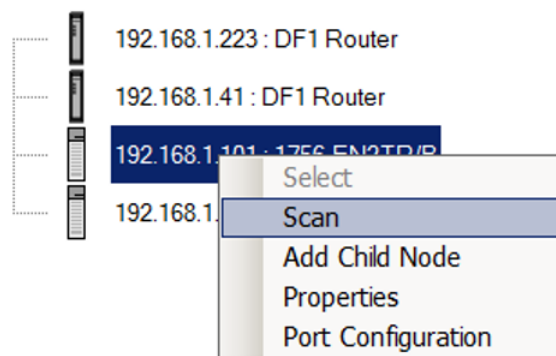

Figure 3.19 - Scanning node in the Target Browser

- The Logix controller can be selected by clicking the **Ok** button, or by double-clicking on the controller module.

- Once the controller references have been configured, the individual Logix tags can be added. Tags can either be entered manually or selected by using the *Tag Browser* associated with each controller.

Logix Tag (max. of 200 items.)

	Target Name	Target Tag	Group Trigger	Group Member	Data Type	Digital Set	Δy	Min ΔT	Max ΔT
▶	Truck6	DoorLock			BOOL	NO_YES	1	30	3600
	Truck6	RunTime			DINT		600	600	3600
	Truck6	Direction		A	REAL		5	30	1800
	Truck6	Speed	A	A	SINT		5	30	1800
*									

Figure 3.20 - Logix Tag configuration

Important: Tag names need to match in order for the PLX51-DL-232 to correctly identify the tag. Full tag names are needed for tags to be located in program scopes.

- To launch the *Tag Browser*, click the **BROWSE TAGS** button associated with the controller. Tags that are were already selected and identified are highlighted in green. See Fig 3.24.

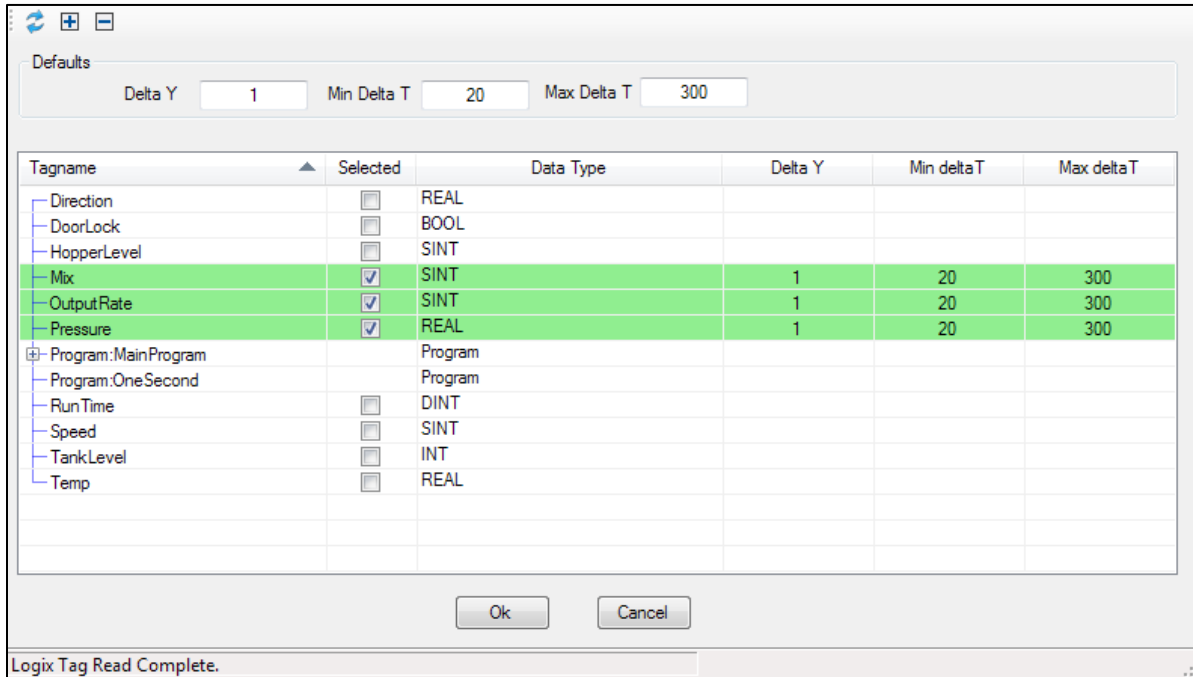

Figure 3.21 – Tag Browser Selection

- Tags can be removed by selecting the rows in the left margin, and right-clicking to display the **DELETE** option.

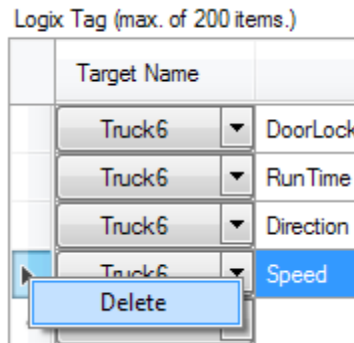

Figure 3.22 – Deleting Tags

3.5.3 DF1 Source

A maximum of three DF1 Sources can be configured. The configuration of each source requires a *Device Name* (used as a reference for tag data sources), the *Device Type* (either PLC5 or SLC), and a *Node Address*.

Each DF1 Tag requires a unique *Tagname* and *Data Address*.

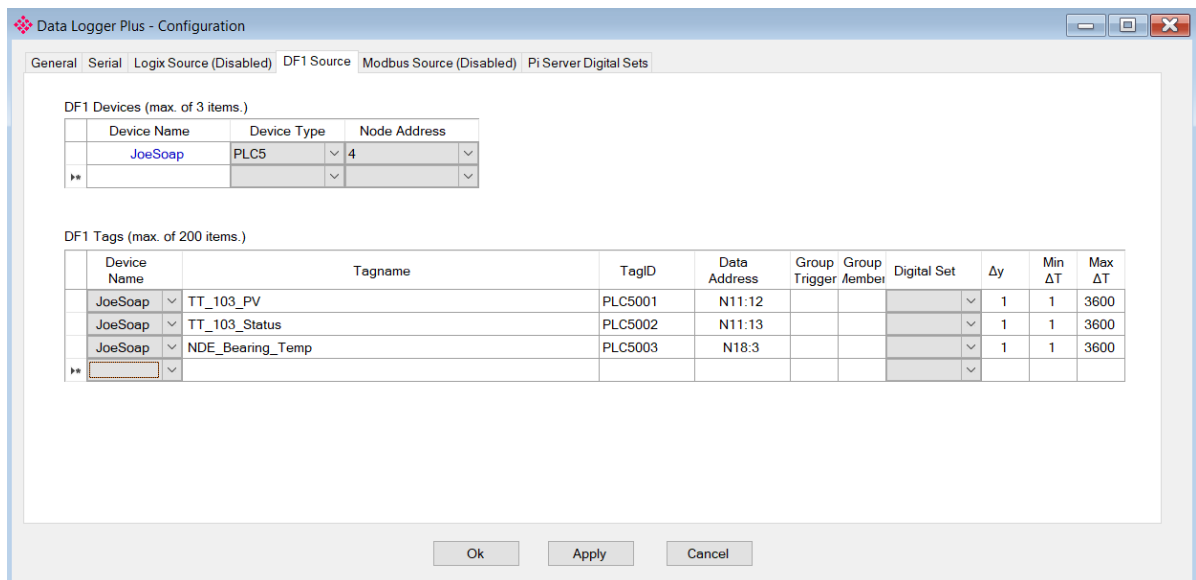

Figure 3.23 – DF1 Source configuration

3.5.4 Modbus Source

Both Modbus RTU and Modbus TCP/IP are configured using the *Modbus Source* tab. For Modbus RTU, a maximum of three Modbus sources can be configured. The configuration of each source requires a *Device Name* (used as a reference for tag data sources), the *IP Address* (Modbus TCP/IP only), and a *Node Address*.

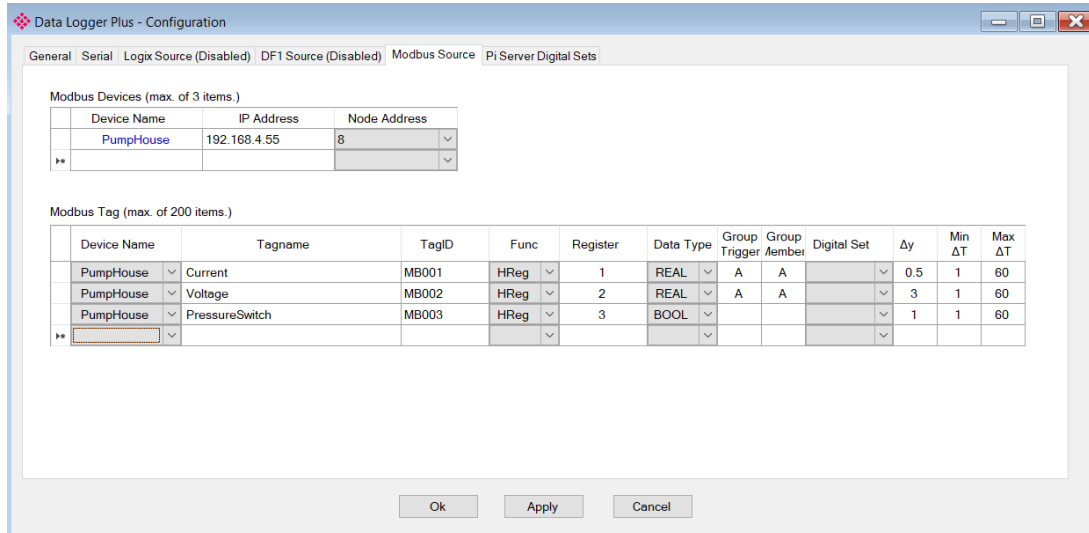

Fig 3.24 – Modbus Source Configuration

3.6 Module Download

Once the configuration is complete, it must be downloaded to the PLX51-DL-232.

Before downloading, the connection path of the PLX51-DL-232 should be set. This path automatically defaults to the PLX51-DL-232 IP address, as set in the PLX51-DL-232 configuration. It can be modified if the PLX51-DL-232 is not on a local network.

- 1 The connection path can be set by right-clicking on the PLX51-DL-232 icon and selecting the *Connection Path* option.

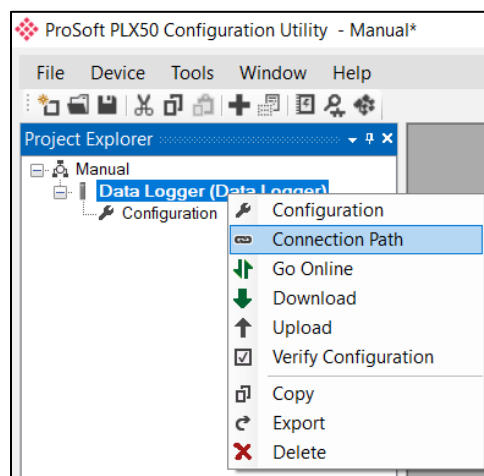

Fig 3.25 – Modbus Source Configuration

- The new connection path can be entered manually or selected by means of the *Target Browser*.

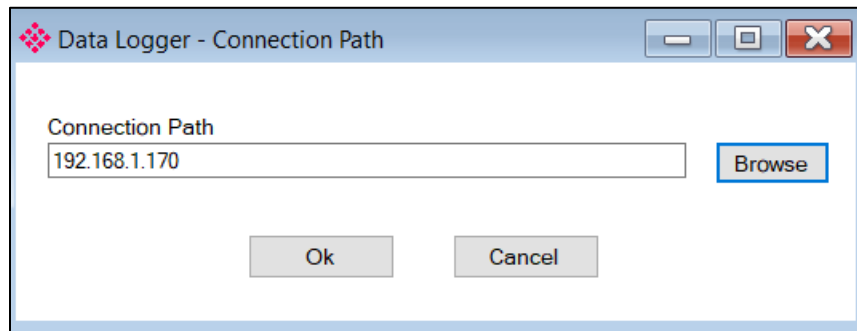

Figure 3.26 - Connection Path

- To initiate the download, right-click on the PLX51-DL-232 icon and select *Download*.

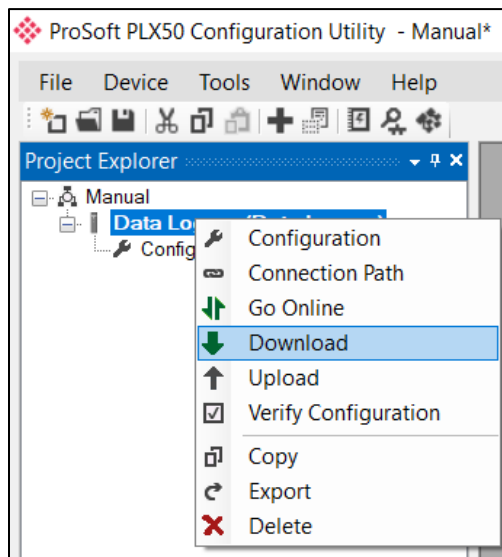

Figure 3.27 - Connection Path

- Once complete, you will be notified that the download was successful.

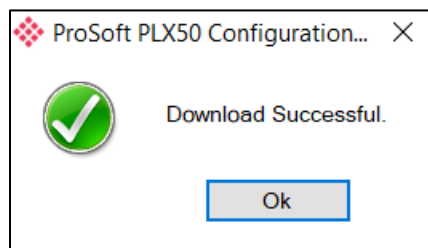

Figure 3.28 - Successful download

- 5 During the download process, the PLX51-DL-232's time will be compared to that of the PC's time. Should the difference be greater than 30 seconds, you will be prompted to set the PLX51-DL-232 time to that of the PC time.

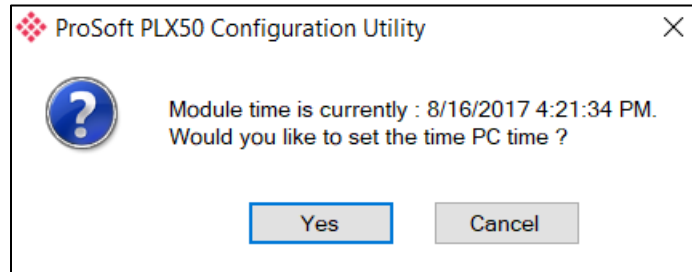

Figure 3.29 – Setting module time

- 6 The PLX51-DL-232 time is used only for the event log. Within the PLX50 Configuration Utility environment, the PLX51-DL-232 will be in the *Online* state, indicated by the green circle around the PLX51-DL-232 icon.

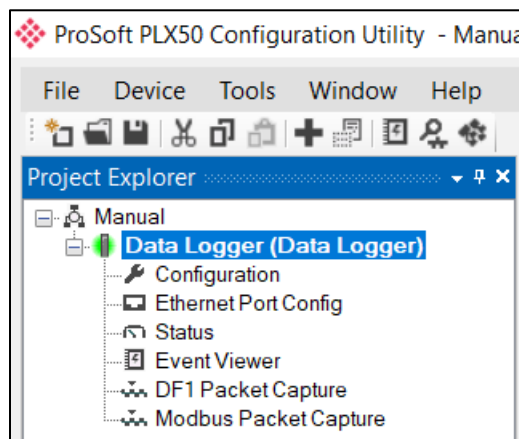

Figure 3.30 - Module Online

- 7 The PLX51-DL-232 is now configured.

4 RSLogix 5000 Configuration

4.1 Add Module to I/O Configuration

The PLX51-DL-232 can operate in both a Logix “owned” and standalone mode. When the PLX51-DL-232 operates in a Logix “owned” mode, the PLX51-DL-232 needs to be added to the RSLogix 5000 / Studio5000 IO tree, as a generic Ethernet module.

- 1 Right-click on the Ethernet Bridge in RSLogix 5000 and select *New Module*. Then select *ETHERNET-MODULE* and click **Ok**.

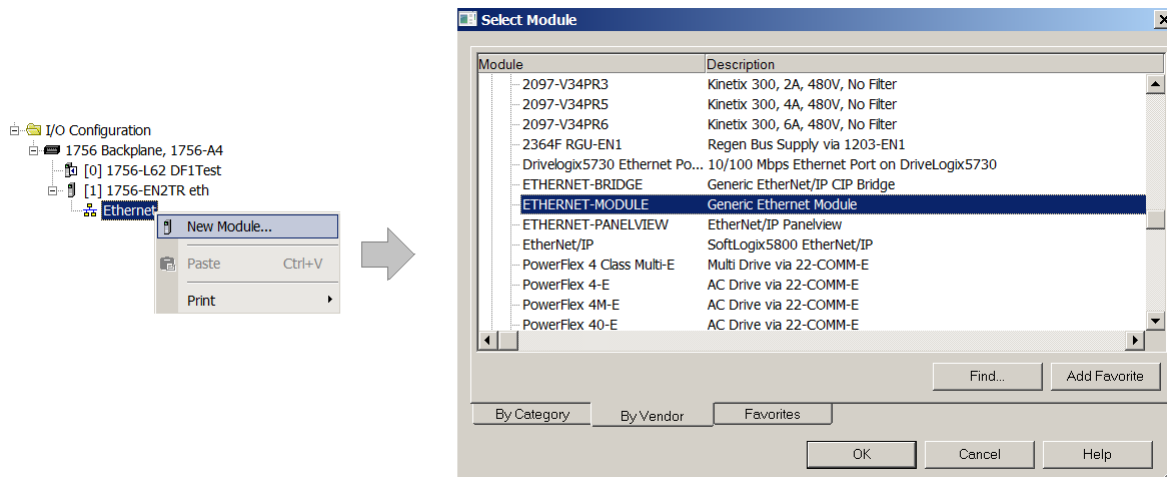

Figure 4.1 - Add a Generic Ethernet Module in RSLogix 5000

- 2 Enter the IP address of the PLX51-DL-232. The *Assembly Instance* and *Size* must also be added for the input, output, and configuration in the *Connection Parameters* section. Below are the required connection parameters.

Table 4.1 - RSLogix class 1 connection parameters for the Data Logger

Connection Parameter	Assembly Instance	Size
Input	103	29 (32-bit)
Output	104	1 (32-bit)
Configuration	102	0 (8-bit)

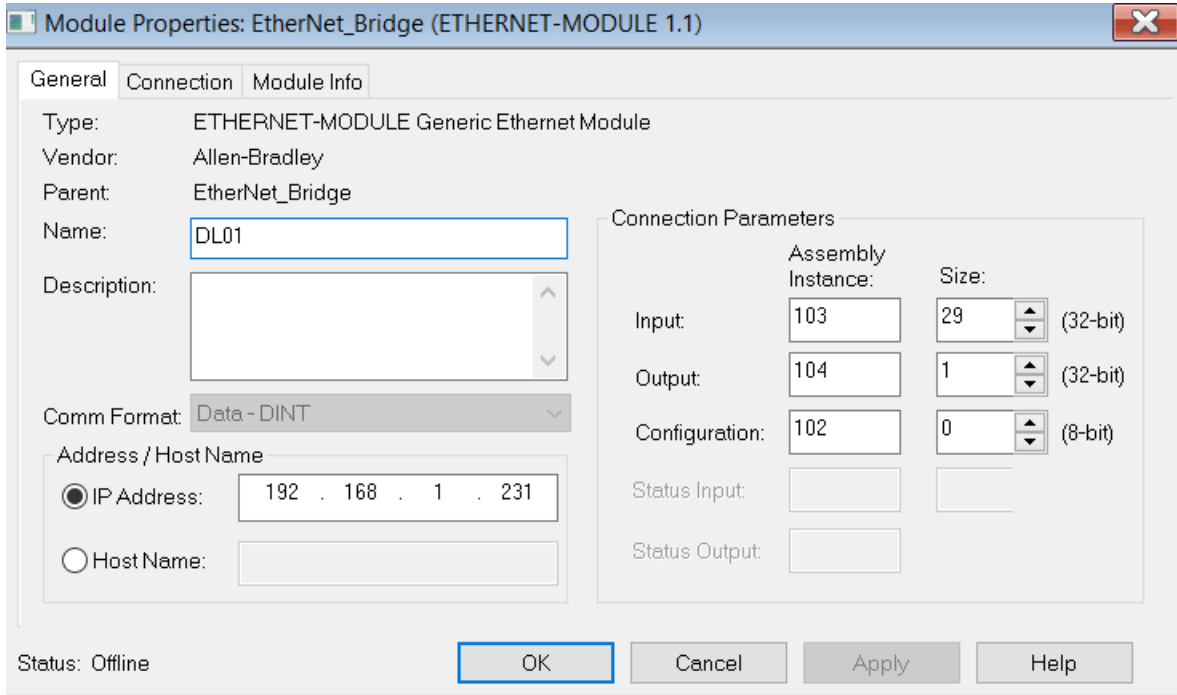

Figure 4.2 - RSLogix General module properties in RSLogix 5000

- 3 Add the connection requested packet interval (RPI). This is the rate at which the input and output assemblies are exchanged. The recommended value is 500 ms. Refer to the technical specification section in this document for further details on the limits of the RPI.

Important: Although the PLX51-DL-232 is capable of running with an RPI of 10 ms, it is recommended to set the RPI to 500 ms to avoid unnecessary overloading of the PLX51-DL-232 processor.

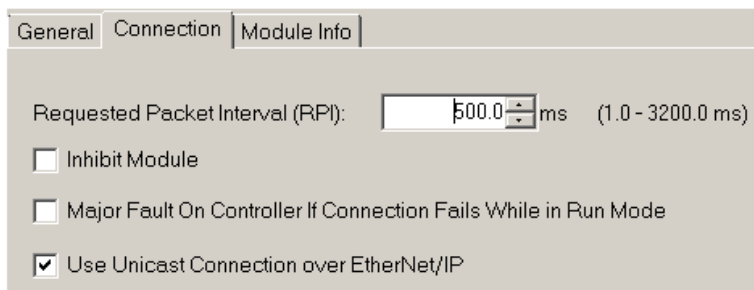

Figure 4.3 - Connection module properties in RSLogix 5000

- Once the PLX51-DL-232 has been added to the RSLogix 5000 IO tree, assign the User Defined Types (UDTs) to the input and output assemblies. You can import the required UDTs by right-clicking on the *User-Defined* sub-folder in the *Data Types* folder and selecting *Import Data Type*. The assemblies are then assigned to the UDTs with a ladder copy instruction (COP).

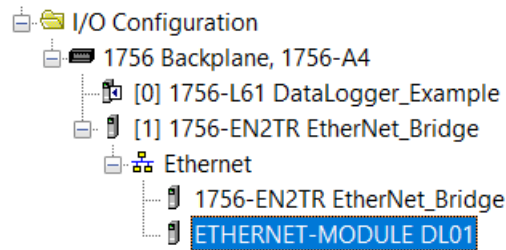

Figure 4.4 – RSLogix 5000 I/O module tree

4.2 Importing UDT's and Mapping Routines

To simplify the mapping of the input image, an RSLogix 5000 Routine Partial Import (.L5X) file is provided.

- Right-click on the required Program and select the *Import Routine* option.

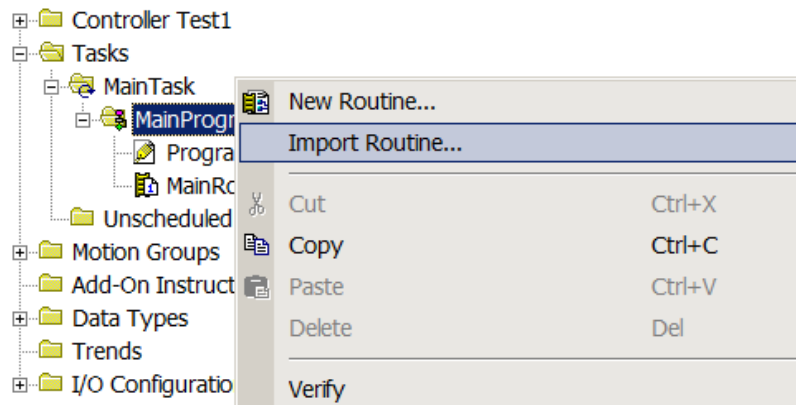

Figure 4.5 – RSLogix 5000 Importing Data Logger specific routine and UDTs

2 Select the proper .L5X file.

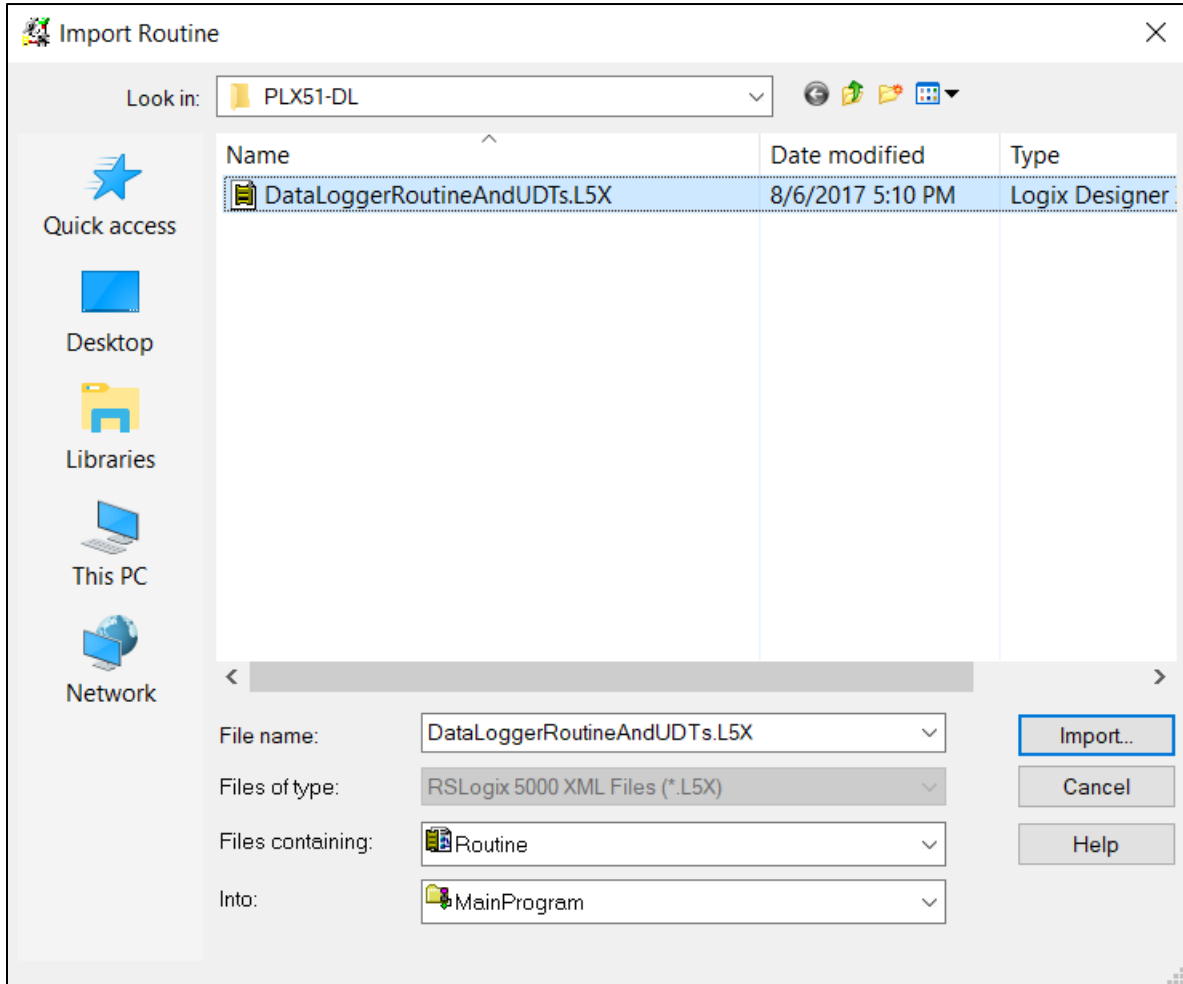

Figure 4.6 - Selecting partial import file

The import creates the following:

- The required UDTs (user defined data types)
- Controller tags representing the Input Assembly.
- A routine mapping the PLX51-DL-232 to the aforementioned tag.

- 3 You may need to change the routine to map to the correct PLX51-DL-232 instance name. Make sure that the mapping routine is called by the Program's Main Routine.

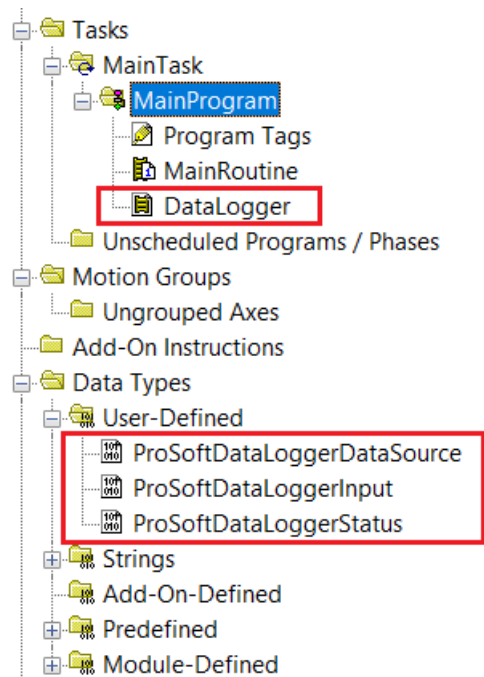

Figure 4.7 - Imported RSLogix 5000 objects

Refer to the Additional Information section of this document for an RSLogix 5000 project example, as well as the required UDTs.

4.3 RSLogix 5000 assemblies

When the PLX51-DL-232 operates in a Logix “owned” mode, the Logix controller establishes a class 1 cyclic communication connection with the PLX51-DL-232. An input assembly is exchanged at a fixed interval. The provided UDTs convert the input arrays into tag-based assemblies. Refer to the Additional Information section in this document for more information on the input UDTs. There are no Output or Configuration assemblies.

[-] DataLoggerInput	{...}	{...}		ProSoftDataLoggerInput
+ DataLoggerInput.Instance		''	{...}	STRING
[-] DataLoggerInput.Status	{...}	{...}		ProSoftDataLoggerStatus
[-] DataLoggerInput.Status.Running		1		Decimal BOOL
[-] DataLoggerInput.Status.ConfigurationValid		0		Decimal BOOL
[-] DataLoggerInput.Status.ContinuousLogging		0		Decimal BOOL
[-] DataLoggerInput.Status.LoggingInhibited		0		Decimal BOOL
[-] DataLoggerInput.Status.LoggingStopped		0		Decimal BOOL
[-] DataLoggerInput.CachePercentageUsed		0.0		Float REAL
+ DataLoggerInput.CacheRecordCount		0		Decimal DINT
+ DataLoggerInput.TotalRecordCount		0		Decimal DINT
+ DataLoggerInput.ActiveTagCount		0		Decimal DINT
[-] DataLoggerInput.DataSource	{...}	{...}		ProSoftDataLoggerDataSource
[-] DataLoggerInput.DataSource.EtherNetIP		1		Decimal BOOL
[-] DataLoggerInput.DataSource.DF1		1		Decimal BOOL
[-] DataLoggerInput.DataSource.ModbusRTU		1		Decimal BOOL
[-] DataLoggerInput.DataSource.ModbusTCP		1		Decimal BOOL
+ DataLoggerInput.DataSourceReadCount		0		Decimal DINT

Figure 4.8 - Input assembly UDT structure

4.3.1 Input Assembly

The following parameters are used in the input assembly of the PLX51-DL-232.

Table 4.2 - RSLogix 5000 input assembly parameters

Parameter	Datatype	Description
Instance	STRING	Instance name of the PLX51-DL-232 that was configured under the <i>General Configuration</i> tab in the PLX50 Configuration Utility.
Status.Running	BOOL	Set if the PLX51-DL-232 has a valid configuration and is reading tags.
Status.ConfigValid	BOOL	Set if a valid configuration is executing in the PLX51-DL-232.
Status.ContinuousLogging	BOOL	Set if <i>Logging Mode</i> is set to Overwrite, clear for Hold.
Status.ConfigurationValid	BOOL	Set if a valid configuration is executing in the PLX51-DL-232.
Status.LoggingInhibited	BOOL	Not Used.
Status.LoggingStopped	BOOL	Not Used.
CachePercentage	REAL	The number of cached records not yet uploaded, as a percentage of the total record capacity of 16,777,216.
CacheRecordCount	DINT	The number of cached records not yet uploaded.
TotalRecordCount	DINT	The total number of cached records uploaded or not.
ActiveTagCount	DINT	The number of individual tags configured to be read.
DataSource.EtherNetIP	BOOL	Set if the data source is set to Logix.
DataSource.DF1	BOOL	Set if the data source is set to DF1.

Parameter	Datatype	Description
DataSource.ModbusRTU	BOOL	Set if the data source is set to Modbus RTU.
DataSource.ModbusTCP	BOOL	Set if the data source is set to Modbus TCP/IP.
DataSourceReadCount	DINT	The number of tag reads from the configured data source.

Important: The PLX51-DL-232 can poll single BOOL tags only. It cannot poll from an array of BOOL's.

5 Diagnostics

5.1 LEDs

The PLX51-DL-232 provides three LEDs for diagnostics purposes as shown below.

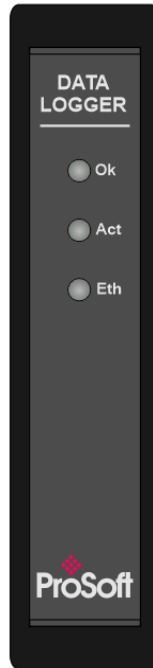

Figure 5.1 - Data Logger front view

Table 5.1 - Module LED operation

LED	Description
Ok	<p>The Ok LED provides information of the system-level operation of the PLX51-DL-232.</p> <p>If the LED is green, then the PLX51-DL-232 has booted and is running correctly.</p> <p>If the LED is red, then the PLX51-DL-232 is not operating correctly. For example, if the PLX51-DL-232 application firmware has been corrupted or there is a hardware fault, Ok LED will be red.</p>
Act	<p>The Act LED is used for the RS232 serial port. For every successful received DF1 or Modbus-RTU packet, the Act LED toggles green. The LED toggles red if a corrupted packet is received (eg. failed checksum).</p>
Eth	<p>The Eth LED illuminates when an Ethernet link is detected (by plugging in a connected Ethernet cable). The LED flashes when traffic is detected.</p>

5.2 Module Status Monitoring

The PLX51-DL-232 provides a range of statistics that can assist with module operation, maintenance, and troubleshooting. The statistics can be accessed by the PLX50 Configuration Utility or using the PLX51-DL-232 web server.

- 1 To view the PLX51-DL-232's status in the PLX50 Configuration Utility, the PLX51-DL-232 must be online. If the PLX51-DL-232 is not Online (following a recent configuration download), right-click on the PLX51-DL-232 icon and select the *Go Online* option.

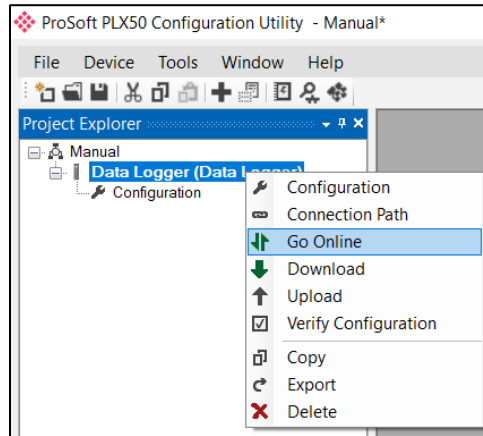

Figure 5.2 - Selecting to Go Online

- 2 The *Online* mode is indicated by the green circle behind the PLX51-DL-232 in the Project Explorer tree.

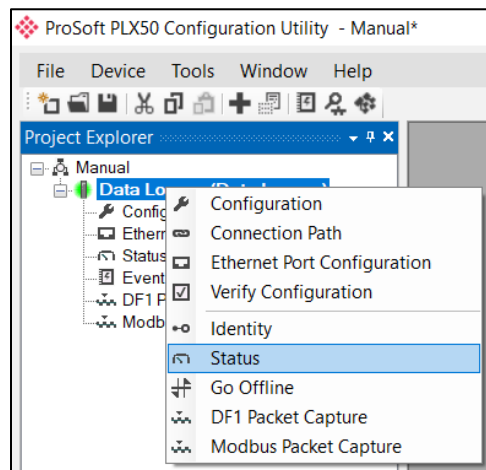

Figure 5.3 - Selecting online Status

- 3 The *Status* window is opened by either double-clicking on the *Status* option in the Project Explorer tree, or by right-clicking on the PLX51-DL-232 icon and selecting *Status*.

- 4 The *Status* window contains multiple tabs to display the current status of the PLX51-DL-232.

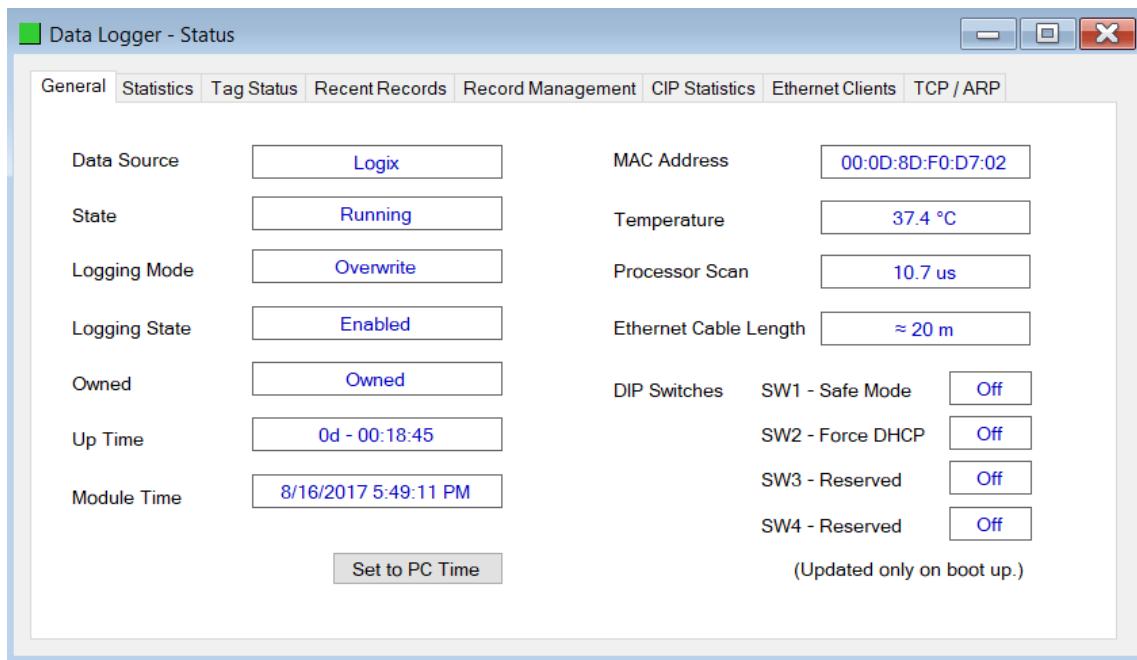

Figure 5.4 - Status monitoring - General

5.2.1 General Tab

The *General* tab displays the following general parameters as well as setting the PLX51-DL-232 time to the PC time:

Table 5.2 - Parameters displayed in the Status Monitoring – General Tab

Parameter	Description
Data Source	Logix, DF1, Modbus RTU, Modbus TCP/IP
State	This is the current state of the module. Running The module is reading tags and logging to the log. Stopped The module is idle and not reading tags or logging data.
Logging Mode	Hold or Overwrite – determines if records are overwritten when the cache is full.
Logging State	This is the current state of the logging in the module. Running Data is being read from the source and logged if the criteria is met. Running Rollover Data is being read from the source and logged if the criteria is met. In this state the event index has rolled over at least once. Inhibited The module has stopped reading and logging data, because the user has inhibited it from Logix. Stopped The module has stopped logging data, because it has reached maximum events and the module is set to not overwrite.
Owned	Indicates whether or not the PLX51-DL-232 is currently owned (Class 1) by a Logix controller.
Up Time	Indicates the elapsed time since the PLX51-DL-232 was powered up.
Module Time	Indicates the PLX51-DL-232's internal time. The PLX51-DL-232 time is stored in UTC (Universal Coordinate Time) but displayed on this page according to the local PC Time Zone settings
MAC Address	Displays the PLX51-DL-232's unique Ethernet MAC address.
Temperature	Internal temperature of the PLX51-DL-232.
Processor Scan	Amount of time (microseconds) taken by the PLX51-DL-232's processor in the last scan.
DIP Switch Position	Status of the DIP switches when the PLX51-DL-232 booted. Note that this status will not change if the DIP switches are altered when the PLX51-DL-232 is running.

5.2.2 Statistics tab

The *Statistics* tab displays the statistics of the record cache and data source.

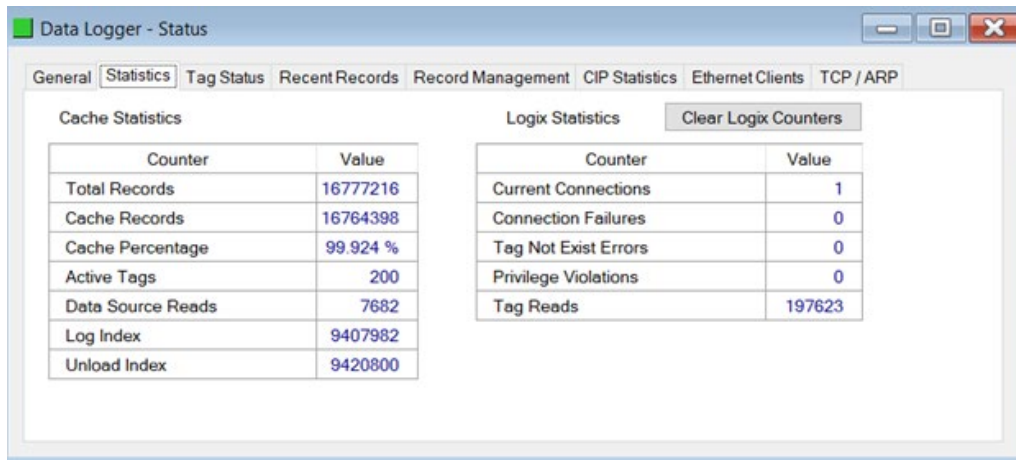

Figure 5.5 - Status monitoring - Transactions

Table 5.3 – Cache Statistics

Statistic	Description
Total Records	The total number of cached records, uploaded or not.
Cache Records	The number of cached records not yet uploaded.
Cache Percentage	The number of cached records not yet uploaded, as a percentage of the total record capacity of 16,777,216.
Active Tags	The number of individual tags configured to be read.
Data Source Reads	The number of tag reads from the configured data source.
Log Index	The current record index being written to.
Unload Index	The upload record index. Managed by the Unload Service.

Table 5.4 – Logix statistics

Statistic	Description
Current Connections	The number of current open class 3 connections.
Connection Failures	The number of failed attempts at establishing a class 3 connection with a Logix controller.
Tag Not Exist Errors	The number of failed tag read/write transactions due to a non-existent destination tag.
Privilege Violations	The number of failed tag read/write transactions due to a privilege violation error. This may be caused by the <i>External Access</i> property of the Logix tag being set to either None or Read Only .
Tag Reads	The number of tag read transactions executed by the PLX51-DL-232.

5.2.3 Tag Status Tab

The *Tag Status* tab provides current values for all tags, along with their trigger settings. The following tag mapping statistics are only relevant when the PLX51-DL-232 is running in either *Reactive Tag* or *Scheduled Tag* mode.

TagID	Device	Tagname	Value	Δy	Time	Min ΔT	Max ΔT
1	MBR01	Reg01	40.000	0	0.0	0.0	1.0
2	MBR01	Reg02	3.000	15	0.0	1.0	1.0
3	MBR01	Reg03	1.000	1	0.0	1.0	1.0
4	MBR01	Reg04	50.000	15	0.0	1.0	1.0
5	MBR01	Reg05	1234...	15	0.0	1.0	1.0
7	MBR01	Reg06	9998....	1000	0.0	1.0	1.0
8	MBR01	Reg07	0.000	100	4294...	1.0	1.0
9	MBR01	Reg09	40.000	1	0.0	1.0	1.0

Figure 5.6 – Tag Status

Table 5.5 – Tag Status

Statistic	Description
TagID	Configured Tag ID for the specific Tag/Register/File.
Device	The configured source device where the tag is extracted.
Tagname	The Tagname configured for the specific tag.
Value	The last read value from the specific tag.
Delta Y	Configured deadband for the tag value.
Time	The time in seconds since the last data was logged.
Min Delta Time	Minimum time in seconds between consecutive data logging.
Max Delta Time	Maximum time in seconds between consecutive data logging.

5.2.4 Recent Records Tab

The *Recent Records* tab provides a list of the last records recorded with their time stamp and value.

Index	Date Time	TagID	Device	Tagname	Value
3141	3/27/2018 6:44:55 AM	3	Logix129	MyRealArr[0]	0
3142	3/27/2018 7:44:55 AM	7	Logix129	MyRealArr[5]	0
3143	3/27/2018 7:44:55 AM	1	Logix129	MyReal1	33.8
3144	3/27/2018 7:44:55 AM	2	Logix129	MyDINT1	8335108
3145	3/27/2018 7:44:55 AM	3	Logix129	MyRealArr[0]	0
3146	3/27/2018 7:44:55 AM	4	Logix129	MyRealArr[1]	0
3147	3/27/2018 7:44:55 AM	5	Logix129	MyRealArr[3]	0
3148	3/27/2018 7:44:55 AM	6	Logix129	MyRealArr[4]	0

Figure 5.7 – Recent Records

Table 5.6 – Recent Records

Statistic	Description
Index	Logged data index.
Date Time	The time stamp when the data was logged.
Tag ID	Configured Tag ID for the specific Tag/Register/File.
Device	The configured source device where the tag is extracted.
Tagname	The Tagname configured for the specific tag.
Value	The last logged value from the specific tag.

5.2.5 Record Management Tab

The *Record Management* tab manages the PLX51-DL-232 records. Records can be downloaded to a (.csv) file format. Options to reset the log indices and erasing the cache are also available.

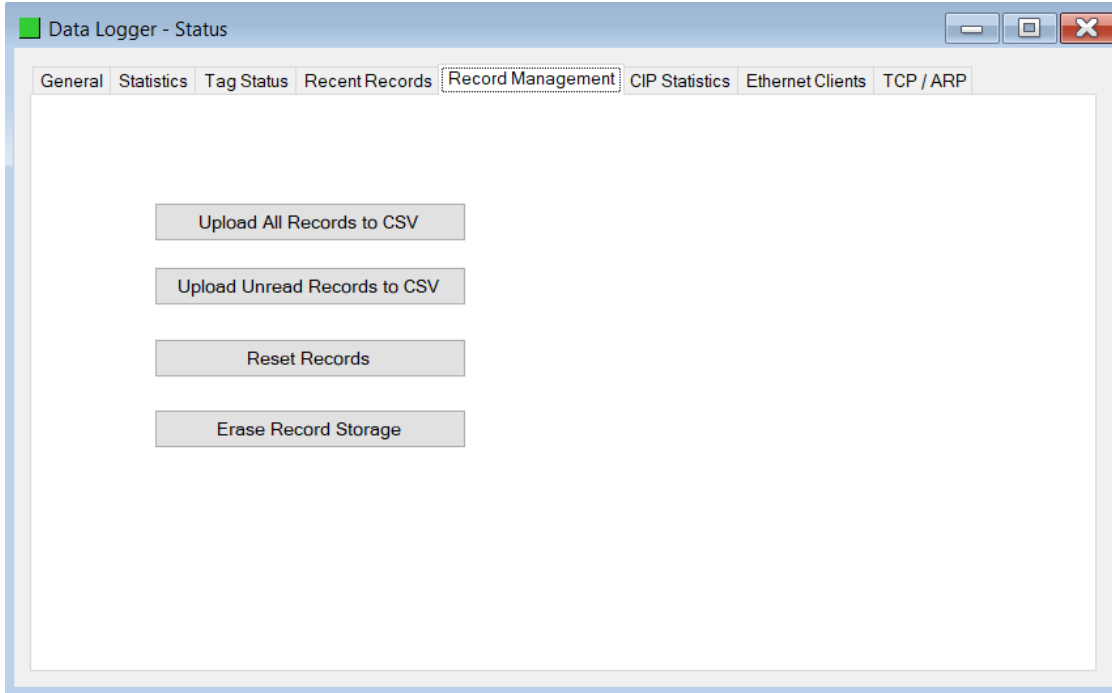

Figure 5.8 – Record Management

Table 5.7 – Record Management

Parameter	Description
Upload All Records to CSV	Upload all records currently in the module.
Upload Unread Records to CSV	Upload unread records currently in the module.
Reset Records	Resets the log indices
Erase Record Storage	Erases the cache of all records

5.2.6 CIP Statistics Tab

The *CIP Statistics* tab provides a set of Common Industrial Protocol (CIP) communication statistics.

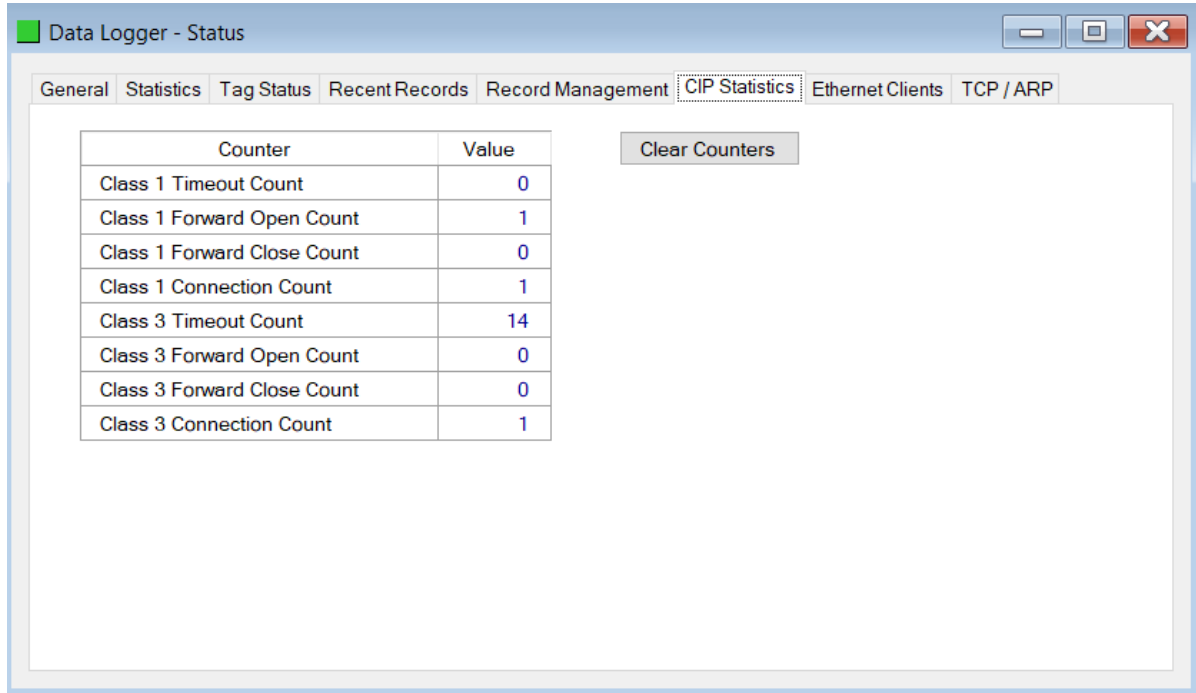

Figure 5.9 – CIP Statistics

Table 5.8 – CIP Statistics

Statistic	Description
Class 1 Timeout Count	Number of times a Class 1 connection has timed out
Class 1 Forward Open Count	Number of Class 1 Connection establish attempts
Class 1 Forward Close Count	Number of Class 1 Connection close attempts
Class 1 Connection Count	Number of Class 1 Connections currently active
Class 3 Timeout Count	Number of times a Class 3 connection has timed out
Class 3 Forward Open Count	Number of Class 3 Connection establish attempts
Class 3 Forward Close Count	Number of Class 3 Connection close attempts
Class 3 Connection Count	Number of Class 3 Connections currently active

5.2.7 Ethernet Clients Tab

The *Ethernet Clients* tab provides a count of EtherNet Client and EtherNet/IP connections.

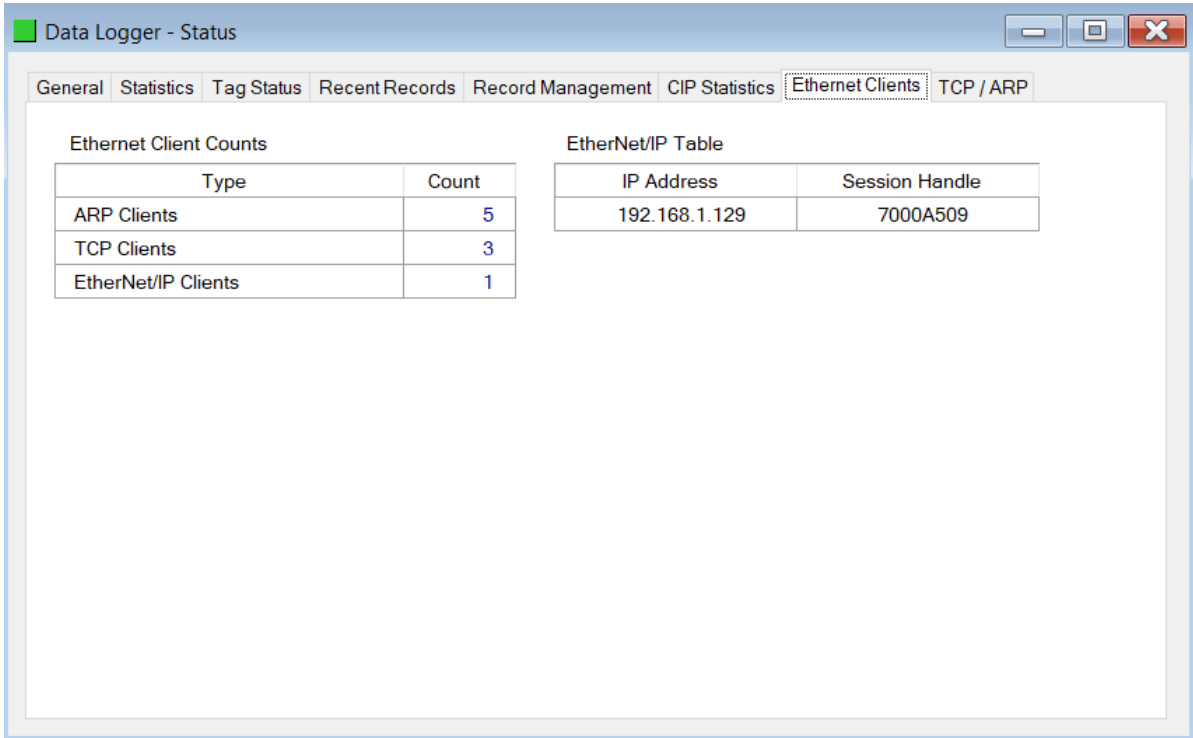

Figure 5.10 – Ethernet Connection Counts

Table 5.9 – CIP Statistics

Statistic	Description
ARP Clients	Number of active clients in the ARP table
TCP Clients	Number of active connections in the TCP client table
EtherNet/IP Clients	Number of active connections in the ENIP client table

Table 5.10 – EtherNet/IP Table

Statistic	Description
IP Address	IP address of the client in the ENIP client table
Session Handle	Session handle in the ENIP client table

5.2.8 TCP / ARP Tab

The *TCP / ARP* tab lists the ARP and TCP/IP information associated with the known MAC addresses in the network. Parameters include the *IP Address*, *Remote Port* number, and *Local Port* number.

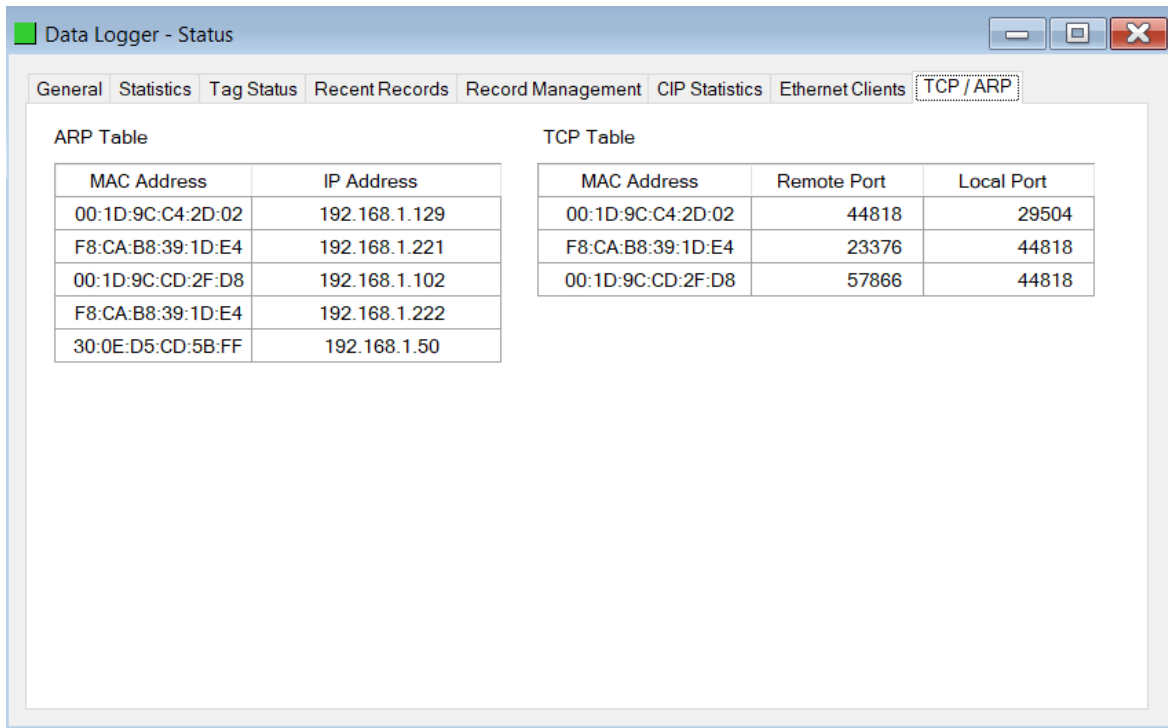

Figure 5.11 – TCP and ARP Table Entries

Table 5.11 – ARP Table

Statistic	Description
MAC Address	MAC address of the client in the ARP Table
IP Address	IP address of the client in the ARP Table

Table 5.12 – TCP Table

Statistic	Description
MAC Address	MAC address of the client in the TCP Table
Remote Port	Remote TCP port of the client in the TCP Table
Local Port	Local TCP port of the client in the TCP Table

5.3 DF1 Packet Capture

The PLX51-DL-232 provides the capability to capture the DF1 traffic for analysis.

- 1 To begin the packet capture of the PLX51-DL-232, double-click on the *DF1 Packet Capture* selection in the Project Explorer tree.

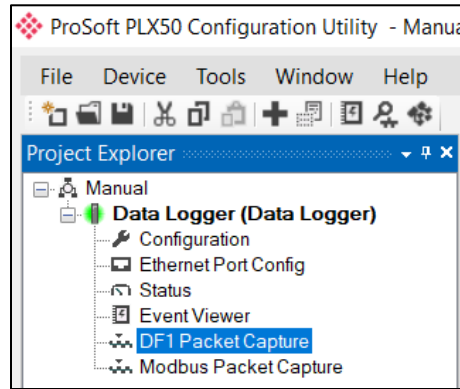

Figure 5.12 - Selecting DF1 Packet Capture

- 2 The *DF1 Packet Capture* window opens and automatically starts capturing all DF1 packets.

Note: The PLX51-DL-232 keeps a circular buffer of the last twenty DF1 packets. Thus, there may be up to 20 packets in the capture that were received / sent before the capture was initiated.

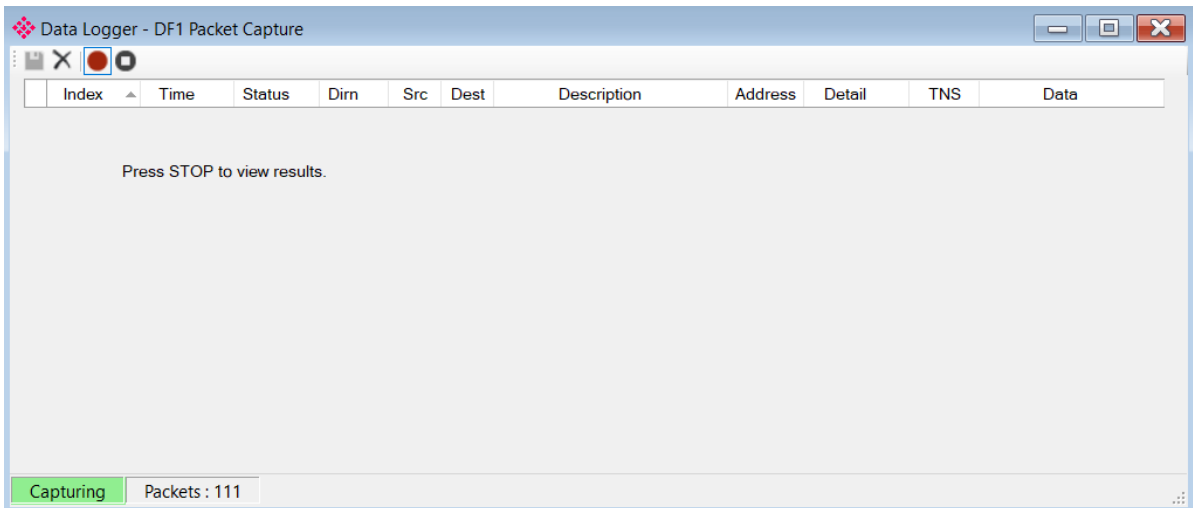

Figure 5.13 - DF1 packet capture

- To display the captured DF1 packets, the capture process must first be stopped by pressing the **STOP** button.

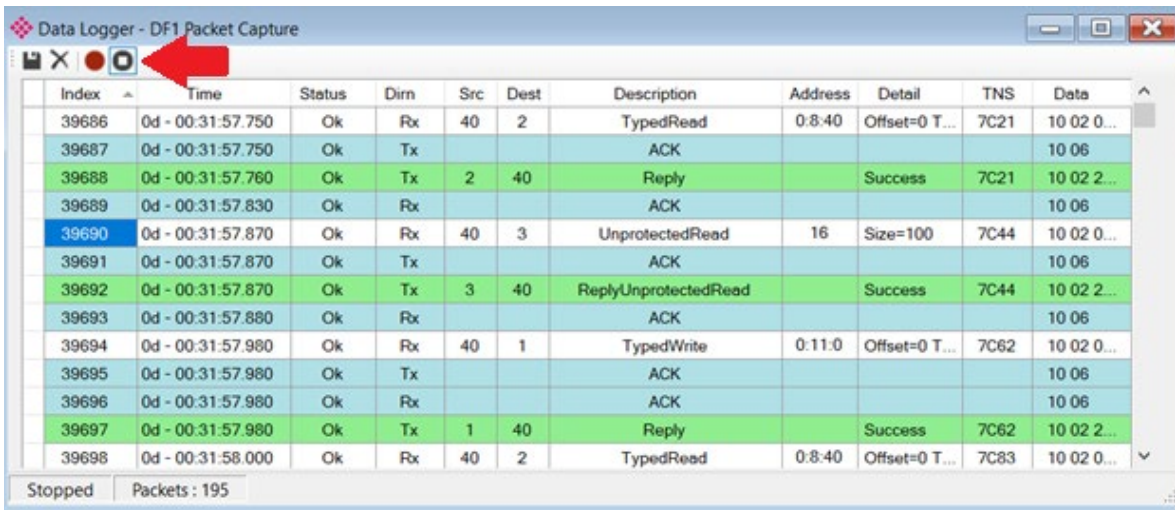

Figure 5.14 - DF1 Packet Capture complete

The captured DF1 packets are listed as follows:

Table 5.13 - DF1 Packet Capture fields

Statistic	Description
Index	The packet index, incremented for each packet sent or received.
Time	The elapsed time since the PLX51-DL-232 was powered up.
Status	The status of the packet. Received packets are checked for valid DF1 constructs and valid checksums.
Dirn	The direction of the packet, either transmitted (Tx) or received (Rx).
Src	DF1 node address of the message source.
Dest	DF1 node address of the message destination.
Description	Brief description of the packet, usually the command.
Address	The string representing a PLC data address, where applicable.
Detail	Additional details associated with command.
TNS	Transaction number. Used to match request and reply messages.
Data	The packet's raw data displayed in space delimited hex.

- The packet capture can be saved to a file for further analysis by selecting the **SAVE** button on the toolbar.

- 5 Previously saved DF1 Packet Capture files can be viewed by selecting the *DF1 Packet Capture Viewer* option in the *Tools* menu.

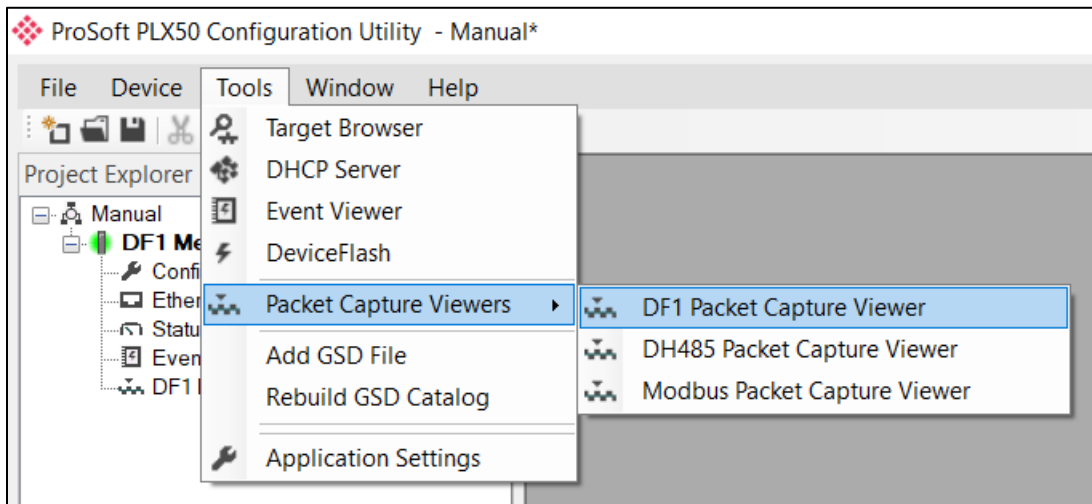

Figure 5.15 - Selecting the DF1 Packet Capture Viewer

5.4 Modbus Packet Capture

The PLX51-DL-232 provides the capability to capture the Modbus traffic for analysis.

- 1 To begin the capture of the PLX51-DL-232, double-click on the *Modbus Packet Capture* selection in the Project Explorer tree.

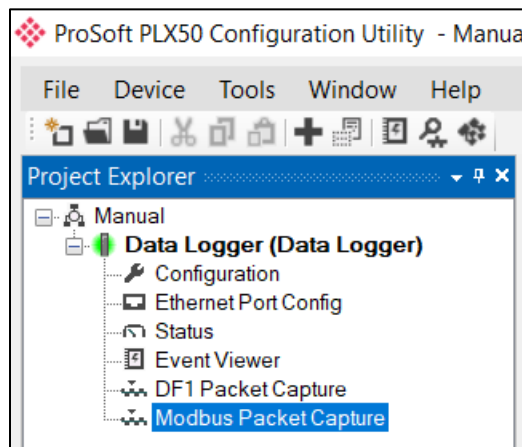

Figure 5.16 - Selecting Modbus Packet Capture

- The *Modbus Packet Capture* window opens and automatically starts capturing all Modbus packets.

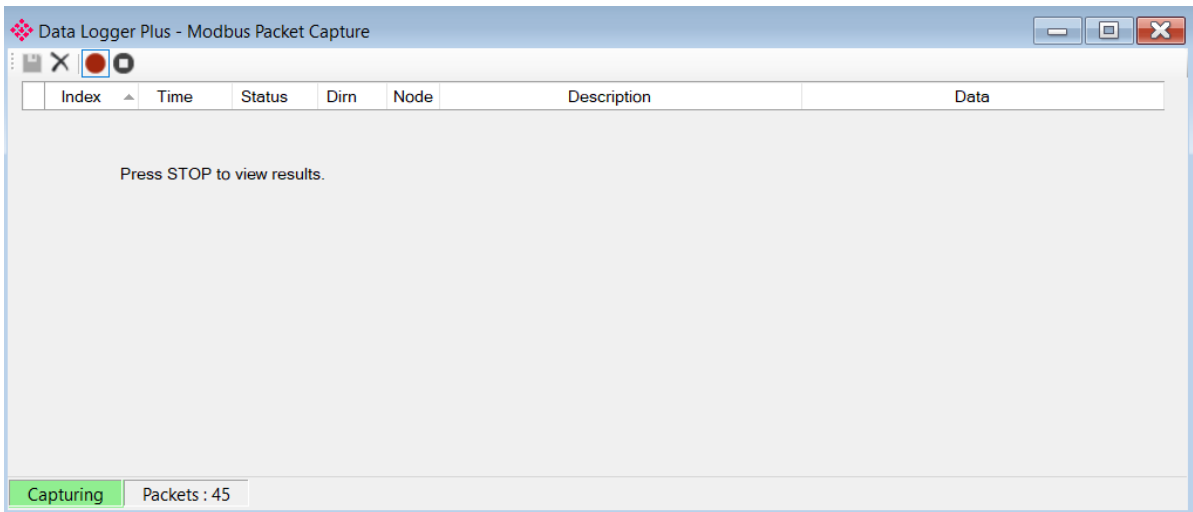

Figure 5.17 – Modbus packet capture

- To display the captured Modbus packets, the capture process must first be stopped by pressing the **STOP** button.

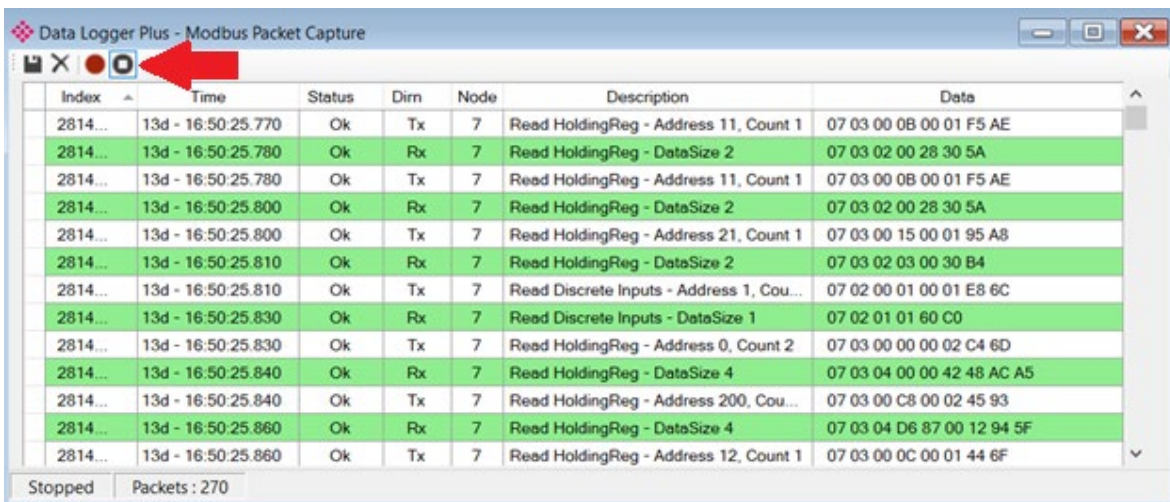

Figure 5.18 – Modbus Packet Capture complete

The captured Modbus packets are tabulated as follows:

Table 5.14 – Modbus Packet Capture fields

Statistic	Description
Index	The packet index, incremented for each packet sent or received.
Time	The elapsed time since the PLX51-DL-232 was powered up.
Status	The status of the packet. Received packets are checked for valid Modbus constructs and valid checksums.
Dirn	The direction of the packet, either transmitted (Tx) or received (Rx).
Node	Modbus node address of the message destination.
Description	A brief description of the packet, showing the function and register range if applicable.
Data	The raw packet data.

- 4 The packet capture can be saved to a file for further analysis by selecting the **SAVE** button on the toolbar.
- 5 Previously saved Modbus Packet Capture files can be viewed by selecting the *Modbus Packet Capture Viewer* option in the *Tools* menu.

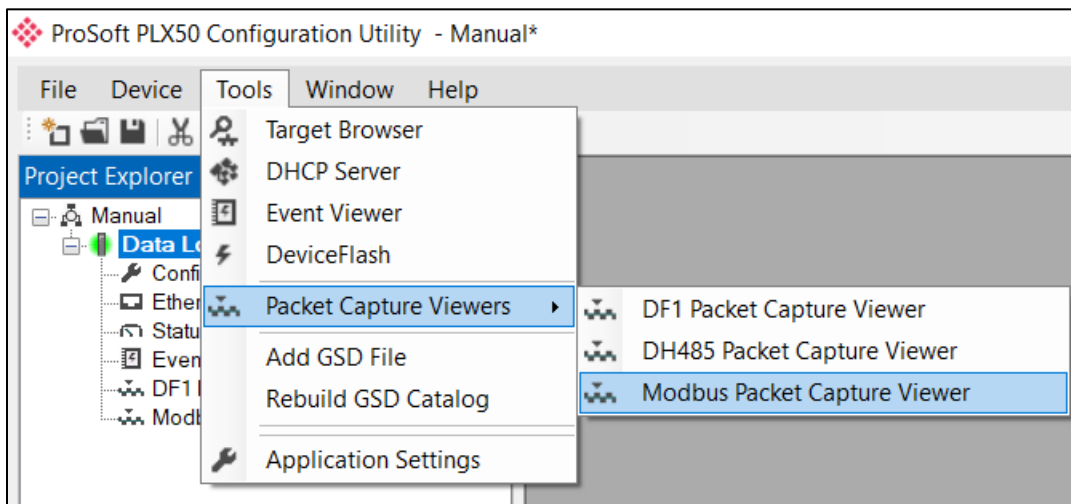

Figure 5.19 - Selecting the Modbus Packet Capture Viewer

5.5 Module Event Log

The PLX51-DL-232 logs various diagnostic records to an internal event log. These logs are stored in non-volatile memory and can be displayed in the PLX50 Configuration Utility or the web server.

To view them in the PLX50 Configuration Utility, select the *Event Viewer* option in the Project Explorer tree.

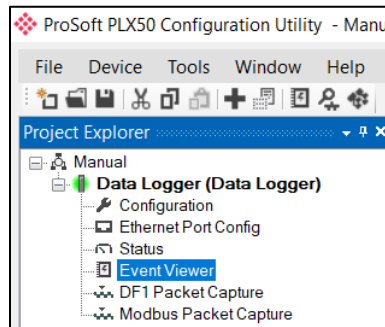

Figure 5.20 - Selecting the PLX51-DL-232 Event Log

- 6 The *Event Log* window opens and automatically reads all the events from the PLX51-DL-232.
- 7 The log entries are listed with the latest record at the top. Custom sorting is achieved by double-clicking on the column headings.

Index	Time	Up Time	Event
76	2017/08/16 15:54:13	0d - 00:23:09	Could not find callback id
75	2017/08/16 15:54:13	0d - 00:23:09	Application Config Valid
74	2017/08/16 15:49:06	0d - 00:18:40	Application Config Valid
73	2017/08/16 15:45:31	0d - 00:14:46	System date and time updated
72	2017/08/16 15:45:27	0d - 00:14:42	Could not find callback id
71	2017/08/16 15:45:27	0d - 00:14:42	Application Config Valid
70	2017/08/16 15:30:16	0d - 00:01:25	Parameters updated
69	2017/08/16 15:30:16	0d - 00:01:24	Parameters updated
68	2017/08/16 15:30:16	0d - 00:01:24	Could not find callback id
67	2017/08/16 15:30:16	0d - 00:01:24	Could not find callback id
66	2017/08/16 15:30:16	0d - 00:01:24	Could not find callback id
65	2017/08/16 15:30:16	0d - 00:01:24	Could not find callback id
64	2017/08/16 15:29:24	0d - 00:00:39	Parameters updated
63	2017/08/16 15:29:24	0d - 00:00:39	Parameters updated
62	2017/08/16 15:28:41	0d - 00:00:02	Ethernet link up
61	2017/08/16 15:28:41	0d - 00:00:02	Application code running
60	2017/08/16 15:28:40	0d - 00:00:00	Application Config Valid
59	2017/08/16 15:28:40	0d - 00:00:00	Application Admin Config Valid

Figure 5.21 – Module Event Log

- 8 The log can also be stored to a file for future analysis by selecting the **SAVE** button in the tool menu. To view previously saved files, use the *Event Log Viewer* option under the *Tools* menu.

5.6 Web Server

The PLX51-DL-232 provides a web server allowing you to view various diagnostics of the PLX51-DL-232 without the PLX50 Configuration Utility or RSLogix 5000. This includes Ethernet parameters, system event log, advanced diagnostics, and application diagnostics (DF1 diagnostics).

Note: The web server is read-only, no parameters or configuration can be altered from the web interface.

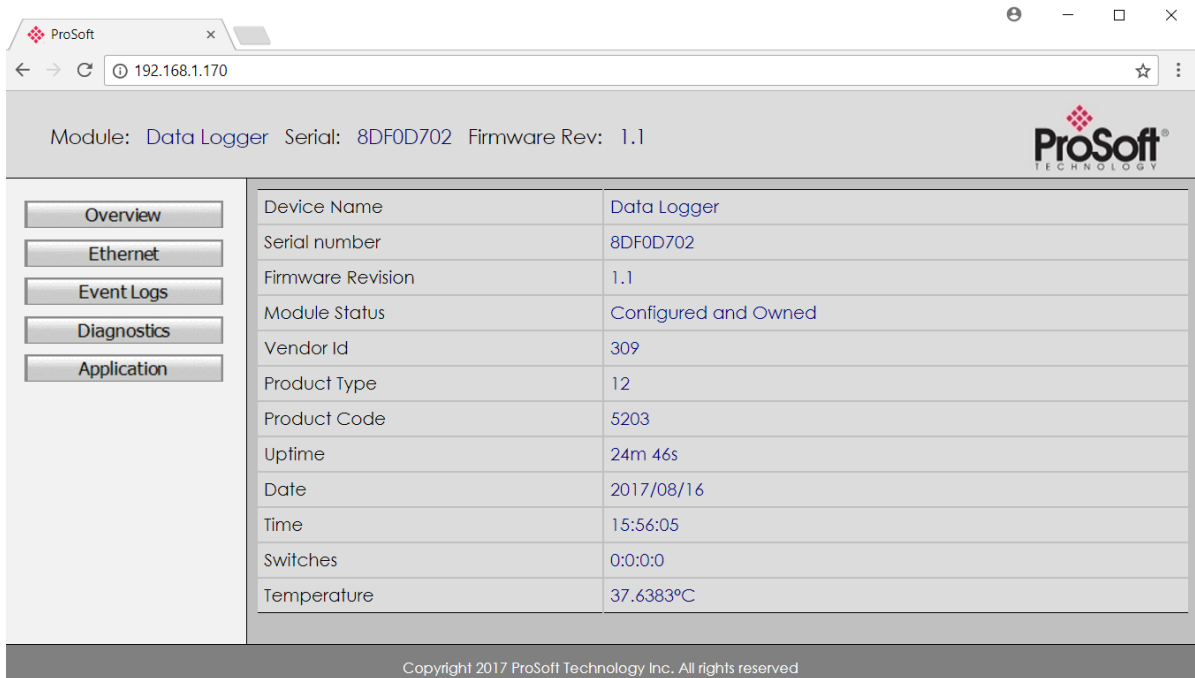

Figure 5.22 - Web interface

6 Technical Specifications

6.1 Dimensions

Below are the PLX51-DL-232 enclosure and DIN rail dimensions. All dimensions are in millimeters.

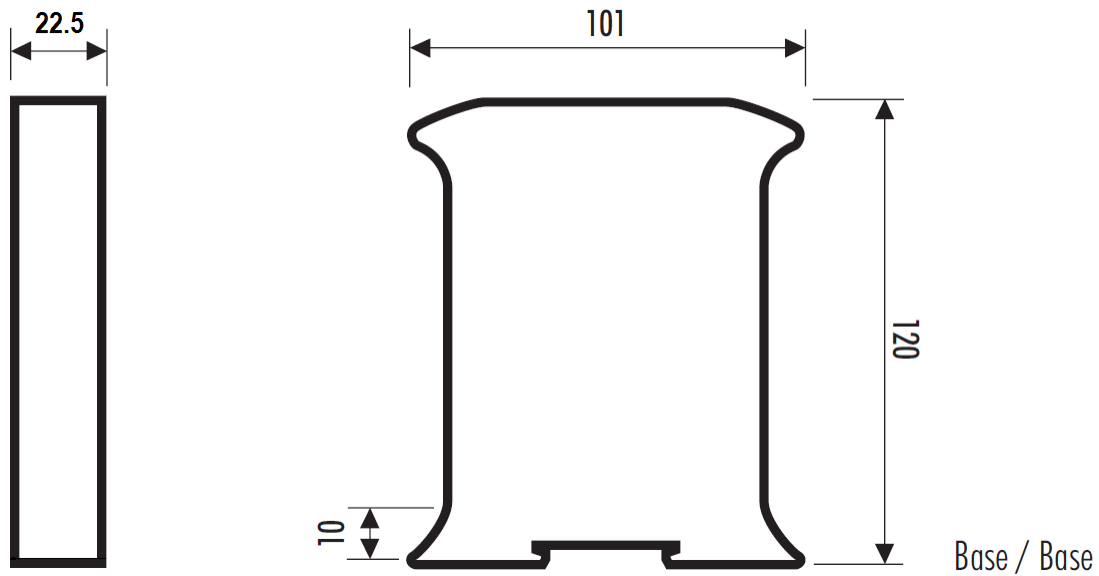

Figure 6.1 - Module Enclosure Dimensions

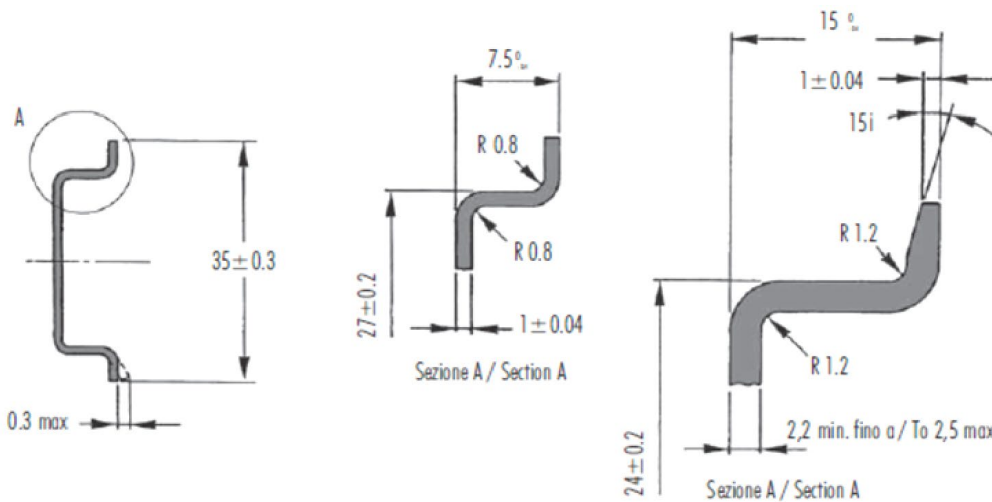

Figure 6.2 - Required DIN dimensions

6.2 Electrical

Table 6.1 - Electrical specification

Specification	Rating
Power requirements	Input: 10 to 28V DC, (70 mA @ 24 VDC)
Power consumption	1.7 W
Connector	3-way terminal
Conductors	24 to 18 AWG
Enclosure rating	IP20, NEMA/UL Open Type
Temperature	-20 to 70 °C
Earth connection	Yes, terminal based
Emissions	IEC61000-6-4
ESD Immunity	EN 61000-4-2
Radiated RF Immunity	IEC 61000-4-3
EFT/B Immunity	EFT: IEC 61000-4-4
Surge Immunity	Surge: IEC 61000-4-5
Conducted RF Immunity	IEC 61000-4-6

6.3 Ethernet

Table 6.2 - Ethernet specification

Specification	Rating
Connector	RJ45
Conductors	CAT5 STP/UTP
ARP connections	Max 20
TCP connections	Max 20
CIP connections	Max 10
Communication rate	10/100 Mbps
Duplex mode	Full/Half
Auto-MDIX support	Yes

6.4 Data Cache

Table 6.3 – Data Cache specification

Specification	Rating
Max Record Count	16,777,216
Maximum tag count	200
Log criteria supported	Delta change Heart beat Tag Triggers
Minimum Log Interval	50 ms
Data Types Supported	BOOL, SINT, INT, DINT, or REAL
Cached Records Non-Volatile	Yes
Log triggers supported	Yes
Data Sources	Logix Tags DF1 Files Modbus (RTU and TCP/IP) registers

6.5 Serial Port

Table 6.4 – Serial Port specification

Specification	Rating
Connector	4-way terminal
Conductor	24 to 18 AWG
Isolation voltage	2.5 kV
BAUD	1200, 2400, 4800, 9600, 19200, 38400, 57600, 115200
Parity	None, Even, Odd

6.6 DF1

Table 6.5 - DF1 specification

Specification	Rating
Duplex	Full/Half
Error detection	CRC, BCC
Embedded response	Auto, On

6.7 Modbus

Table 6.6 - Modbus specification

Specification	Rating
Supported Ports	Modbus RTU Modbus TCP/IP
Functions Supported	Read Coils (Function Code 1) Read Discrete Inputs (Function Code 2) Read Holding Register (Function Code 3) Read Input Register (Function Code 4)

7 Support, Service & Warranty

7.1 Contacting Technical Support

ProSoft Technology, Inc. is committed to providing the most efficient and effective support possible. Before calling, please gather the following information to assist in expediting this process:

- 1 Product Version Number
- 2 System architecture
- 3 Network details

If the issue is hardware related, we will also need information regarding:

- 1 Module configuration and associated ladder files, if any
- 2 Module operation and any unusual behavior
- 3 Configuration/Debug status information
- 4 LED patterns
- 5 Details about the interfaced serial, Ethernet or Fieldbus devices

Note: For technical support calls within the United States, ProSoft's 24/7 after-hours phone support is available for urgent plant-down issues.

<p>North America (Corporate Location) Phone: +1.661.716.5100 info@prosoft-technology.com Languages spoken: English, Spanish REGIONAL TECH SUPPORT support@prosoft-technology.com</p>	<p>Europe / Middle East / Africa Regional Office Phone: +33.(0)5.34.36.87.20 france@prosoft-technology.com Languages spoken: French, English REGIONAL TECH SUPPORT support.emea@prosoft-technology.com</p>
<p>Latin America Regional Office Phone: +52.222.264.1814 latinam@prosoft-technology.com Languages spoken: Spanish, English REGIONAL TECH SUPPORT support.la@prosoft-technology.com</p>	<p>Asia Pacific Regional Office Phone: +60.3.2247.1898 asiapc@prosoft-technology.com Languages spoken: Bahasa, Chinese, English, Japanese, Korean REGIONAL TECH SUPPORT support.ap@prosoft-technology.com</p>

For additional ProSoft Technology contacts in your area, please visit:

<https://www.prosoft-technology.com/About-Us/Contact-Us>.

7.2 Warranty Information

For complete details regarding ProSoft Technology's TERMS & CONDITIONS OF SALE, WARRANTY, SUPPORT, SERVICE AND RETURN MATERIAL AUTHORIZATION INSTRUCTIONS, please see the documents at:

www.prosoft-technology/legal