

# Remote Connectivity Solutions

Remote connectivity to industrial assets is a game-changer for end users, machine builders, and system integrators, and can bring several benefits:

- Reduce machine or plant downtime
- Reduce support time and costs
- Access to improved data for predictive maintenance modeling
- Reduce the mean time to repair (MTTR)
- Provide connectivity through to other business systems

Solving these problems will lead to improved Overall Equipment Effectiveness (OEE), and increased productivity and efficiency resulting in increased profitability. Likewise, remote connectivity to industrial assets is the first step towards any Industrial Internet of Things (IIoT) implementation. IIoT helps you optimize resources, streamline information flow between business units, enabling informed real-time decisions. Other benefits include increased product quality and process innovation.



## On-Demand Secure Remote Connectivity: Anytime, Anywhere, Anyhow

Remote connectivity to industrial assets is one of 2 types:

- An on-demand connection, typically used for a specific purpose like diagnostics, change settings, or a quick status check
- An always-on connection, typically used to connect remote assets to form a network like a SCADA or telemetry network for continuous machine monitoring

Our remote connectivity solution supports both of these connection types. The on-demand connection is called Secure Remote Access (SRA) while the always-on connection is called a Persistent Data Network (PDN). Our solution pairs wired or wireless connectivity gateways with Belden Horizon™ (formerly known as ProSoft Connect®), an IT-secure and user-friendly cloud-native platform. Belden Horizon allows users to connect to and manage their remote connectivity from any platform or device, including mobile devices, using our native apps on Google Play or the App Store.

ProSoft's remote connectivity solutions use a defense-in-depth approach to ensure an unprecedented level of safety and security for your application. Some of these measures include digitally signed firmware, single-use passwords, single sign-on (SSO), Virtual Lockout-Tagout (vLOTO™), 256-bit AES encryption, and token-based two-factor authentication (2FA).

Lastly, the Data Logger Plus assists with time-stamped recording of critical data for extended periods so you won't strain your network or lose any valuable changes, providing integrity and accuracy to your predictive maintenance efforts.

### TERMS TO KNOW

#### REMOTE CONNECTIVITY

Process of connecting to a remote asset for a specific purpose (like diagnosing the asset) or to enable communications between remote assets.

#### OPENVPN

Open-source software that allows customers to create a secure point-to-point private network; works by establishing a tunnel between the VPN client and VPN server.

#### IPSEC

#### (INTERNET PROTOCOL SECURITY)

Secure protocol used across an IP network between 2 or more devices; supports authentication, integrity, and confidentiality of the data by encrypting, decrypting, and authenticating packets.

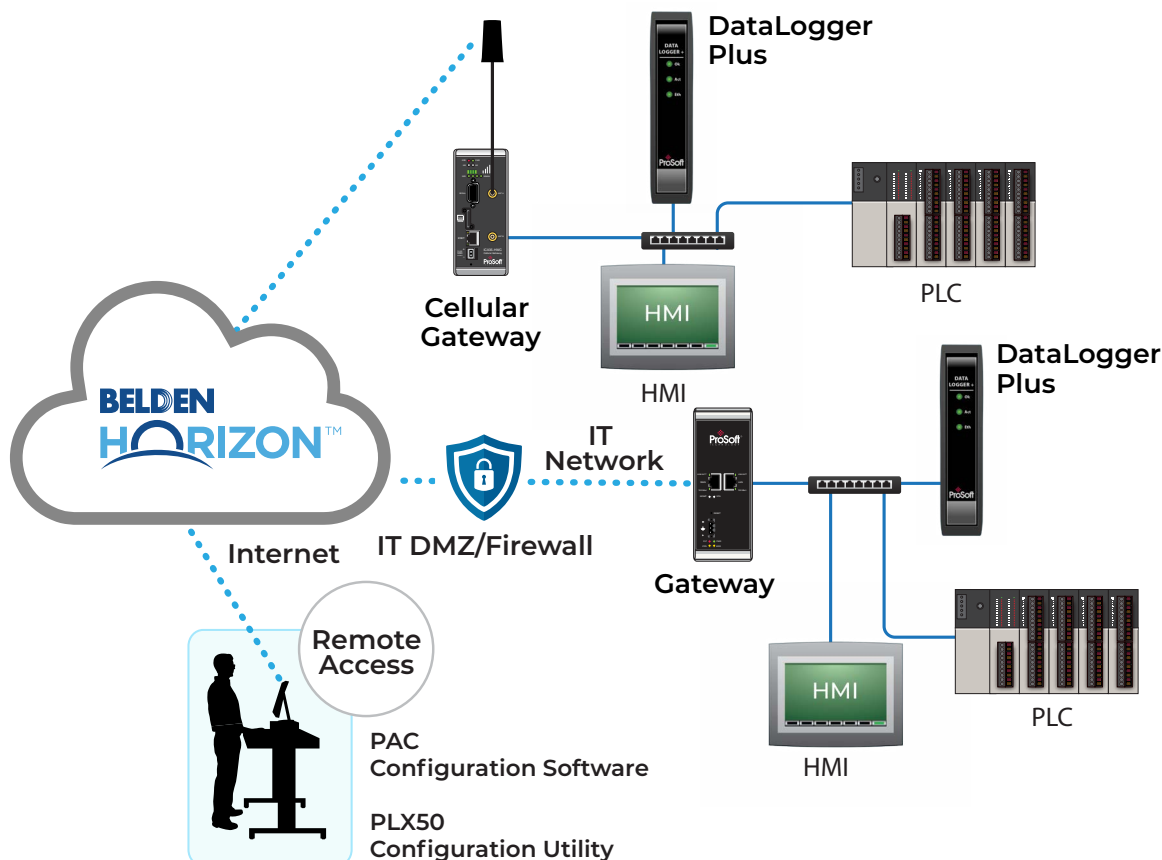

## PDN Always-on Persistent Data Network – Simple, Secure, and Managed

Persistent Data Network, or PDN, is an always-on simple, secure, and managed cloud-native infrastructure network to connect your remote assets. Think of PDN as an Ethernet switch in the cloud – devices connected to this switch securely communicate with each other.

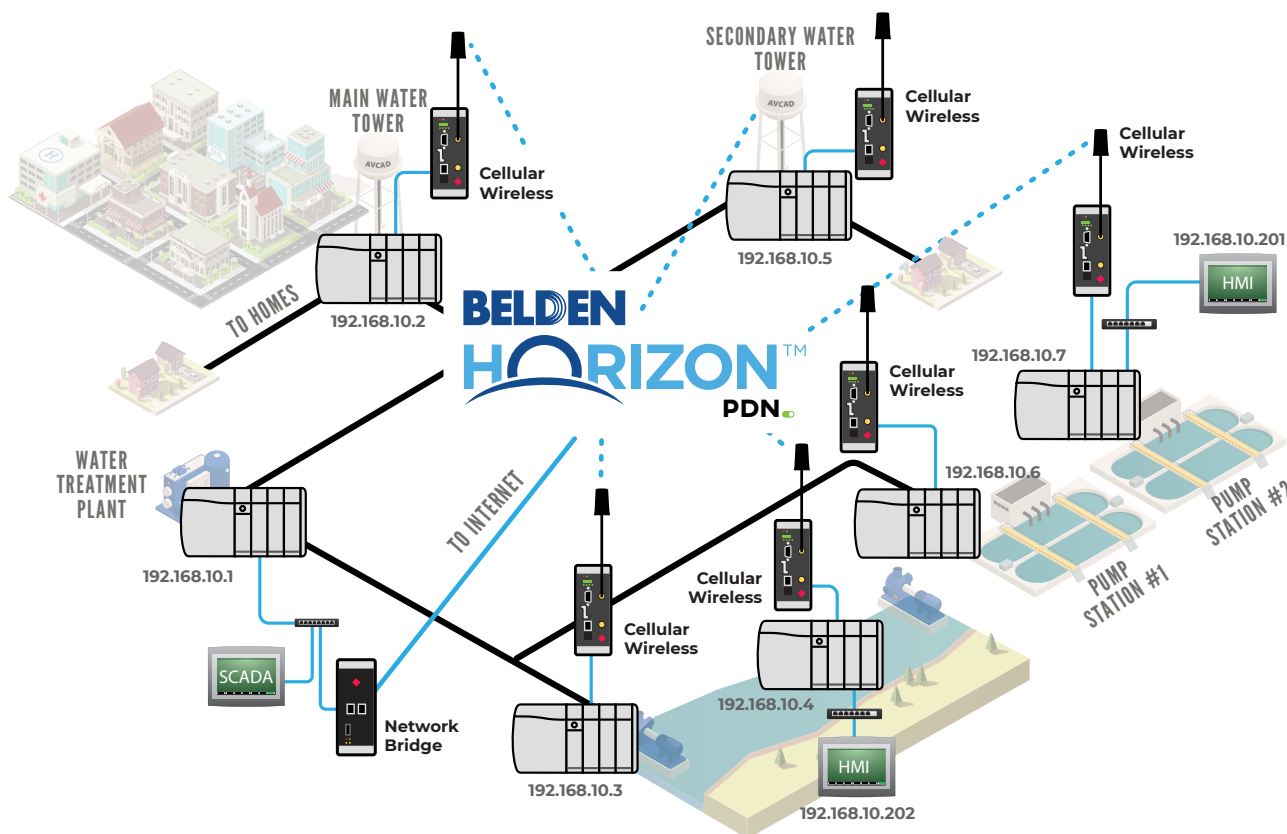

PDN eliminates the need for in-house VPN expertise, additional IT equipment, and 24/7 IT monitoring of an OT communications network! PDN is a secure and managed subscription service, offering the following benefits to the customer:

### Simple

- PDN is the easiest way to create a remote cloud-based infrastructure network for communications between remote assets.
- Supports a Layer 2 network for easy management of remote assets.
- The increased bandwidth and speed will allow you to bring back more data across the globe, more frequently.

### Secure

- Multiple layers (defense-in-depth) – includes, but is not limited to, one-time-use passwords, SSO, token-based 2FA, vLOTO, 256-bit AES encryption
- Anytime, Anywhere, Anyhow remote access to assets

### Managed

- PDN is a Belden Horizon-managed network, layered with redundancy and security, that allows the user to focus on their most important task - delivering their service, correctly and efficiently.
- PDN is inexpensive to get started when compared to a traditional radio-based RF network.

## How Belden Horizon Works – and Why You Can Trust It



**Keeping your information safe is important to you, and paramount to us as well!**

That's why Belden Horizon uses several measures to maximize the security of the system, put your IT department at ease, and make sure the IT-OT integration is simplified. Because the service is OT-friendly and IT-secure, you can spend more time monitoring your equipment and less time maintaining your remote access.



### How Secure is the Platform?

In a word? Very.

- **Advanced two-factor authentication:**  
Belden Horizon's authentication methods are aligned with RFC 6238 and RFC 4426. We do not use SMS as the second form of authentication because NIST has warned about the vulnerability of this method. Instead, we've opted to confirm Power Users' login via a soft token-based approach, and Standard Users' login via email. This level of authentication also helps minimize the risks behind password sharing within or outside of your organization. You can even replace our authentication mechanism with your own Identity Provider for even more options.
- **Tunnels** are dynamically created with one-time uniquely generated passwords. Your machine data is protected with 256-bit AES encryption in these tunnels.
- Uses HTTPS for all communications
- Third-party security and penetration experts regularly and thoroughly test Belden Horizon for vulnerabilities, and we quickly fix and update software if any are found
- By using your PC's operating system **VPN**, the platform lets you avoid user-installed software, an entry point for some hackers
- **Layer 2 Tunneling Protocol (L2TP)/IPSec** and Secure Socket Tunneling Protocol (SSTP) support increases VPN security for all popular **clients** including Windows, and iOS products. and easily allows you to see your remote devices rather than try to remember them
- Simple and secure one-time gateway activation for each new gateway
- IP Allow List: Customers can list specific device IP addresses that can be accessed remotely
- Virtual Lockout-Tagout (vLOTO™): Customers must obtain permission prior to establishing a secure remote connection
- User-configurable password policy
- Active Directory support via Single Sign-On
- Role-based user and device access



### Belden Horizon Lite App

What if you're sitting on a beach when a customer call comes in with a critical issue? You don't have to give up that view or worry you'll upset your customer - you can access Belden Horizon via an app that is available to download at the App Store!



## And we add a layer of safety that no one else does!

Virtual Lockout-Tagout, or vLOTO, allows for traceable near-instant automated and dynamic tunnel authorization from multiple designated people for a specific duration, avoiding that late-night call to get maintenance access. Being able to control remote connectivity ensures the safety of your equipment during critical tasks – vLOTO can help protect against inadvertent harm caused by someone else connecting to the gateway.

Only authorized people can approve or deny a request to access an ICX35-HWC or PLX35-NB2 gateway. A detailed, secure audit trail notes who grants permission, in addition to tracking tunneling and configuration.

If you're a machine builder or system integrator handling multiple clients, you'll simply and securely separate projects, ensuring an organized workflow. You can enhance the security of your application with Virtual Lockout-Tagout, which requires you to obtain permission before connecting.



Engineer Requests Access



Approver Receives Auto Email



Approver Clicks Approve



Engineer Initiates VPN Tunnel



Engineer Begins Troubleshooting Maintenance

### IP Allow/Deny List

- Easily connect your PC or mobile device act as if it were connected directly to a local switch on the remote network with EasyBridge™ technology. Your PLC vendor's software tools – such as Studio 5000, Unity, TIA Portal, and others – can be used without having to deal with routing.
- Browse your connected devices rather than try to remember a bunch of IP addresses.

### Single Sign-On

Single Sign-On (SSO) means that users are able to access multiple applications with one set of credentials, reducing password weariness. For IT, this means that they are able to manage user access. SSO improves security, IT productivity, and the usability of business resources.

## TERMS TO KNOW

### 2FA (TWO-FACTOR AUTHENTICATION)

Additional layer of security to protect an account; apart from the standard user-name and password, if 2FA is enabled, users will need to enter a one-time-use PIN to gain access to the account.

### SERVER

Device that manages resources, including access to clients.

### VPN (VIRTUAL PRIVATE NETWORK)

Software service that enables you to create a private and encrypted network enabling data transfer between the devices on the network.

### TUNNEL

Encrypted link between client and server.

### CLIENT

Device that is capable of obtaining information from a server.

# Managing Your Devices, Projects, and Clients

## Centralized, Customized Management

With Belden Horizon, you can easily customize your workspace. Your company will be the main Organization in Belden Horizon, with options that help you separate customer operations based on the user plan you choose:

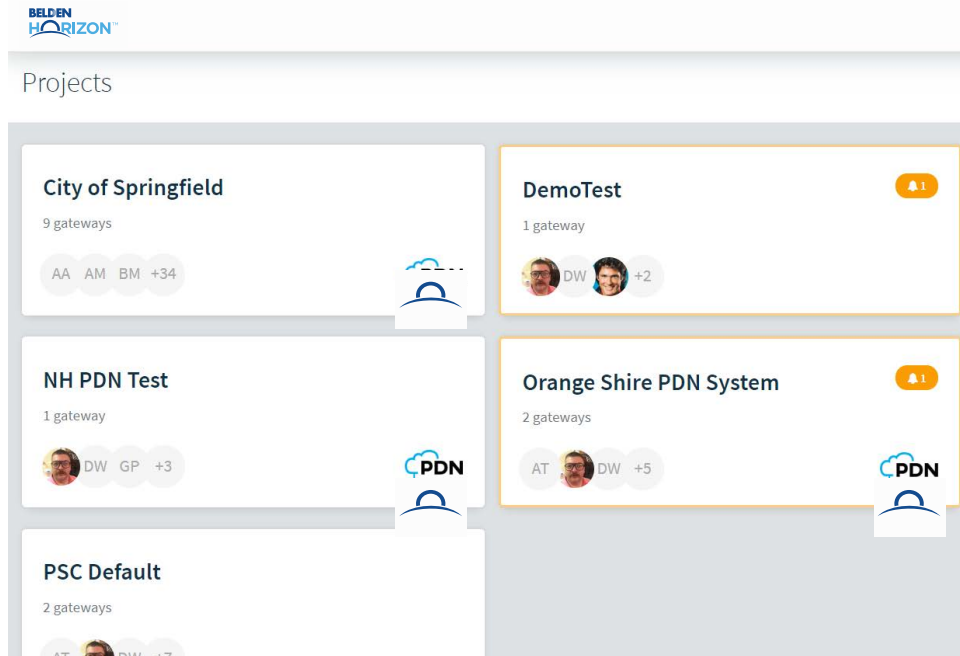

- Multiple Projects allow you to organize your dashboard by client – and you control who joins which projects
- Concurrent connections – including to the same gateway in some plans – allow for flexibility when more than one person needs to have access to the same machine network

• You can group gateways and employees together

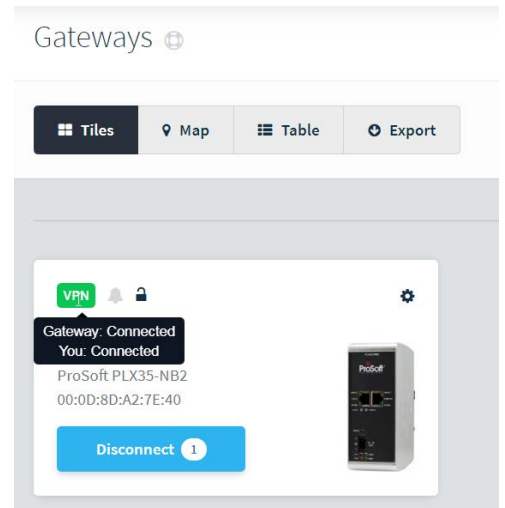
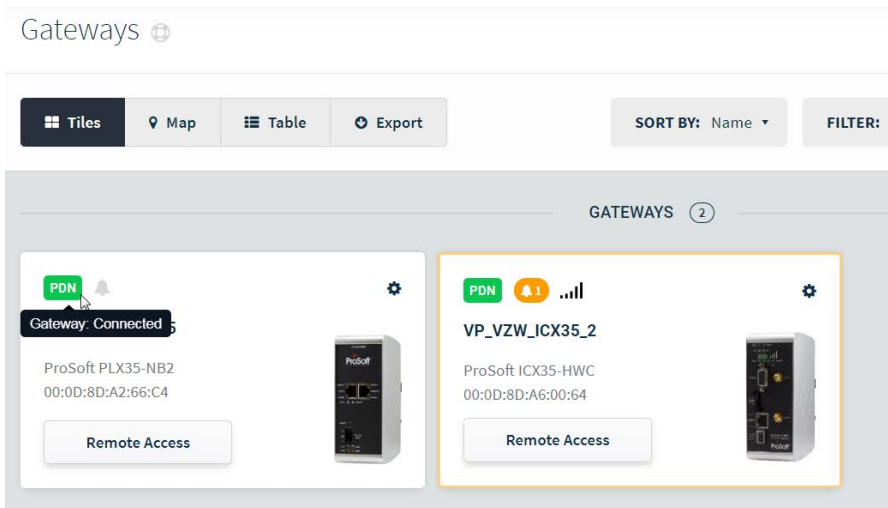

• Increase security by setting permissions for team members in each group

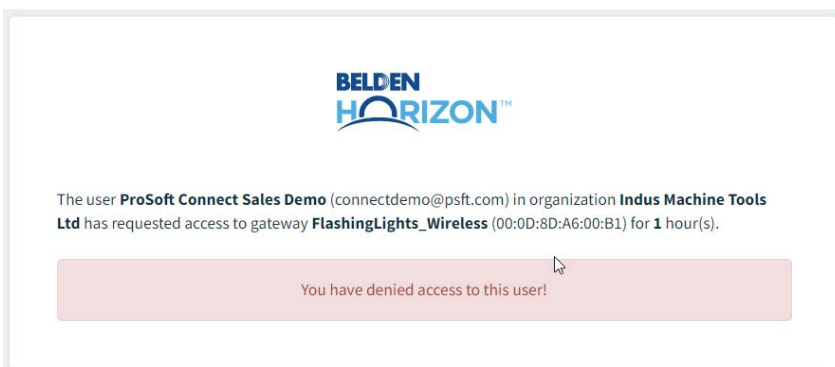

The screenshot displays the Belden Horizon activity feed. At the top, there are navigation links for 'VPN', '0 Open Tunnels', '15 Alerts', 'Activity', and 'Projects'. Below this, a search bar and a 'Filter Activity' button are visible. The main content area shows a list of activity entries for a tunnel named 'Flashing Lights SRA'. The entries include:

- Tunnel has been opened for region US West (Wednesday @ 1:32:21 PM)
- User kblodorn@psft.com logged in from 108.66.200.168 (Wednesday @ 1:26:08 PM)
- Tunnel has been closed for user cmaxwell@psft.com due to VPN client disconnection (Wednesday @ 11:32:04 AM)
- Tunnel has been opened for region US West (Wednesday @ 11:30:55 AM)
- Tunnel has been closed for user cmaxwell@psft.com due to VPN client disconnection (Wednesday @ 11:30:51 AM)
- Tunnel has been opened for region US West (Wednesday @ 11:29:05 AM)
- vLOTO Dynamic Authorization Settings updated (Wednesday @ 11:30:50 AM)

- If you're a user who needs to support multiple customers/sites, you can securely switch between them using one login account
- Need to keep track of who's doing what within the platform? Your audit trail activity feed can be exported to satisfy IT security requirements

## Power User Plans = Advanced Security and Flexibility

With Belden Horizon's Power User Plans, you can customize your platform based on your organization's needs. Power User Plans include increased EasyBridge data, concurrent connections to same or different gateways, multiple projects for machine builders and system integrators supporting several clients, Single Sign-On, and Virtual Lockout-Tagout. Call your ProSoft representative or distributor to request pricing information.

## Business-boosting benefits for OEMs and system integrators without compromising security or backdooring a solution that IT can't help secure.

- Group customer deployments into projects and invite certain employees and contractors to applicable projects
- Offer remote troubleshooting as an additional revenue stream
- Monitor and troubleshoot from a central location to reduce travel support budgets (and all that fun time spent on planes)
- Security-conscious end users want remote connectivity to their machines. Virtual Lockout-Tagout (vLOTO) puts the control and data protection in their hands while making it easy for system integrators and machine builders to request access
- Receive advanced notification of potential issues with leased machines

LEARN MORE ABOUT SECURITY CONSIDERATIONS FOR EACH OF YOUR FACILITY'S ZONES:

# Secure Remote Access Solutions to Fit Your Application

Belden Horizon works with our suite of remote access solutions to provide scalable, flexible options for any application.



## Industrial Cellular Gateway

Need to monitor and troubleshoot equipment in a hard-to-reach spot? This cellular solution:

- Supports 4G LTE, increasing longevity for your application and ensuring clear communications; and is fully backward compatible with 3G where it exists
- Your EtherNet/IP™ & Modbus® TCP/IP controllers can transmit and receive SMS text messages through the gateway via Add-On Instructions
- Global carrier support including Verizon, AT&T, and many LTE networks around the world
- Secure remote connectivity via Belden Horizon
- Highly secure: Supports OpenVPN, IPsec/L2TP with AES-256 bit encryption
- Supports Layer 2 connections, making it easier to remotely connect



## Wired Network Bridge

The Network Bridge is ideal for applications where a wired connection is feasible for remote access.

- Can be enabled/disabled via an EtherNet/IP message from an HMI or PLC
- 2 isolated Ethernet ports separate your IT and OT networks
- Remote access via Belden Horizon
- Support for SD card (up to 32GB)
- File relay - transfer files across segmented networks via SFTP

## Data Loggers



Need to collect data from remote equipment? The Data Loggers do just that without requiring a network infrastructure – ideal for applications that don't have a constant connection. This solution:

- Allows you to store, review, and graph information on your equipment's historical performance, providing insight before you head out to the field to troubleshoot
- Store over 16 million time-stamped records
- OEMs can review machine operational data to determine if a warranty claim is valid
- Can help you improve Overall Equipment Effectiveness (OEE) in future designs via the analysis of historical data

## TERMS TO KNOW

### AES 256-BIT ENCRYPTION (ADVANCED ENCRYPTION STANDARD)

Established by NIST (National Institute of Standards and Technology); 256-bit refers to length of encryption key used to encrypt the message. If someone wants to break the encryption, they have to figure out the right combination out of 256 possible combinations!

### L2TP (LAYER 2 TUNNELING PROTOCOL)

Enables the operation of the VPN over the internet; L2TP by itself is not secure.

### LAYER 2 CONNECTION

Second layer of the 7-layer OSI model for computer networking; a Layer 2 network is a flat structure and all devices must be on the same subnet.

### SFTP

Secure File Transfer Protocol

### OSI

Open Systems Interconnection

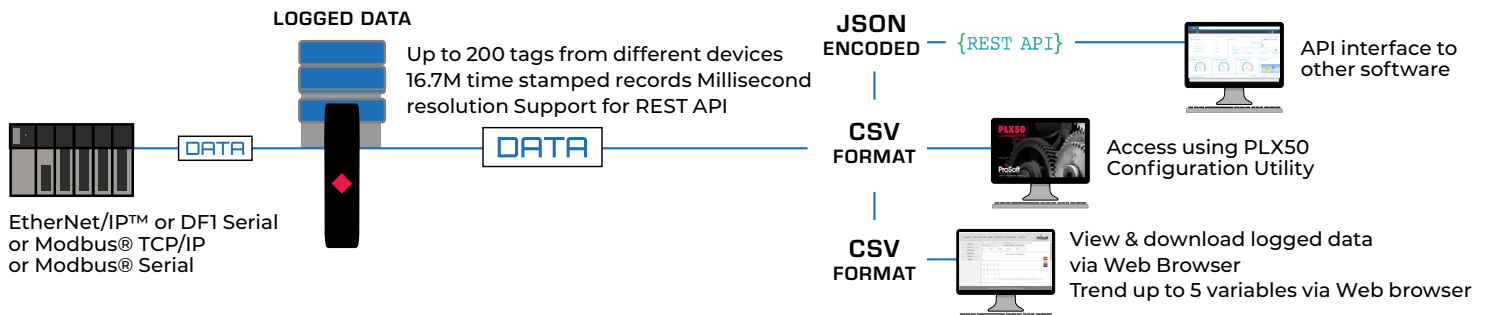

FOR MORE INFORMATION ON THESE REMOTE ACCESS SOLUTIONS:

Data Logger Plus: [psft.com/DC6](http://psft.com/DC6)



Our Remote Connectivity tunnel servers are located in strategic locations globally to provide low-latency tunnels.



### But Won't I Need to Update It?

Nope. That's our job. There are a couple of reasons behind that:

1. Some services are software-based, requiring a patch on your computer every time there's an update. This is one avenue that hackers tend to exploit. Belden Horizon lets you avoid that troublesome user-installed software – we update the program automatically on our side. All you need to access Belden Horizon is a web browser.
2. When we say we're trying to make your remote connectivity painless, we mean it – part of streamlining your process involves not having to waste your IT department's time on troubleshooting an in-house update. Leave the maintenance up to us, and use the platform's chat feature to ask us any questions for prompt service. When you need to partner with IT to align secure remote connectivity, we have you and your favorite IT security group covered.
3. Being designed from the ground up as a cloud-native **distributed microservices architecture** ensures updates can be rolled across our solution with little or no impact.

# Remote Connectivity Solutions

## Real-World Examples

### OIL AND GAS COMPANY NOW REMOTELY MONITORING OPERATION

“Belden Horizon allows my team to remotely access our systems, eliminating significant drive time while improving system operation.”

Learn more: [www.psft.com/C18](http://www.psft.com/C18)



### MONITORING A CITY'S REMOTE LIFT STATIONS

A West Coast city's wastewater division had to make sure its five remote lift stations were working correctly. With the addition of six cellular remote connectivity solutions, they're able to monitor their equipment from a computer, thanks to Belden Horizon, and have reduced transportation costs. Learn more: [www.psft.com/C19](http://www.psft.com/C19)



### KEEPING TRACK OF A COMPACTOR'S STATUS

A major retailer was in need of a solution for its compactor, which crushed boxes within its facilities. The device would need to communicate with the equipment's ControlLogix® and send a notification when the machine was getting too full. The company found its solution in the Industrial Cellular Gateway, which they monitor via Belden Horizon. They've reported saving travel time and expenses for troubleshooting that previously would have required a site visit.



### MACHINE BUILDER REDUCES SERVICE COSTS – AND CUSTOMERS ENJOY DECREASED DOWNTIME

A machine builder that makes highly customized ultrasonic cleaning machines for the global medical industry uses Belden Horizon with ProSoft's Ethernet-based gateway to provide commissioning and maintenance services to their customers. The Belden Horizon solution has helped this machine builder significantly reduce their overall service costs – which has made them very competitive. Their customers are happy with reduced production downtime and prompt remote support.



### WASTEWATER MONITORING VIA ALWAYS-ON MANAGED NETWORK

A New England municipal utility needed to monitor a range of water and wastewater equipment – and their number of sites is only growing. They switched from data radios to cellular gateways and an always-on managed network – and realized several benefits. Learn more: [www.psft.com/DC4](http://www.psft.com/DC4)



## Part Numbers



Data Logger  
PLX51-DL-232 (Basic)



Data Logger +  
PLX51-DLplus-232 (Advanced)



Network Bridge  
PLX35-NB2



Industrial Cellular Gateway  
ICX35-HWC

## Belden Horizon Subscriptions

All subscriptions include advanced features like:

- Token-based two-factor authentication
- Single Sign-On (SSO)
- User-configurable password policies
- Virtual Lockout-Tagout (vLOTO)
- Role-based user and device access
- Concurrent connections to same and different gateways

Secure Remote Access:

- Medium Power User Plan: PSC-PUP-MED-12/24. Includes 3GB of VPN data per gateway per month.
- Large Power User Plan: PSC-PUP-LRG-12/24. Includes 6GB of VPN data per gateway per month.

Persistent Data Network:

- 12-month subscription per site: PSC-PDN-SITE-1Y. Includes 3GB of VPN data per month.
- 24-month subscription per site: PSC-PDN-SITE-2Y. Includes 3GB of VPN data per month.
- 36-month subscription per site: PSC-PDN-SITE-3Y. Includes 3GB of VPN data per month.

## Asia Pacific

### Regional Office

Phone: +603.2242.2020  
asiapc@prosoft-technology.com  
*Languages: Bahasa, Chinese, English, Japanese, Korean*

### Regional Tech Support

support.ap@prosoft-technology.com

### North Asia (China, Hong Kong)

Phone: +86.21.5187.7337  
china@prosoft-technology.com  
*Languages: Chinese, English*

### Southwest Asia

**(India, Pakistan, Sri Lanka, Bangladesh, Mongolia)**

Phone: +91.99.1008.6221  
india@prosoft-technology.com  
*Languages: English, Hindi*

### Australasia

**(Australia, N. Zealand)**

Phone: +61.491.095.248  
pacific@prosoft-technology.com  
*Language: English*

### Southeast Asia

**(Singapore, Indonesia, Philippines, Thailand, Vietnam, Malaysia, Myanmar, Cambodia, Laos, Vietnam)**

Phone: +60.12.275.3307  
seasia@prosoft-technology.com  
*Languages: English, Bahasa, Malay*

### Northeast & Southeast Asia (Japan, Taiwan)

Phone: +60.12.275.3307  
neasia@prosoft-technology.com  
*Languages: English, Chinese, Japanese*

### Korea

Phone: +82.10.7187.2064  
korea@prosoft-technology.com  
*Languages: English, Korean*

## Europe /M. East/Africa

### Regional Office

Phone: +33.(0)5.34.36.87.20  
europe@prosoft-technology.com  
*Languages: French, English*

### Regional Tech Support

support.emea@prosoft-technology.com

### Middle East, Turkey, Sub-Saharan Africa

Phone: +971.4.214.6911  
mea@prosoft-technology.com  
*Languages: Hindi, English*

### North Western Europe (UK, IE, IS, DK, NO, SE)

Phone: +44.(0)7415.864.902  
nweurope@prosoft-technology.com  
*Language: English*

### Austria, Germany, Switzerland

Phone: +32.474.36.84.51  
germany@prosoft-technology.com  
*Languages: French, English, Dutch*

### France, Benelux, Portugal, Algeria, Morocco, Tunisia

Phone: +32.474.36.84.51  
france@prosoft-technology.com  
*Languages: French, English, Dutch*

### Italy, Greece, Israel, Eastern Europe

Phone: +39.342.8651.595  
italy@prosoft-technology.com  
*Languages: Italian, English*

## Latin America

### Regional Office

Phone: +52.222.264.1814  
latinam@prosoft-technology.com  
*Languages: Spanish, English*

### Regional Tech Support

support.la@prosoft-technology.com

### Argentina, Bolivia, Brazil, Paraguay, Uruguay

Phone: +55.11.5084.5178  
brasil@prosoft-technology.com  
*Languages: Portuguese, English*

### Mexico, Andean, Caribbean, & Central America (VE, CO, PE, EC)

Phone: +507-6427-48-38  
mexico@prosoft-technology.com  
*Languages: Spanish, English*

## North America

### Regional Office

Phone: +1.661.716.5100  
info@prosoft-technology.com  
*Languages: English, Spanish*

### Regional Tech Support

support@prosoft-technology.com



### Support and expertise for your projects

ProSoft provides a variety of resources and services for wireless applications from initial system design to site surveys to launch support and configuration support.

**Tech Support:** support@prosoft-technology.com

Contact Us

